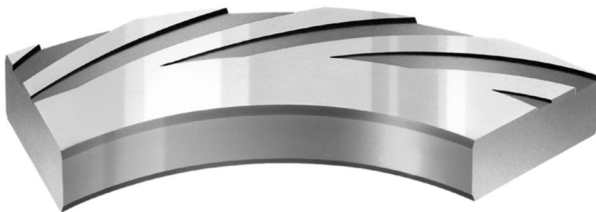
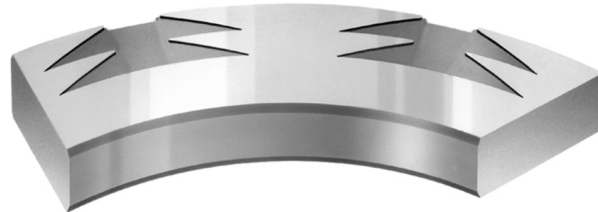
**Standard Unidirectional Groove Design****Optional Bidirectional Groove Design**

Product Description

Type 28 compressor dry-running gas seals have been the industry standard since the 1970s for gas-handling turbomachinery. Utilizing John Crane's patented spiral groove pattern, these seals are non-contacting in operation.

- During dynamic operation, the mating ring/seat and primary ring/face maintain a sealing gap of approximately 0.0002 in./5 microns, thereby eliminating wear
- These seals eliminate seal oil contamination and reduce maintenance costs and downtime
- Single, double opposed, and tandem cartridge seals are capable of handling a wide variety of gas sealing applications in the gas collection/transmission, refining, chemical and petrochemical processing industries

Design Features

- Shrouded mating ring prevents secondary damage in the event of a mating ring fracture
- Low-level leakage can be vented to a safe area, used as fuel to drive equipment, or returned to process via a low-pressure ejector

Performance Capabilities

- Temperature: -220°F to 600°F/-140°C to 315°C
- Pressure: Up to 6,500 psi(g)/450 bar(g) across single stage
- Speed: Up to 660 fps/200 m/s
- Shaft: Up to 13.75"/350mm

TYPE 28

DRY-RUNNING, NON-CONTACTING GAS SEALS

Type 28AT Tandem Arrangement

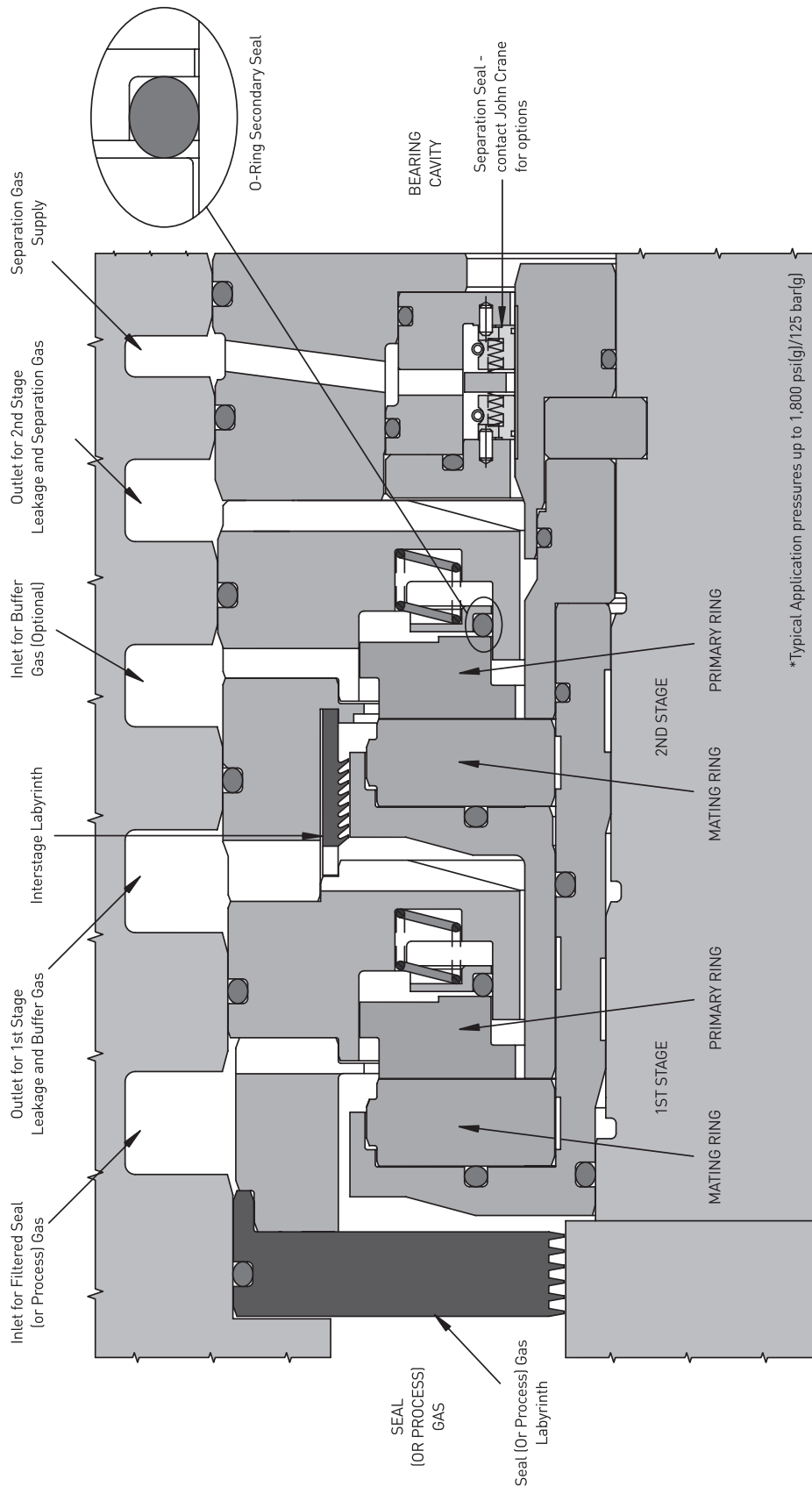

TYPE 28

DRY-RUNNING, NON-CONTACTING GAS SEALS

Type 28XP Tandem Arrangement

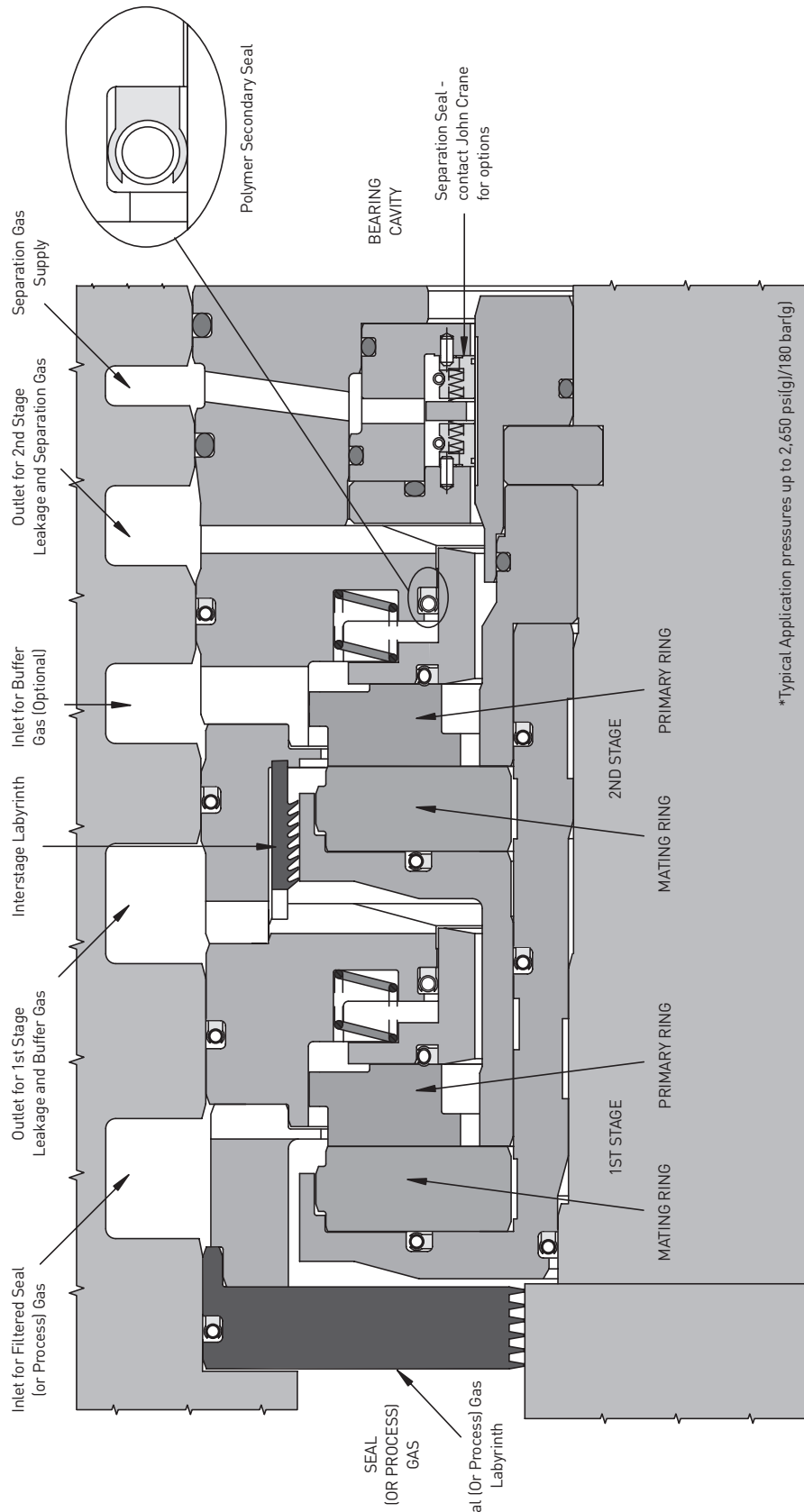

TYPE 28

DRY-RUNNING, NON-CONTACTING GAS SEALS

Type 28XP-S Tandem Arrangement

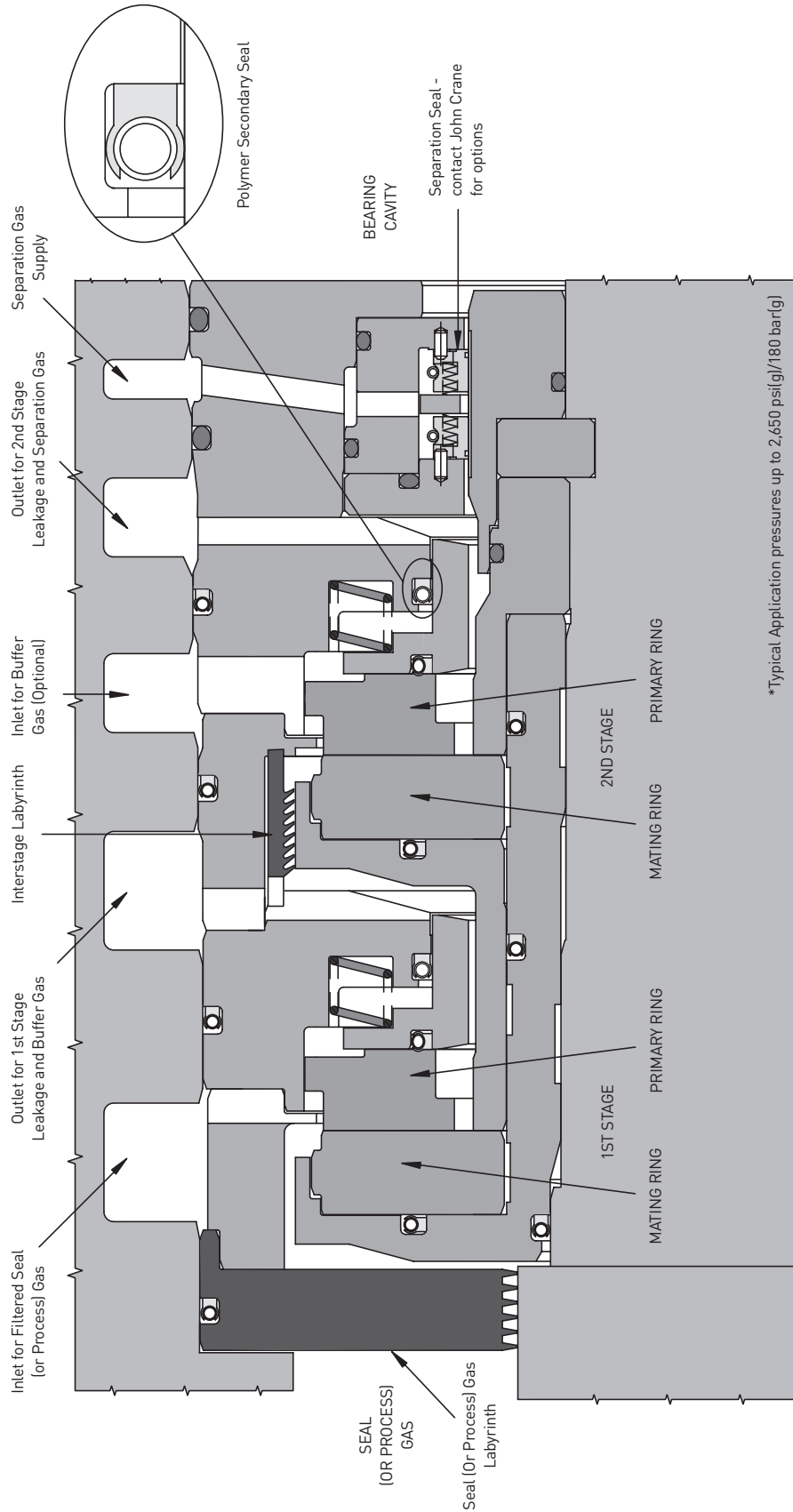

TYPE 28

DRY-RUNNING, NON-CONTACTING GAS SEALS

Type 28EXP Tandem Arrangement

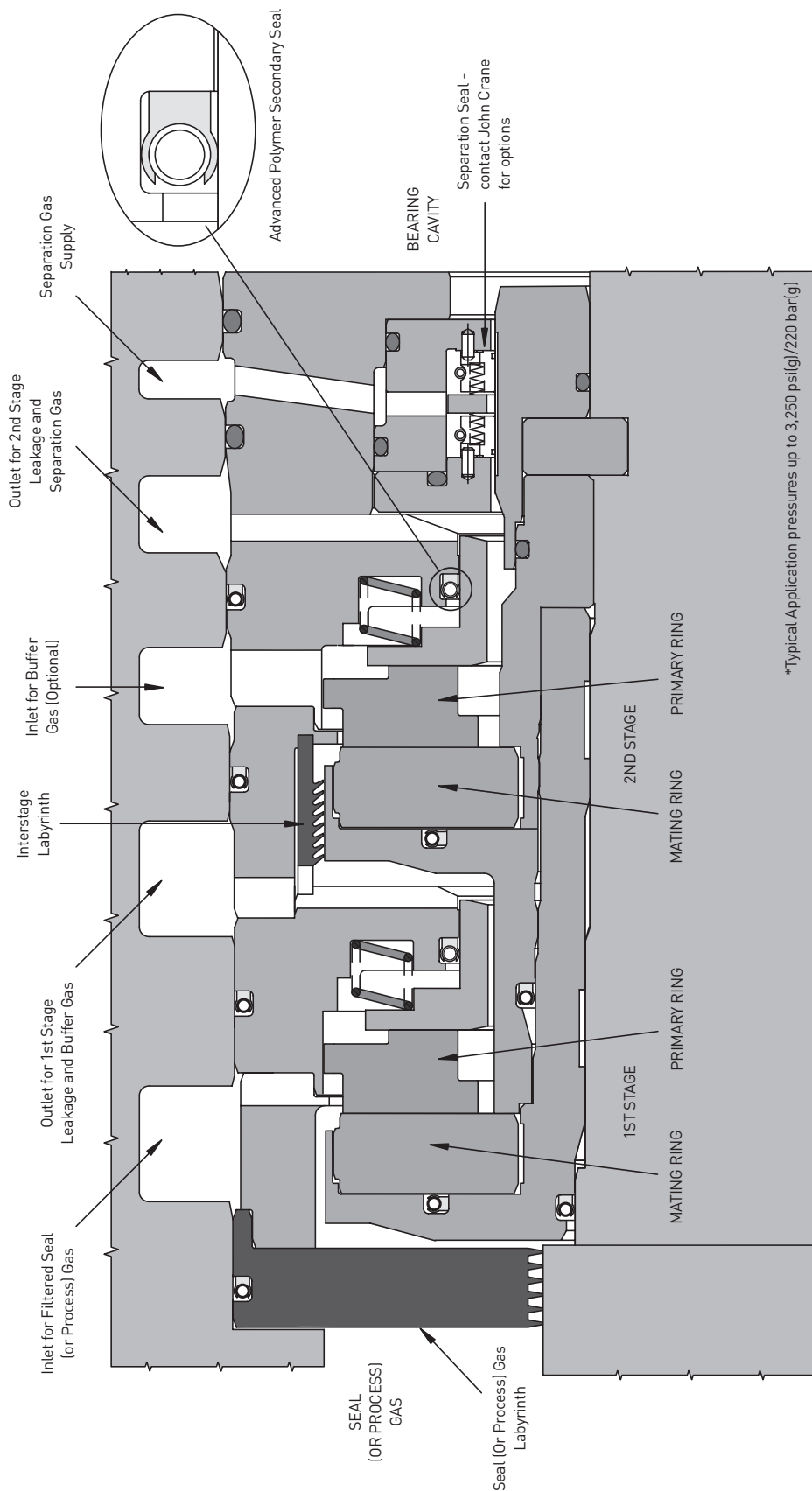

Typical Single Seal Arrangement and Seal Support System

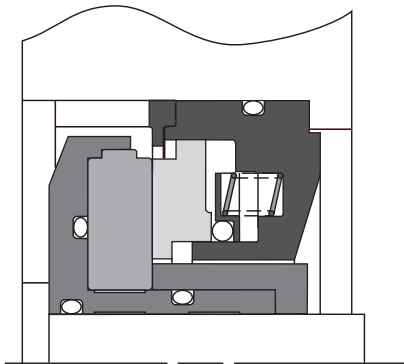

*Single Seal Arrangement for applications not requiring a safety back-up seal.

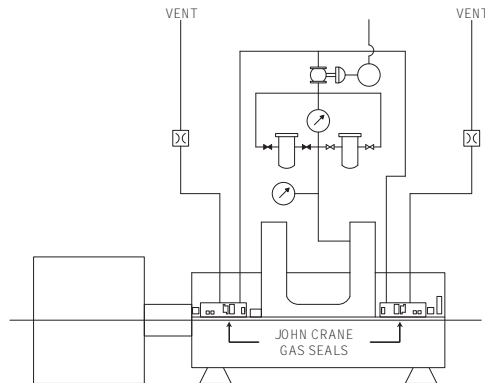

Typical Double Opposed Seal Arrangement and Seal Support System

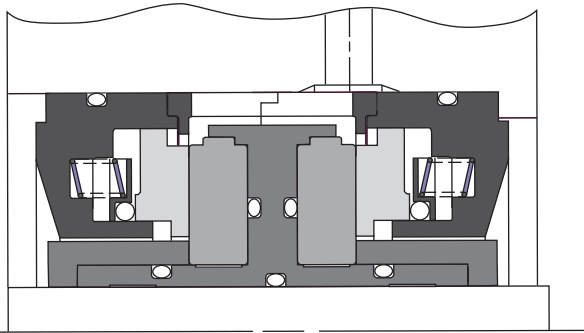

*Double Seal Arrangement where hazardous gas is not permissible to leak into atmosphere.

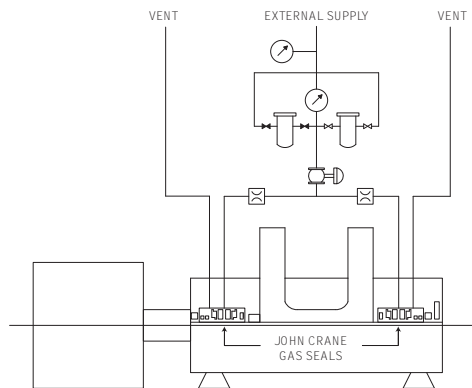

Typical Tandem Seal Arrangement and Seal Support System

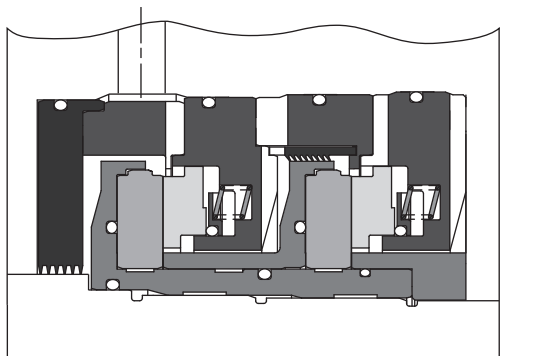

*Tandem Seal Arrangement for applications requiring a safety back-up seal.

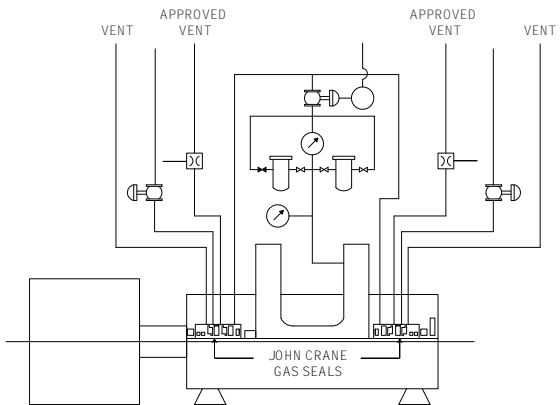

Size and Speed Effect on Leakage

Conditions: Air, 1,200 psig/83 bar g

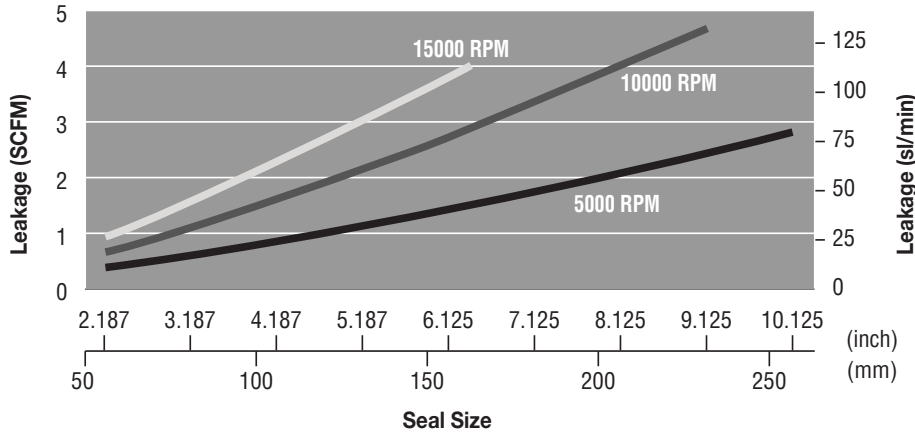

Pressure, Temperature and Gas Effect on Leakage

Conditions: 6.187-inch Diameter Seal, 14,000 rpm

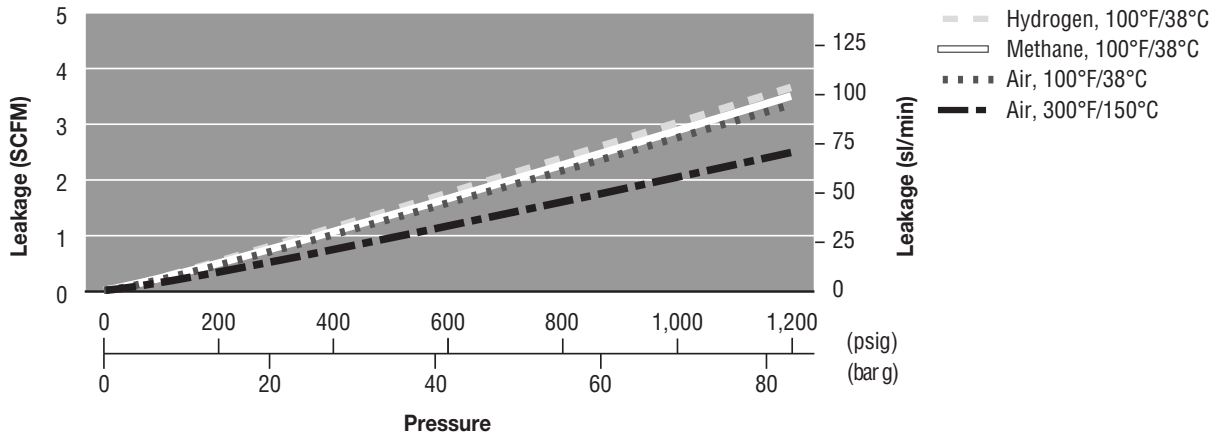

Gas Seal Power Consumption

Conditions: Air, 140°F/60°C

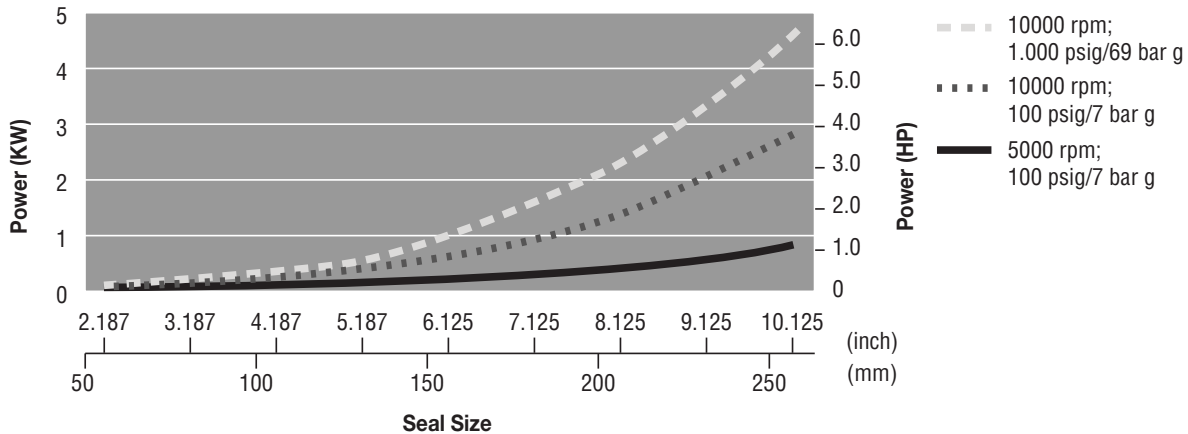

*This information should not be used for specification purposes. Contact DryGasSeals@johncrane.com for more information about exact application requirements.



North America	Europe	Latin America	Middle East & Africa	Asia Pacific
United States of America	United Kingdom	Brazil	United Arab Emirates	Singapore
Tel: 1-847-967-2400	Tel: 44-1753-224000	Tel: 55-11-3371-2500	Tel: 971-481-27800	Tel: 65-6518-1800
Fax: 1-847-967-3915	Fax: 44-1753-224224	Fax: 55-11-3371-2599	Fax: 971-488-62830	Fax: 65-6518-1803

If the products featured will be used in a potentially dangerous and/or hazardous process, your John Crane representative should be consulted prior to their selection and use. In the interest of continuous development, John Crane Companies reserve the right to alter designs and specifications without prior notice. It is dangerous to smoke while handling products made from PTFE. Old and new PTFE products must not be incinerated. ISO 9001 and ISO14001 Certified, details available on request.