

Standardised Water Pump and Hot
Water Pump

50 Hz

Volcano

Vlet



Characteristic Curves Booklet

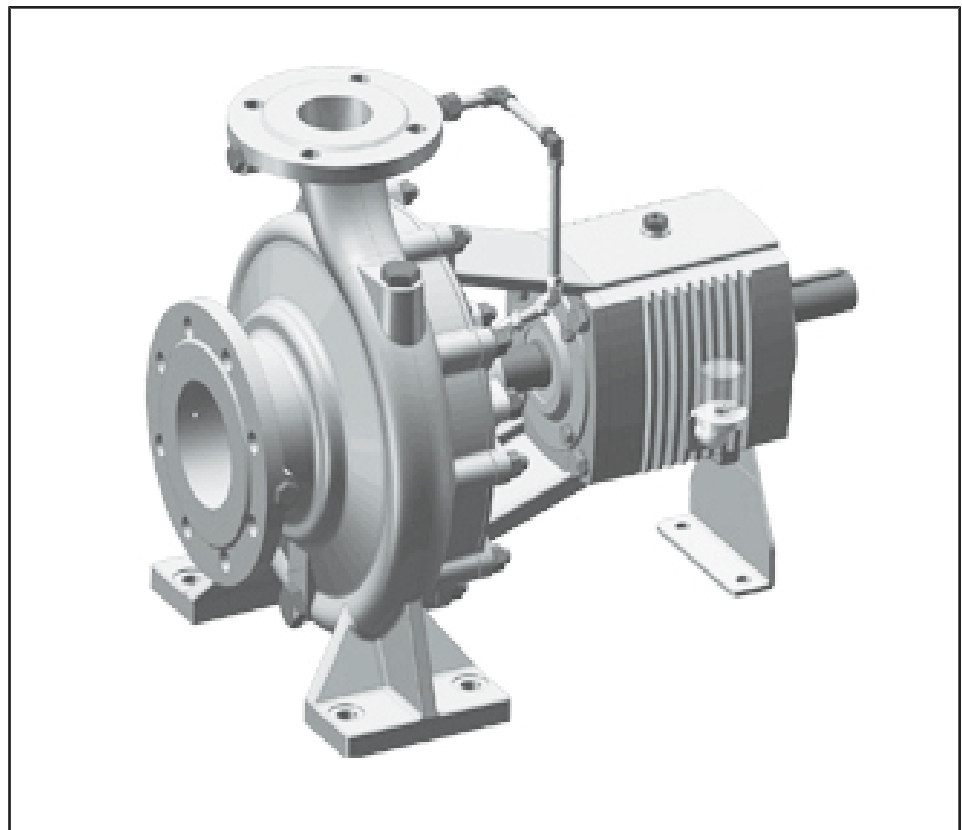

Contents

Centrifugal Pumps with Shaft Seal.

General	3
Selection chart n=2900	4
Selection chart n=1450	5
Selection chart n=960	6
Chart Vlet n=2900	7
Chart Vlet n=1450	41
Chart Vlet N=950	103
Dimension	165
Assembly drawing	166
Pump exploded	167

Pump case

The pump case is of rigid design with a generous wall thickness, giving good protection against erosion and corrosion.

Shaft sealing

Shaft sealing can be with:
- soft packing
- mechanical seal.

Shaft bearing bracket

The heavy duty console with incorporated lantern assures silent operation.

Impeller

Fully enclosed, single -piece casting gives reliability, long trouble-free operation and high efficiency.

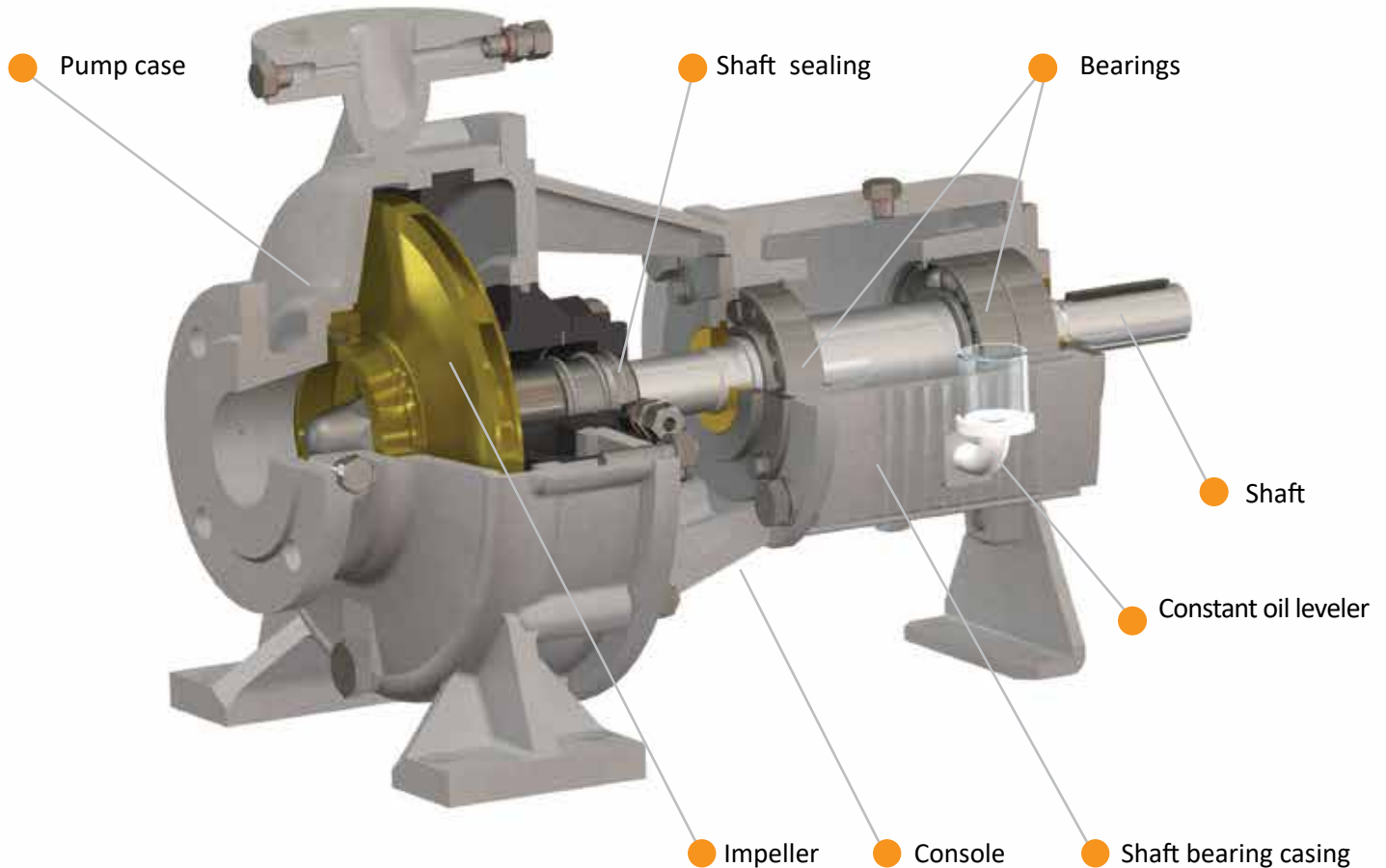

Bearings

The shaft is protected by a replaceable shaft sleeve in stainless steel.

Shafts

Ample dimensioned single and double row ball bearings improve the stiffness and minimize shaft deflection.

Console

Aligned between the bearing bracket and the pump case.

Constant oil level

For maintaining a constant oil level for efficient lubrication of the bearings.

Technical data:

Capacity: up to 1368 m³/h
Head: up to 160 m
Pump size: up to DN300
Temperature: up to 160°C
Pressure: 16 bar

Selection charts

Vlet, n = 2900 rpm

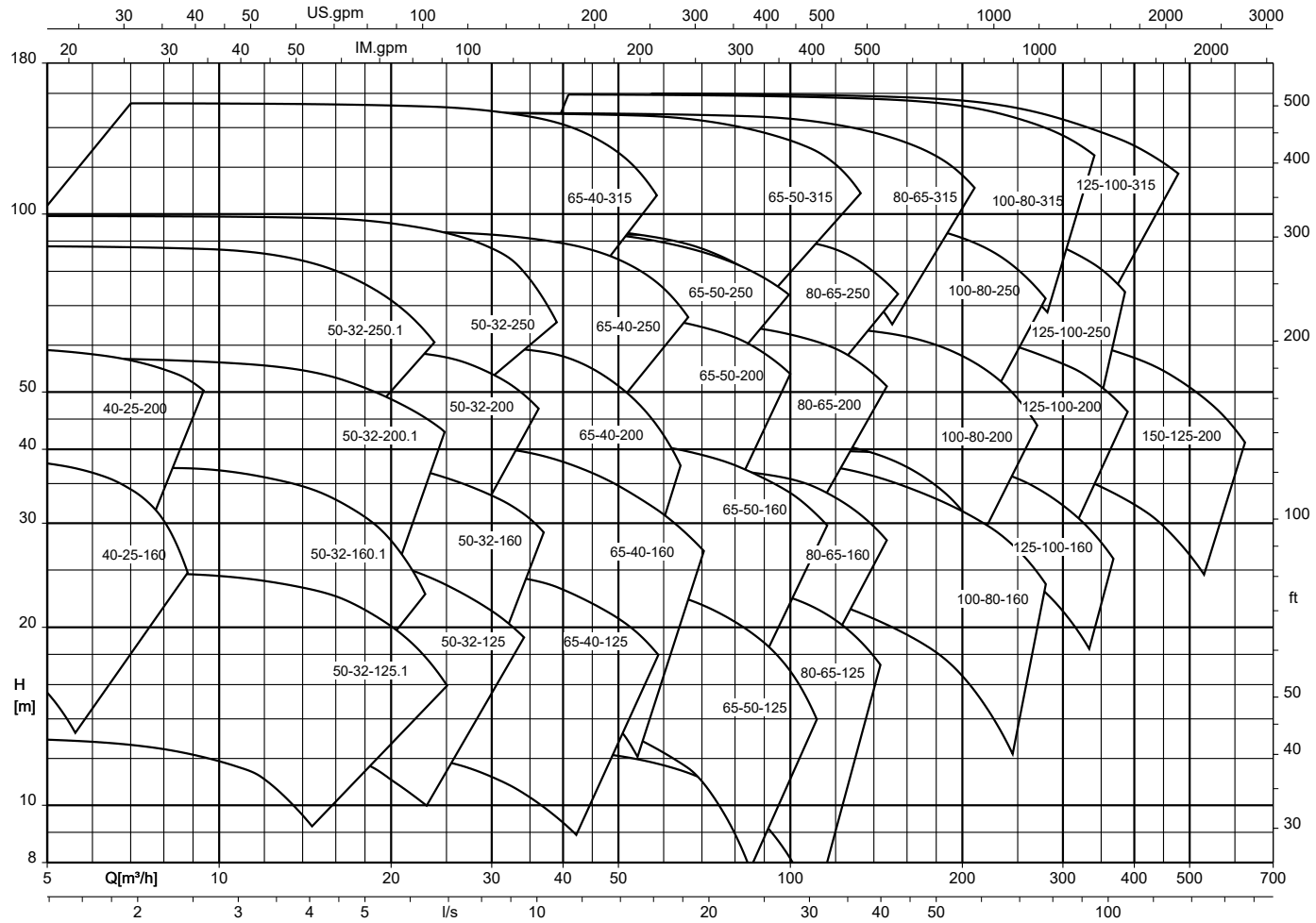

Vlet, n = 1450 rpm

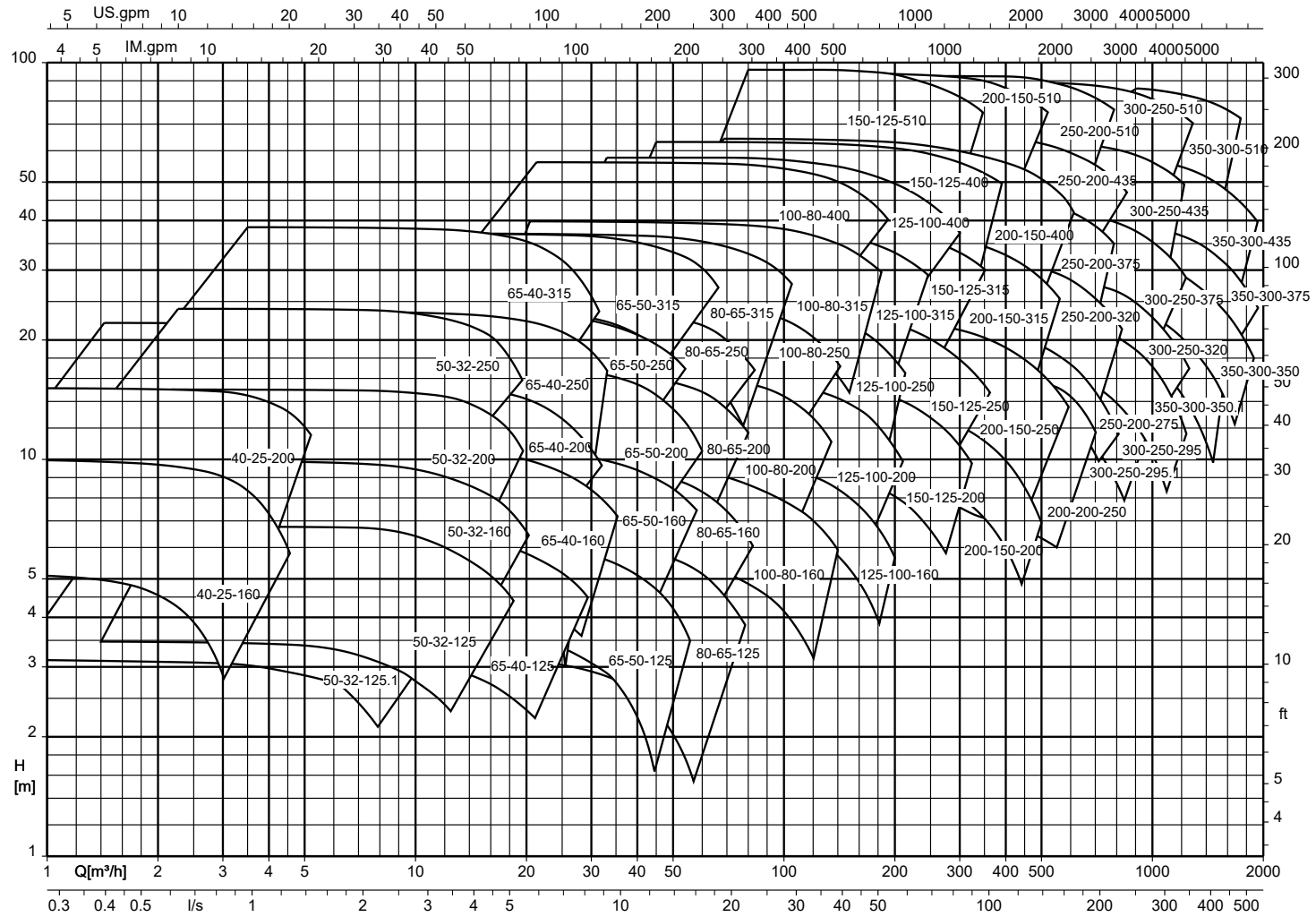

Centrifugal Pumps with Shaft Seal
Standardised Water Pump / Thermal Oil and Hot Water Pump

Vlet, n = 960 rpm

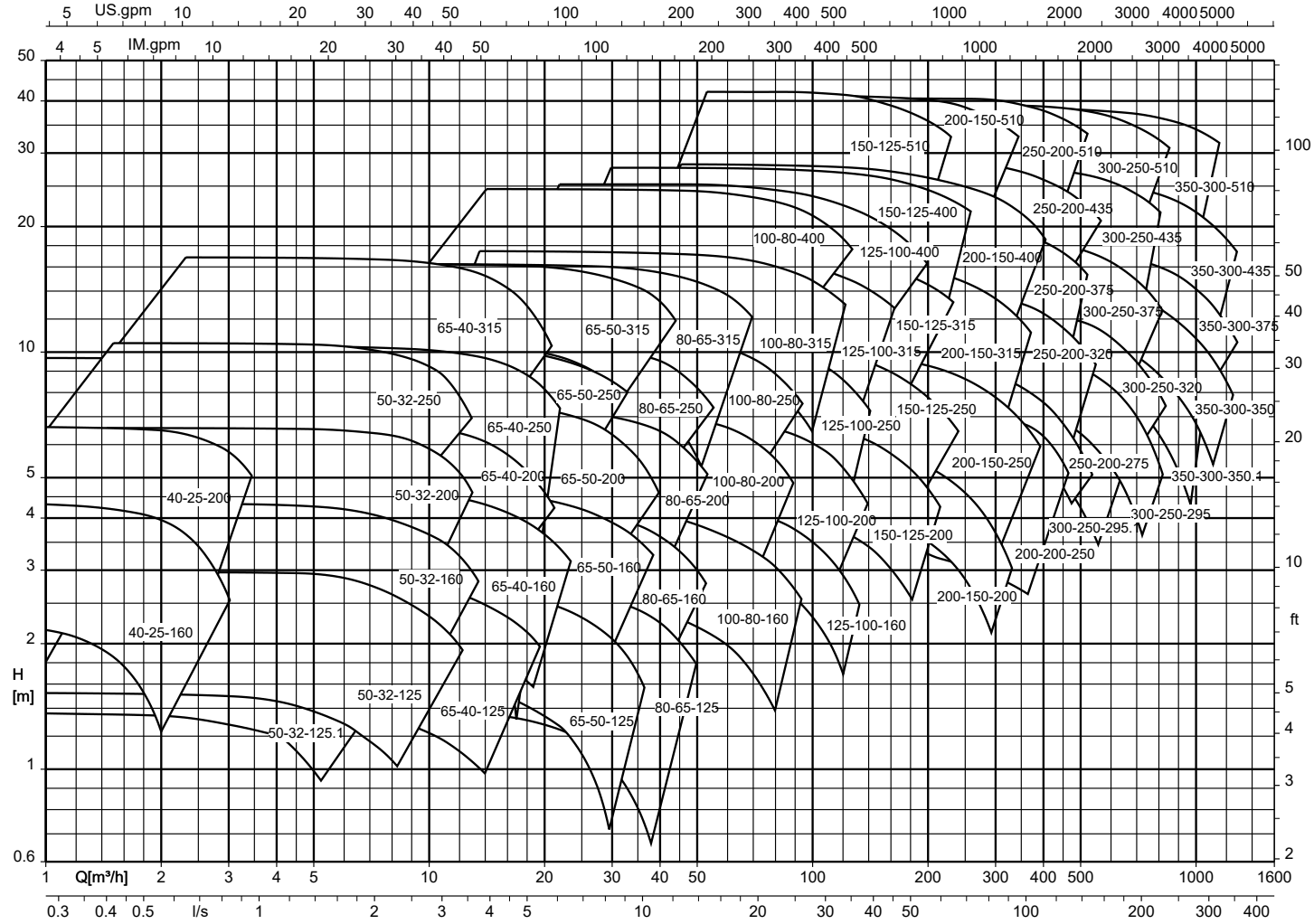

Characteristic curves

n = 2900 rpm

Vlet 040-025-160, n = 2900 rpm

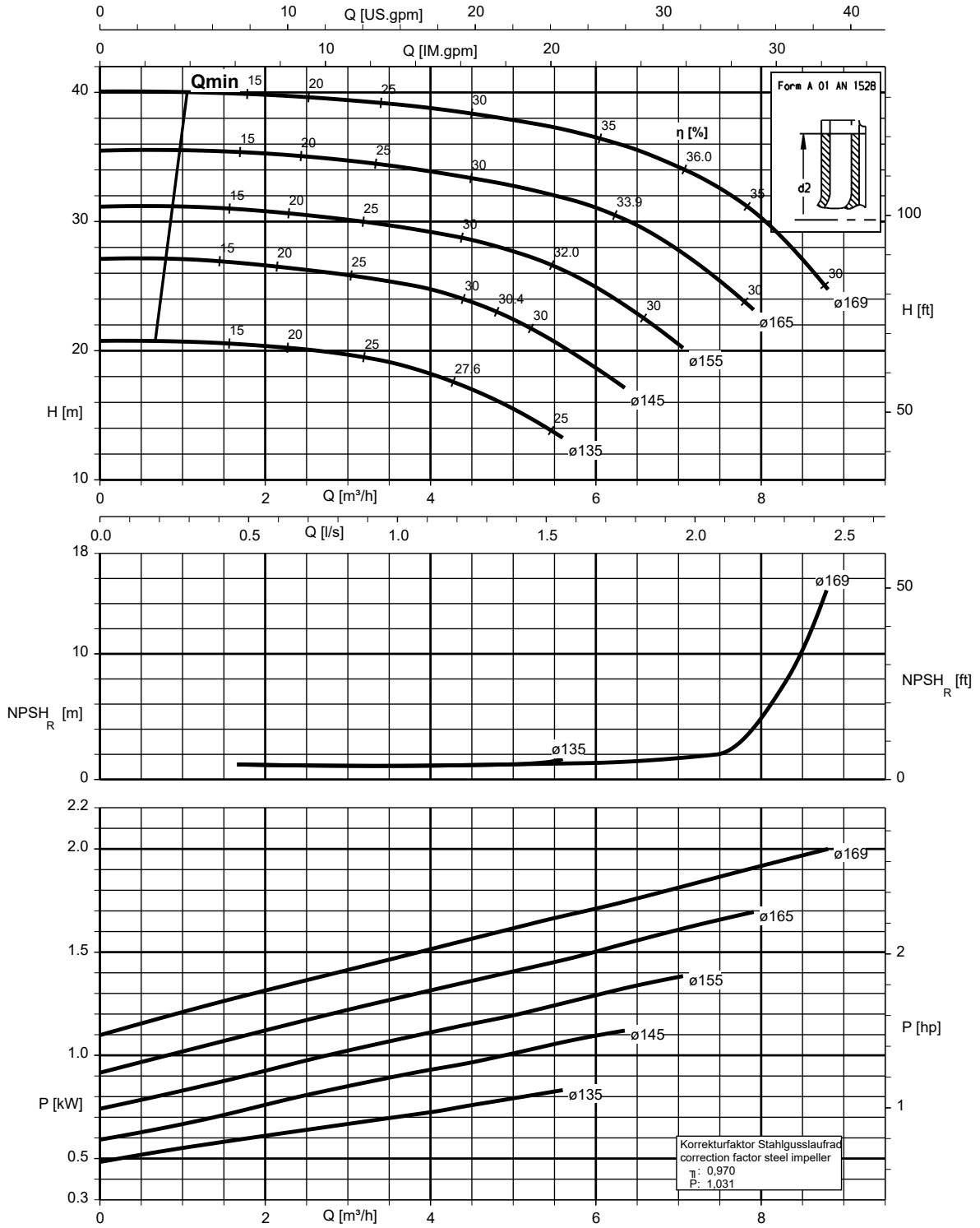

K1311.452/14/2

1311.45/11-EN

Vlet 040-025-200, n = 2900 rpm

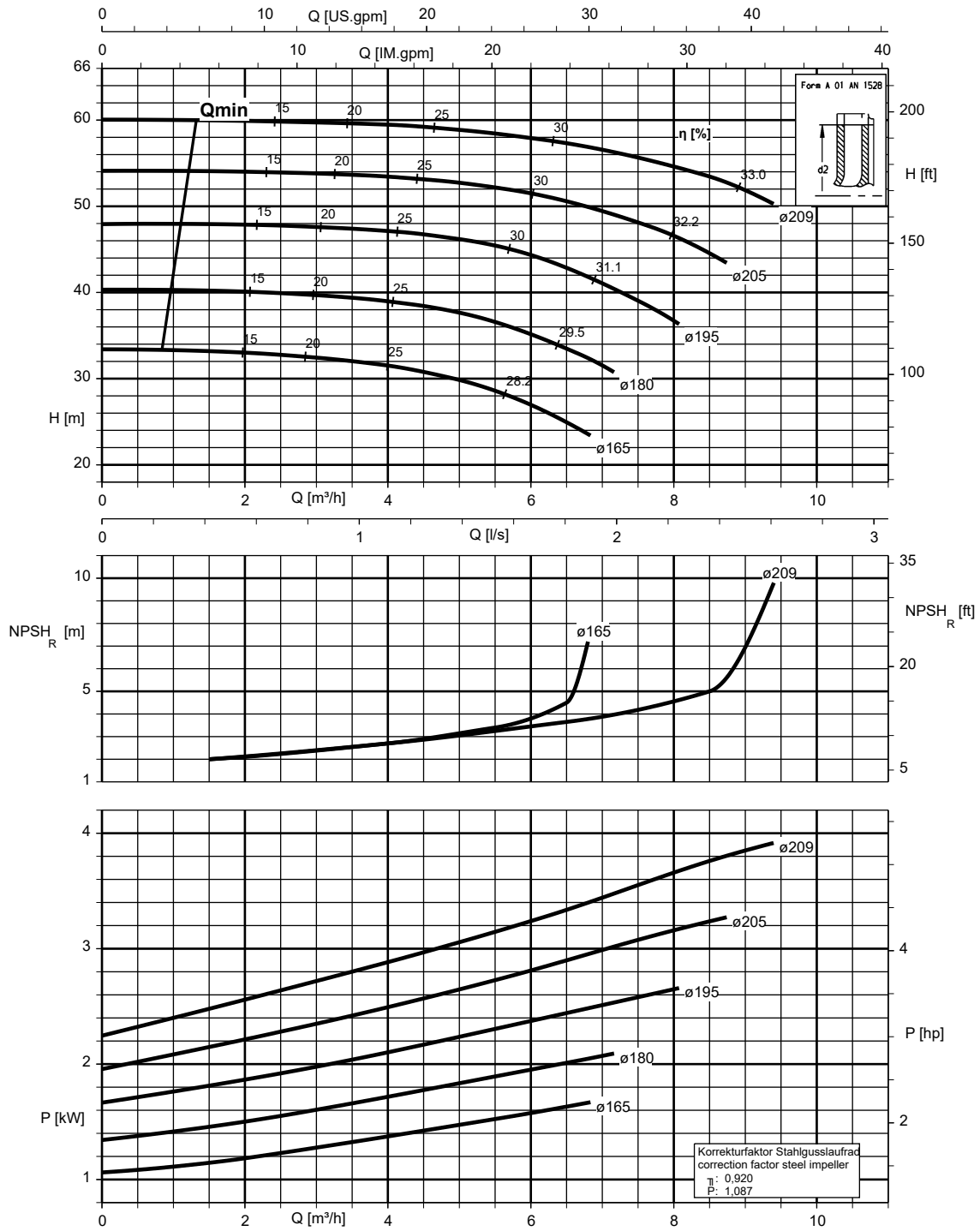

K1311/452/15/2

Vlet 050-032-125.1, n = 2900 rpm

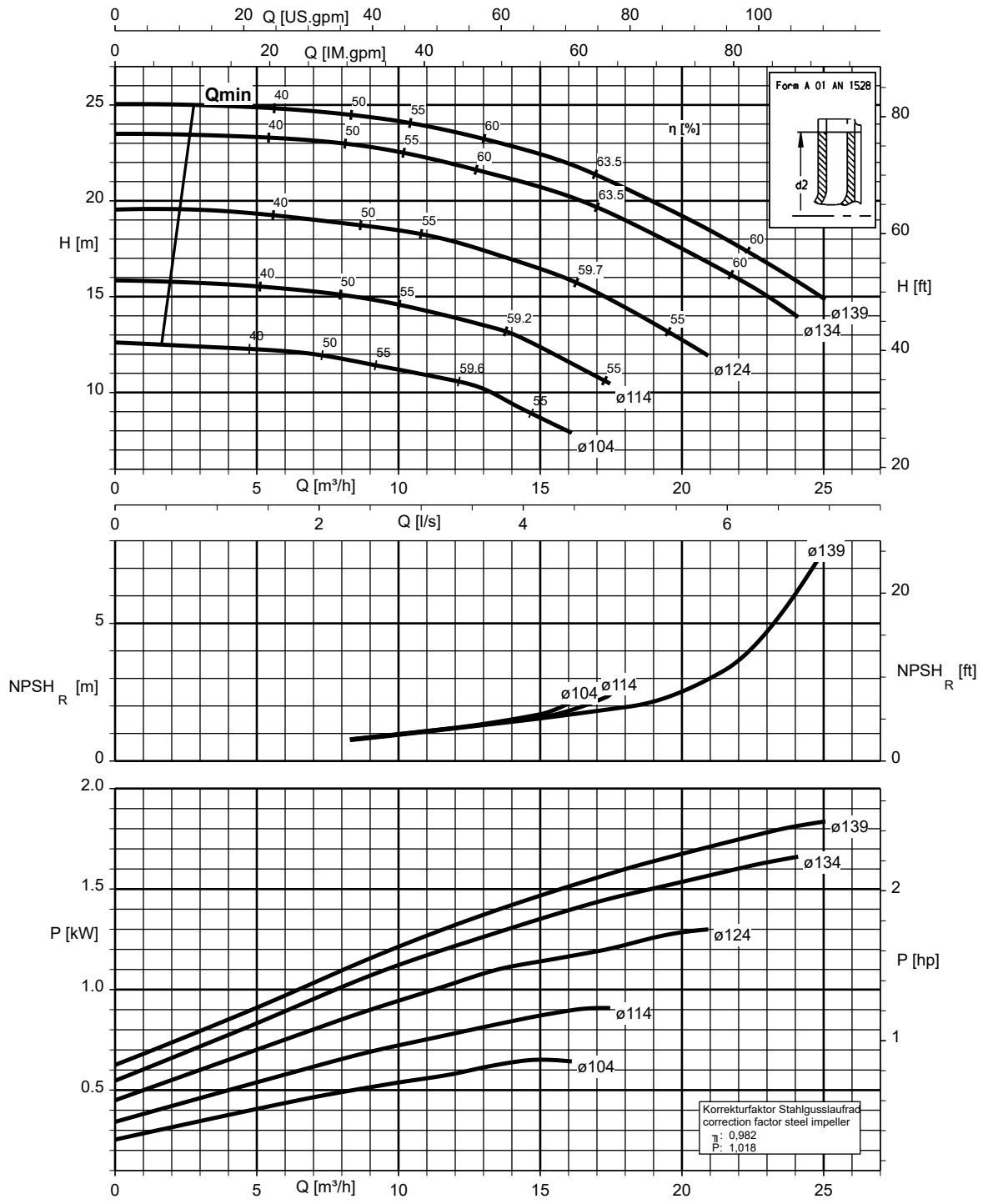

K1311.452/17/2

Vlet 050-032-160.1, n = 2900 rpm

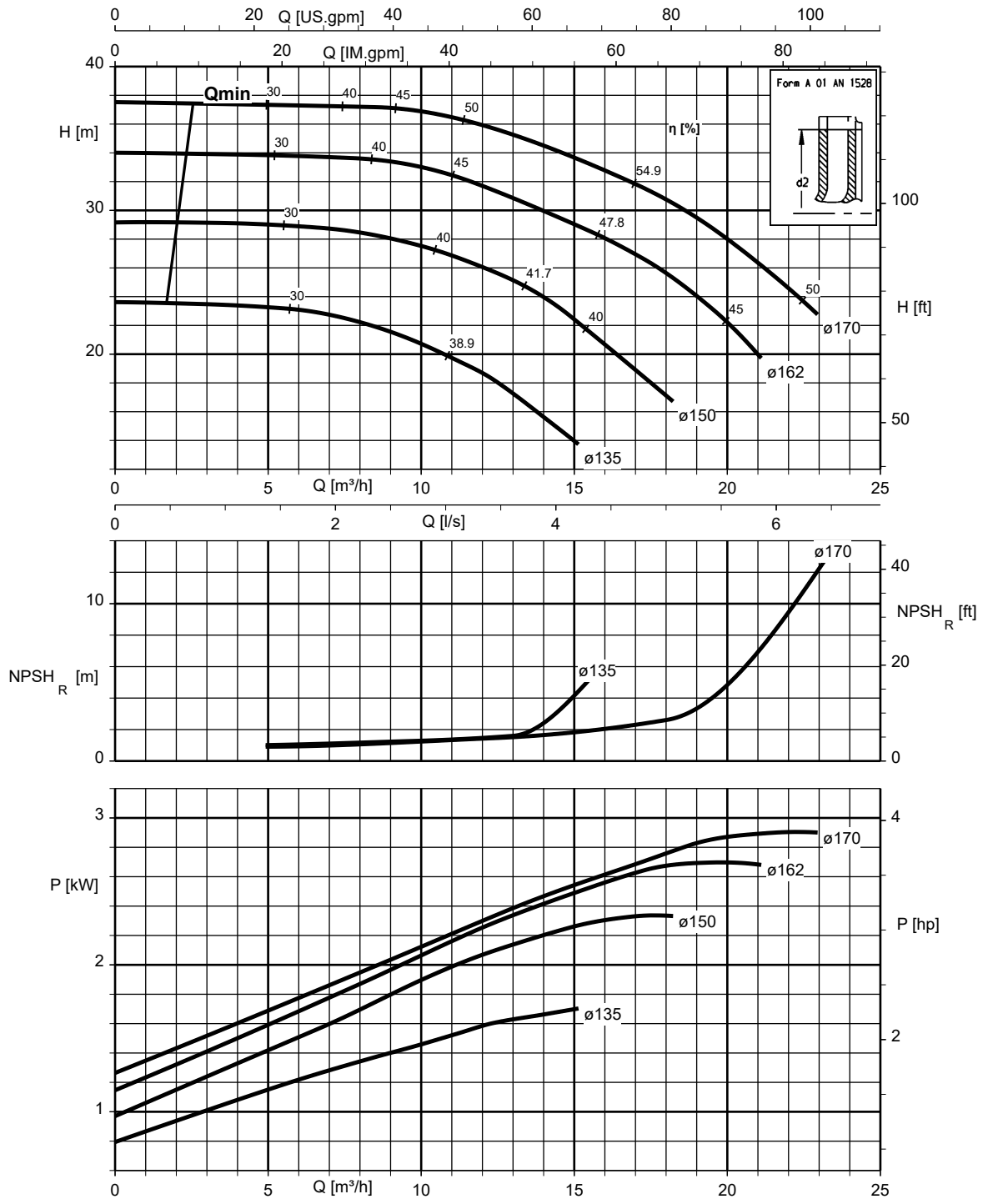

K1311.452/18/2

Vlet 050-032-200.1, n = 2900 rpm

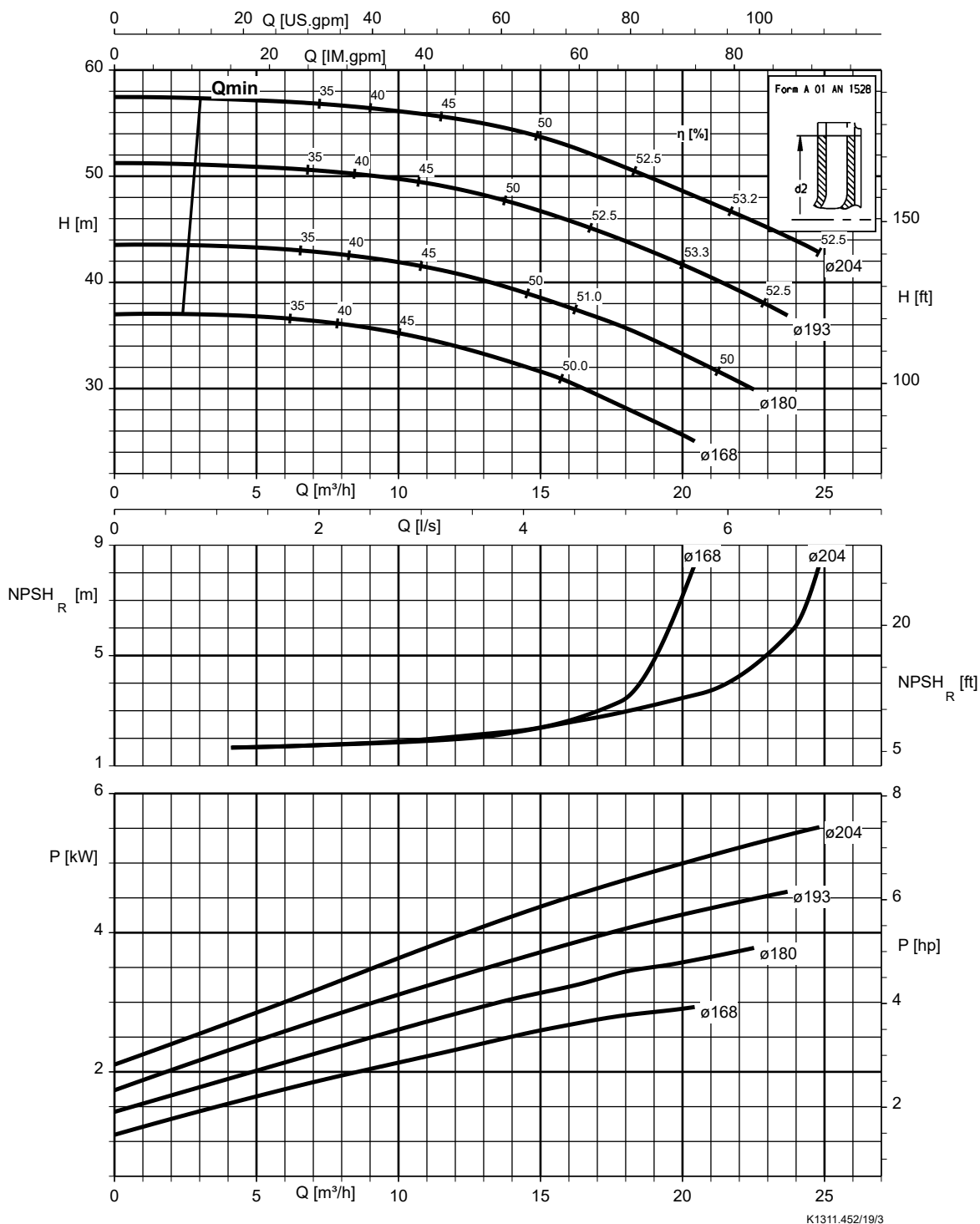

Vlet 050-032-250.1, n = 2900 rpm

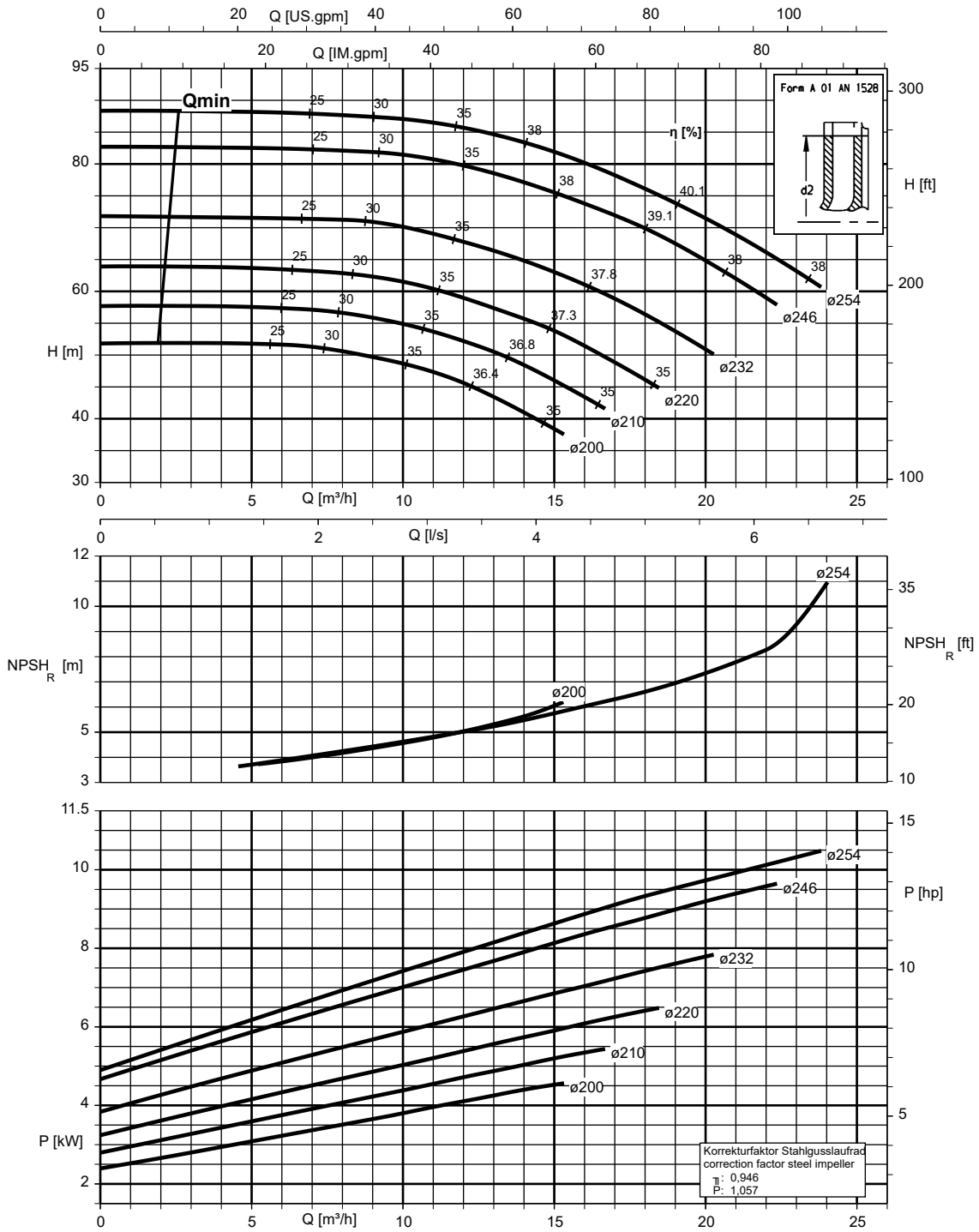

Vlet 050-032-125, n = 2900 rpm

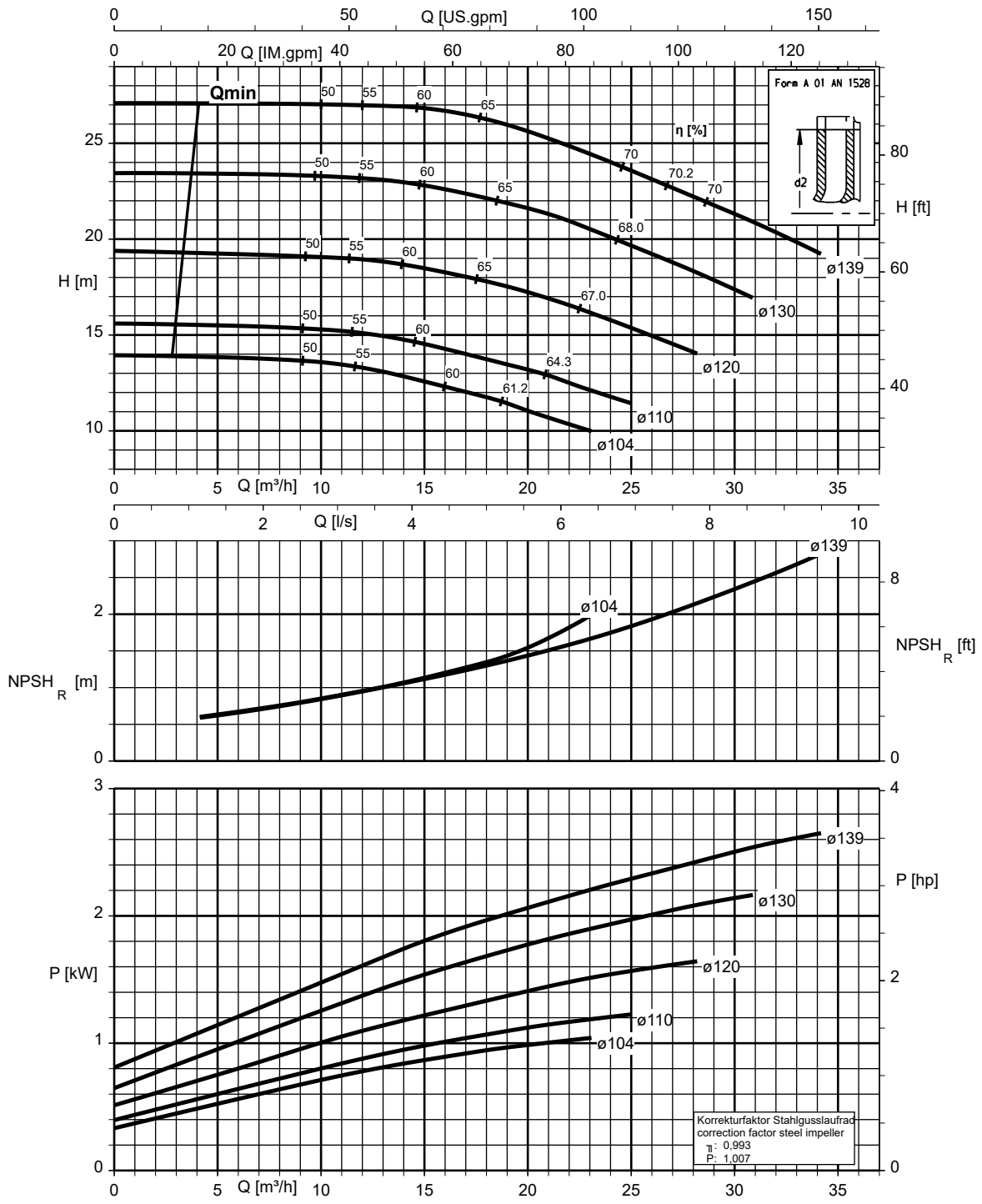

Vlet 050-032-160, n = 2900 rpm

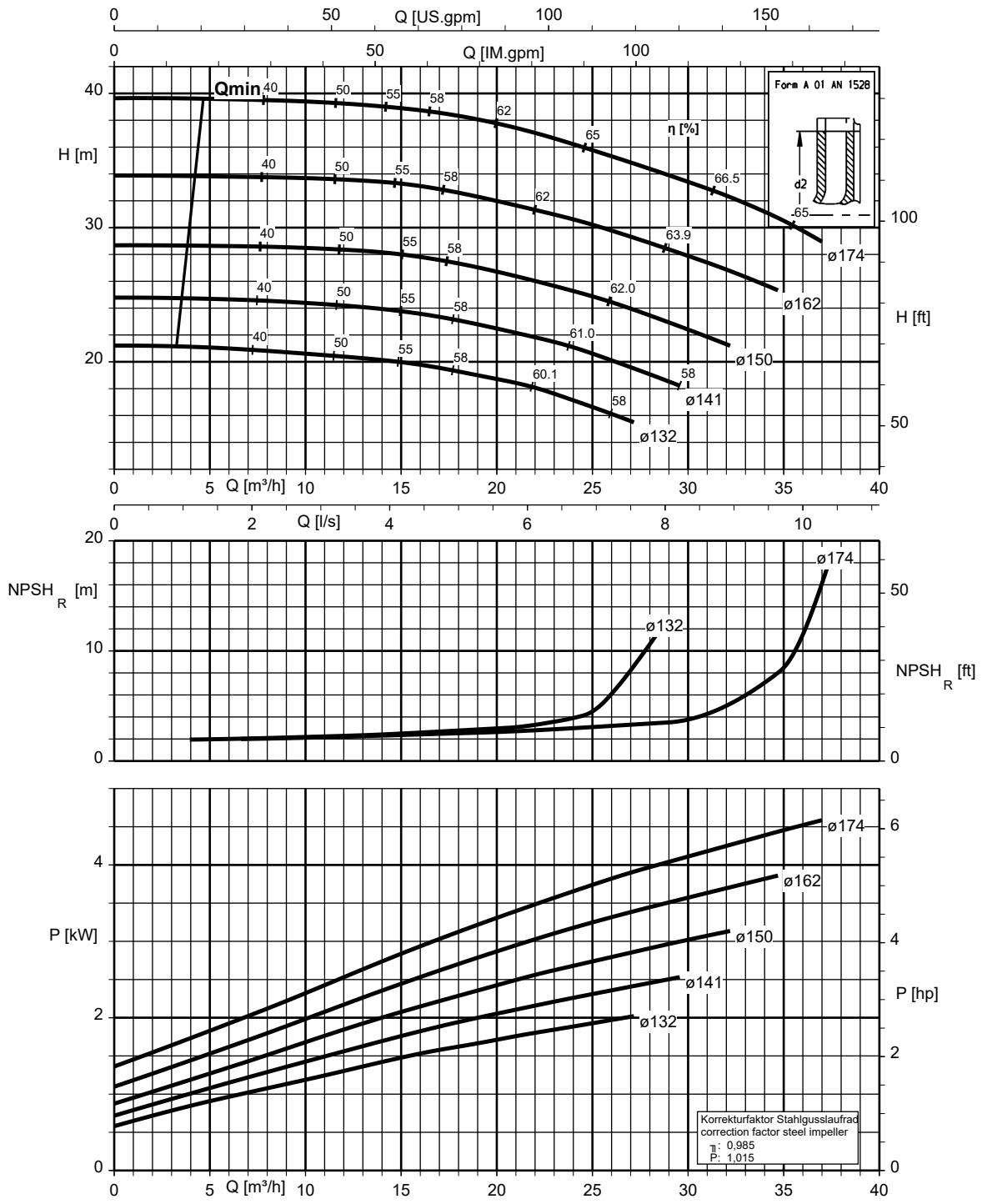

Vlet 050-032-200, n = 2900 rpm

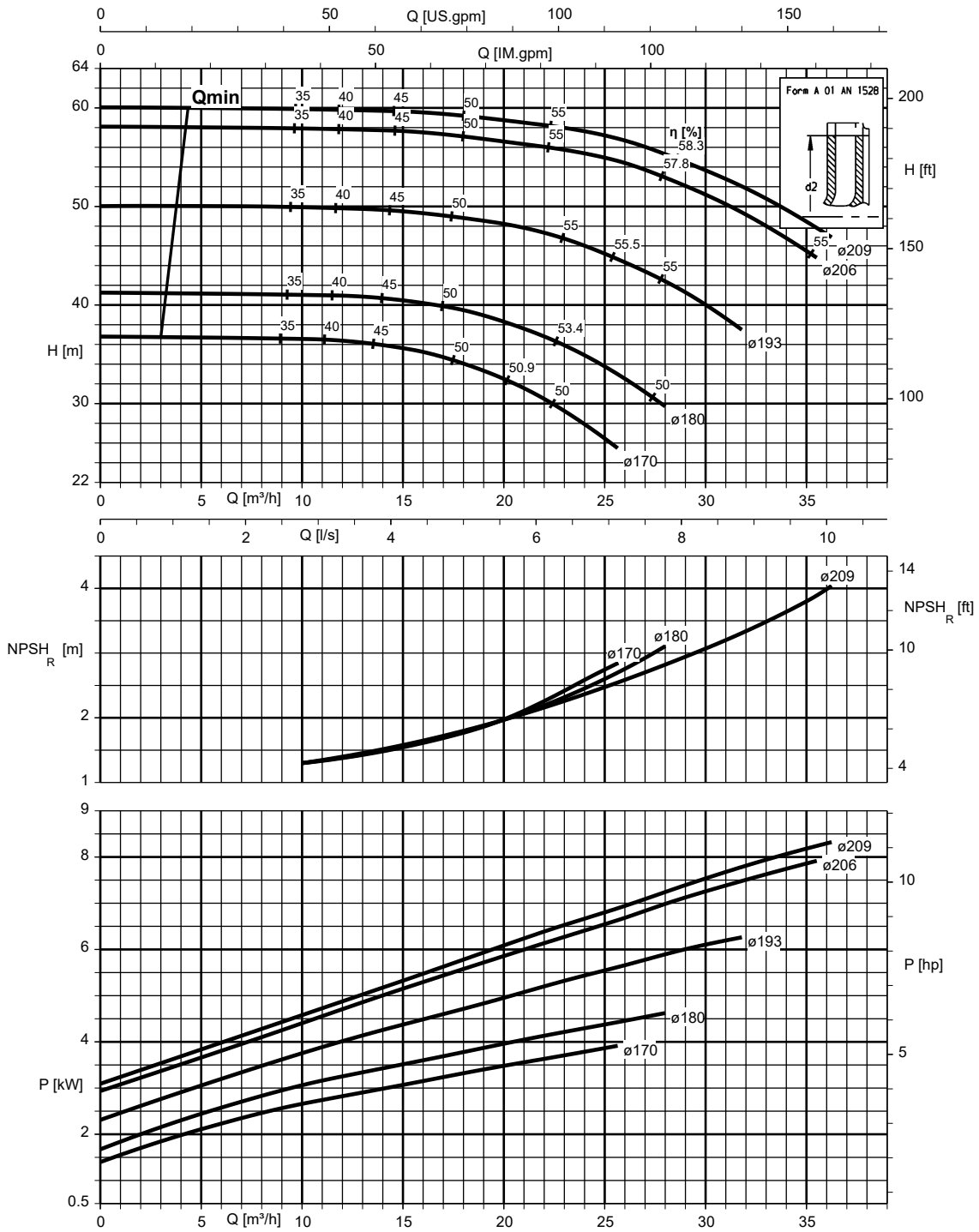

K1311.452/23/1

Vlet 050-032-250, n = 2900 rpm

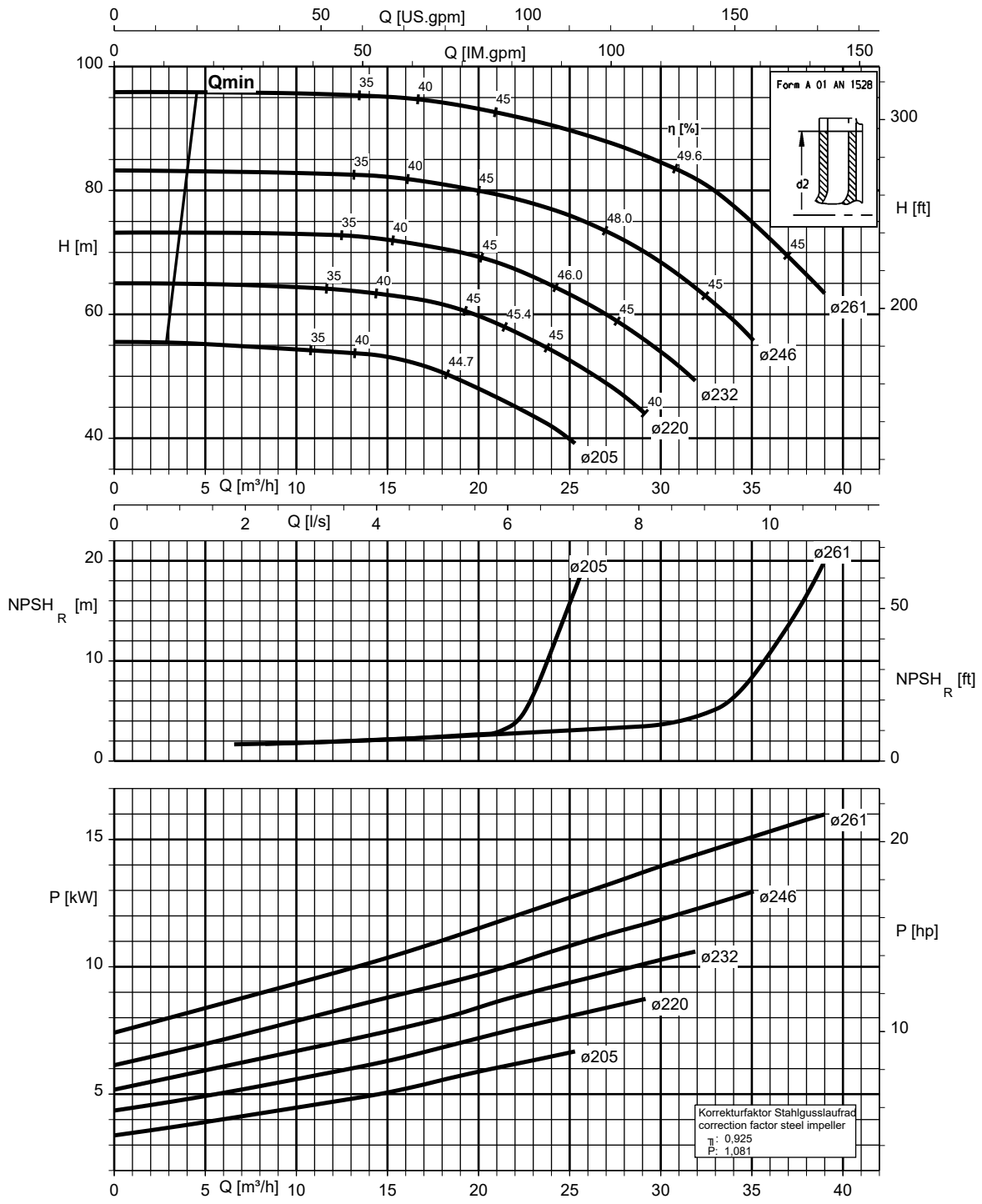

Vlet 065-040-125, n = 2900 rpm

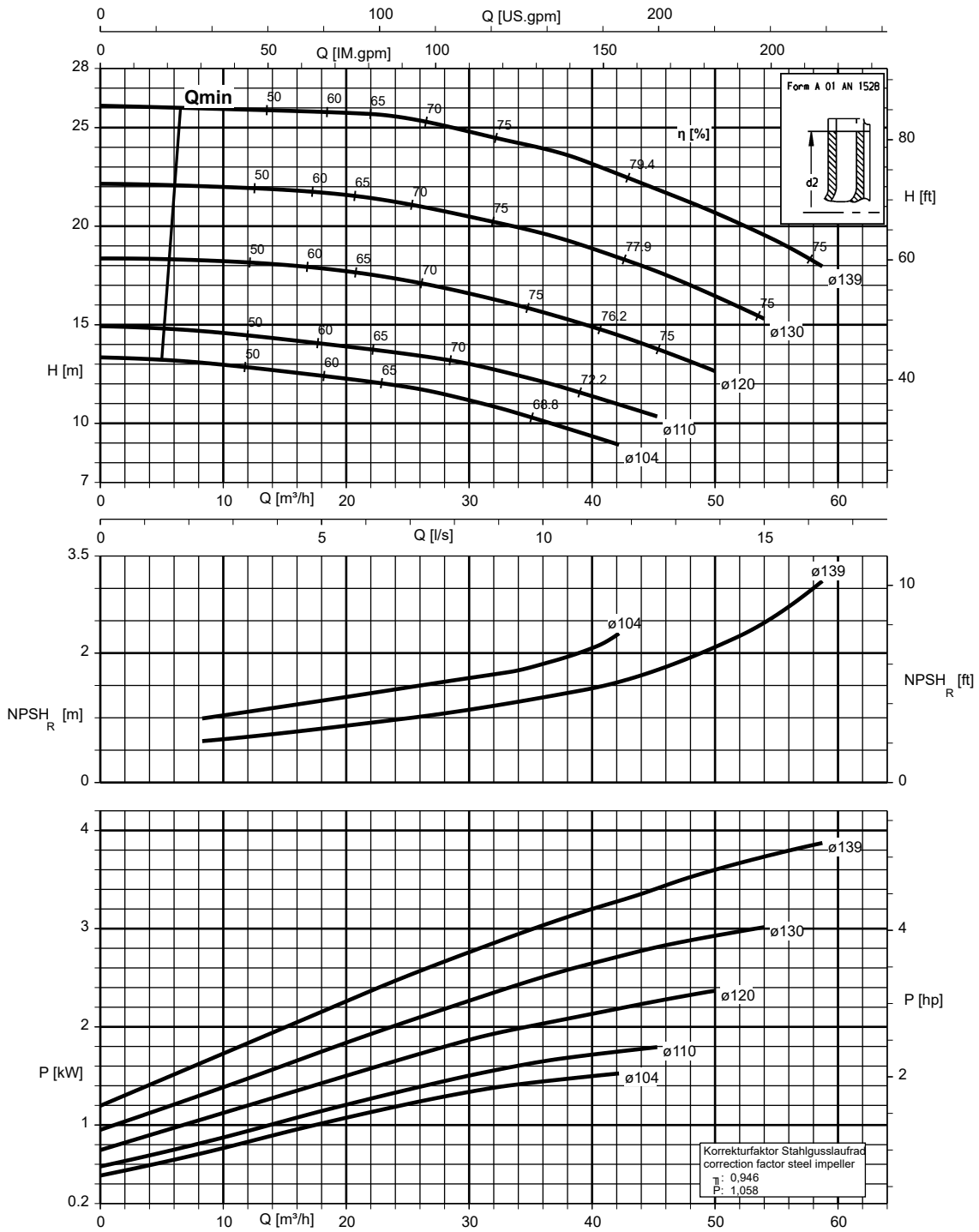

K1311.452/25/1

Vlet 065-040-160, n = 2900 rpm

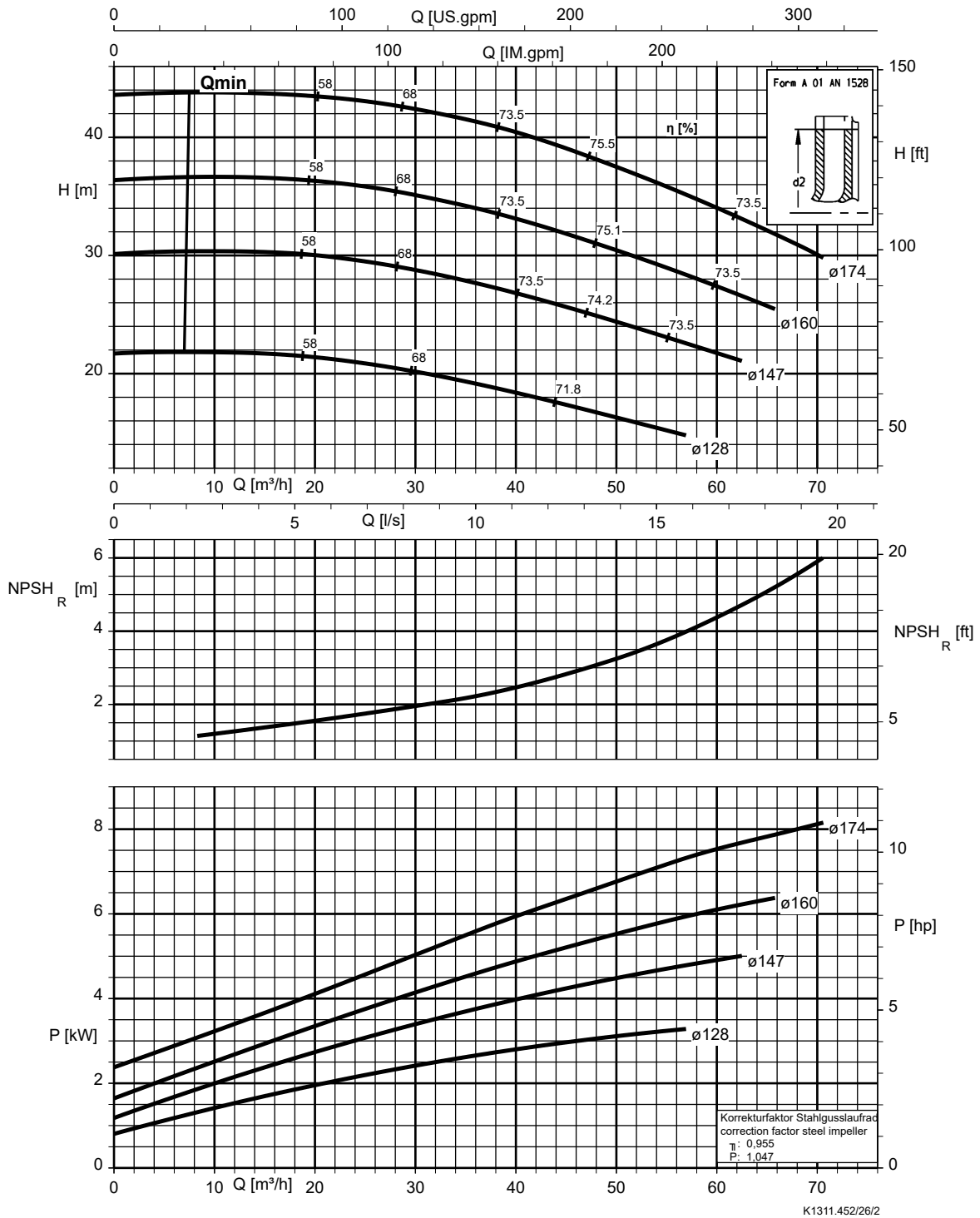

Vlet 065-040-200, n = 2900 rpm

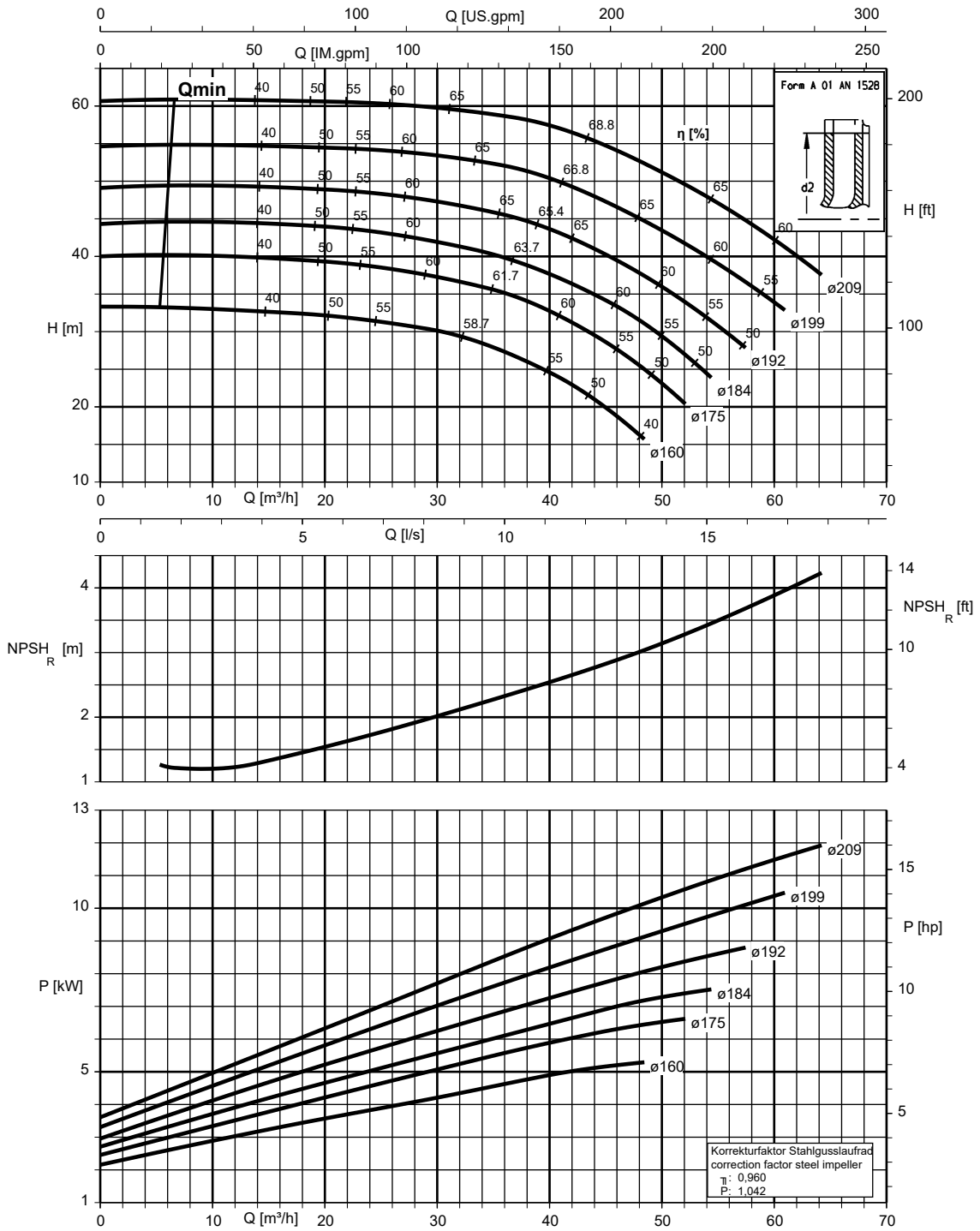

Vlet 065-040-250, n = 2900 rpm

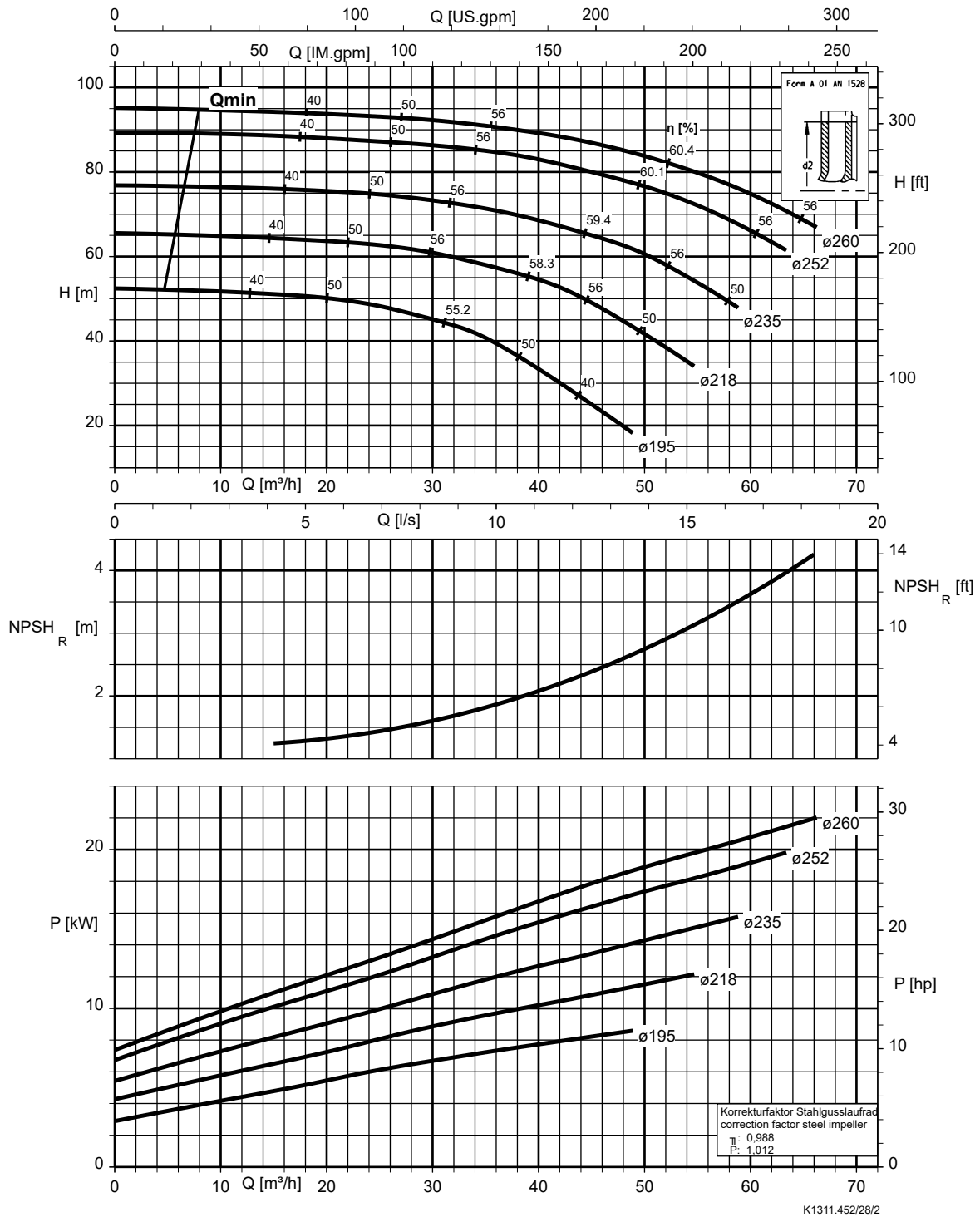

Vlet 065-040-315, n = 2900 rpm

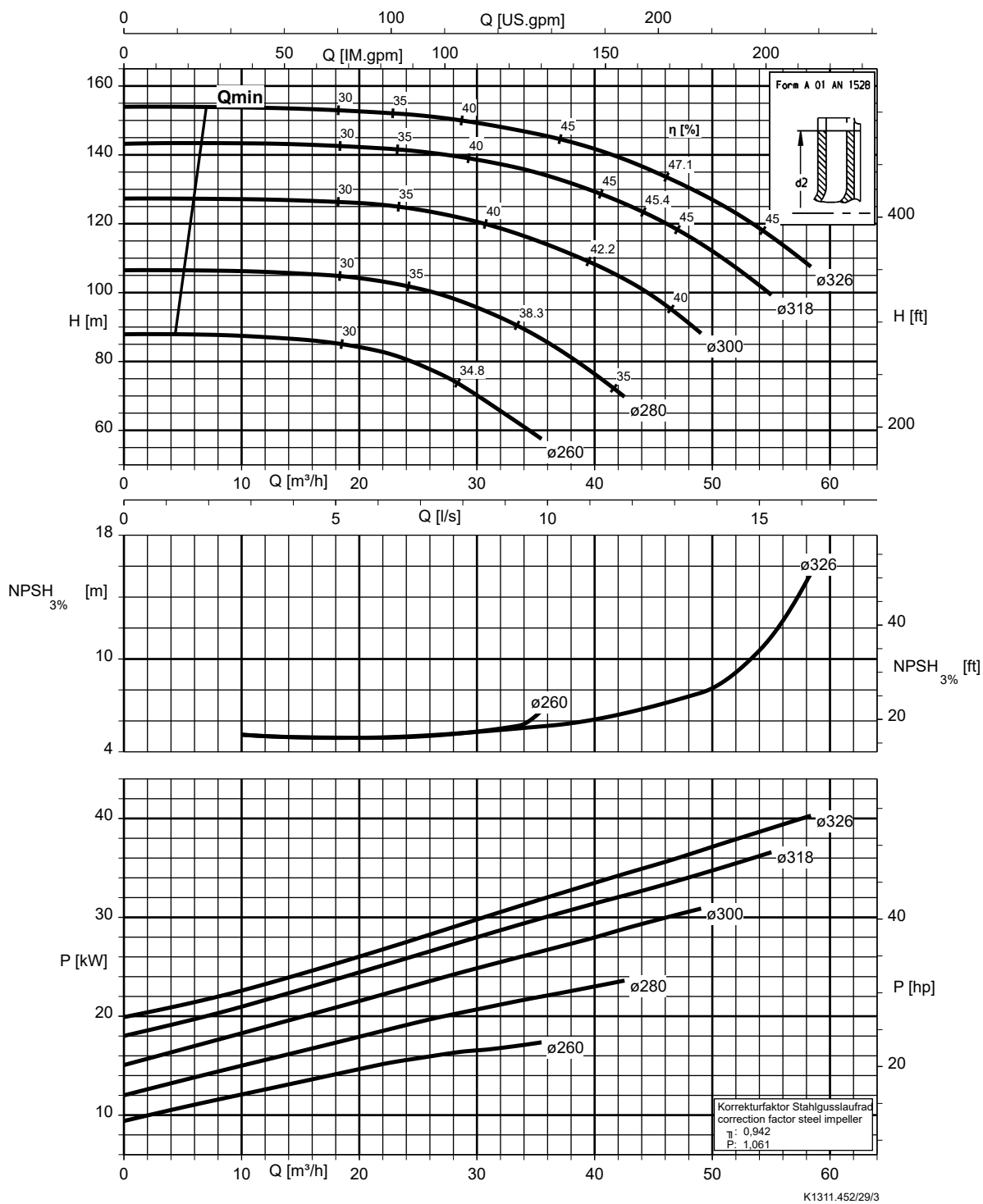

Vlet 065-050-125, n = 2900 rpm

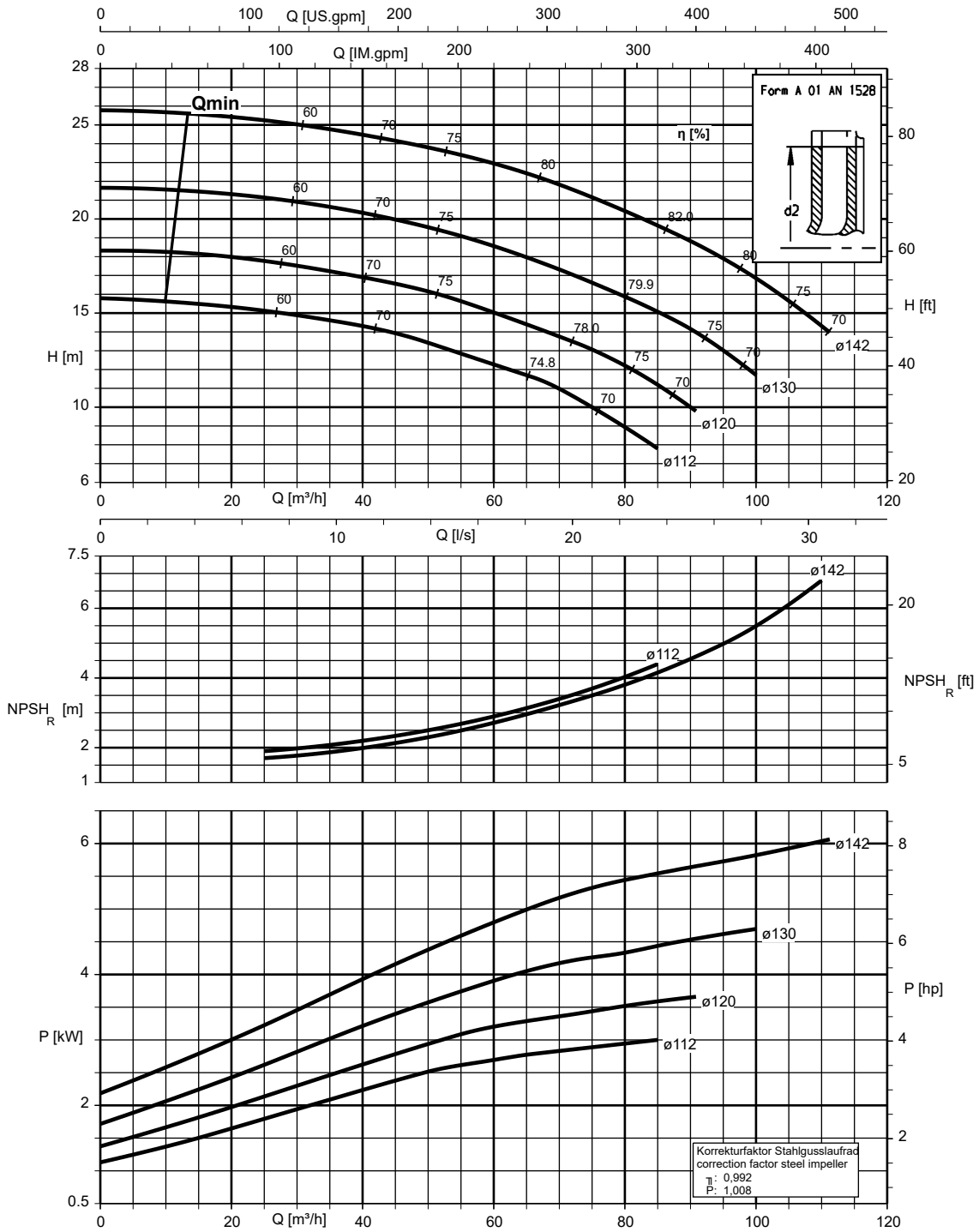

K1311.452/30/1

Vlet 065-050-160, n = 2900 rpm

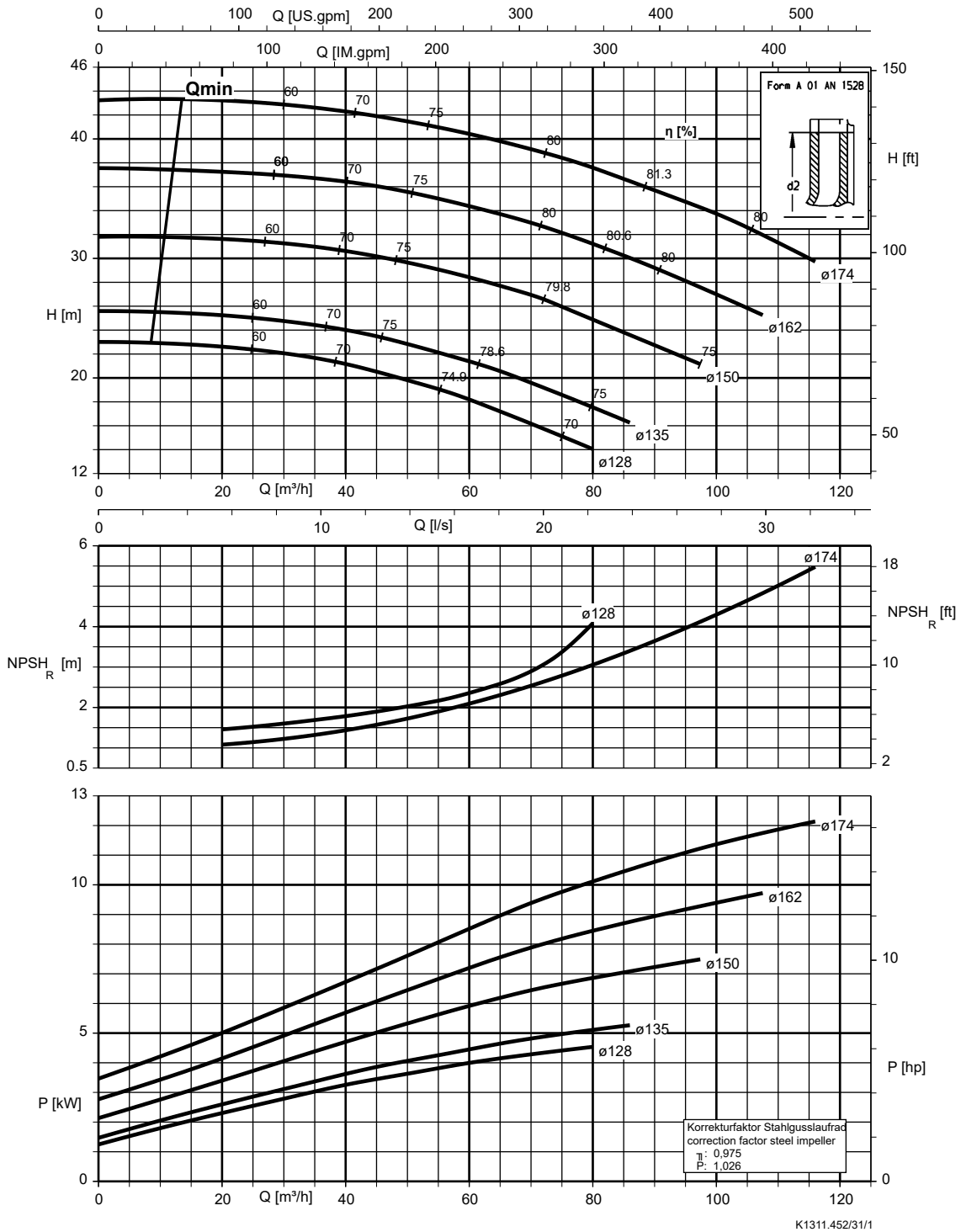

Vlet 065-050-200, n = 2900 rpm

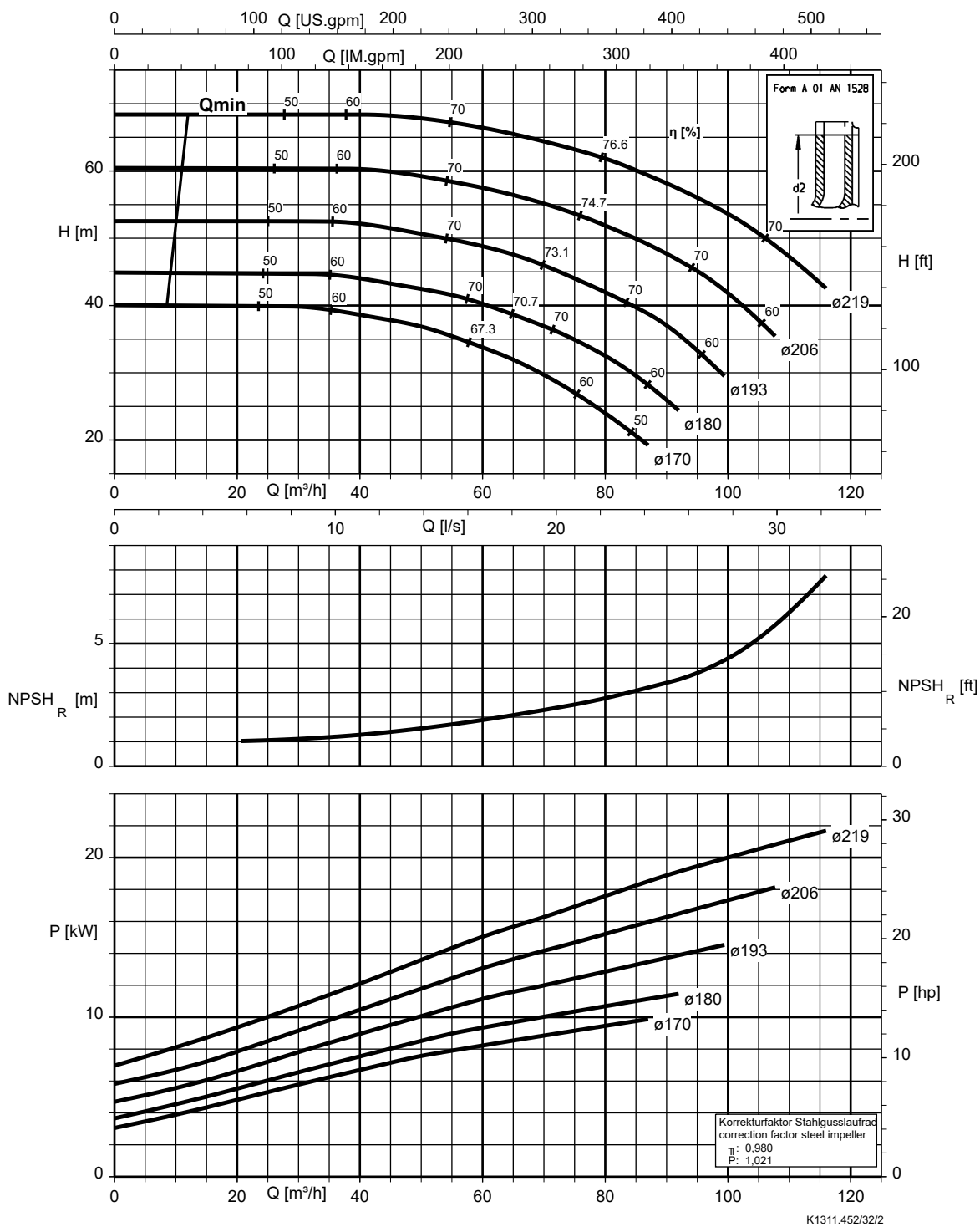

Vlet 065-050-250, n = 2900 rpm

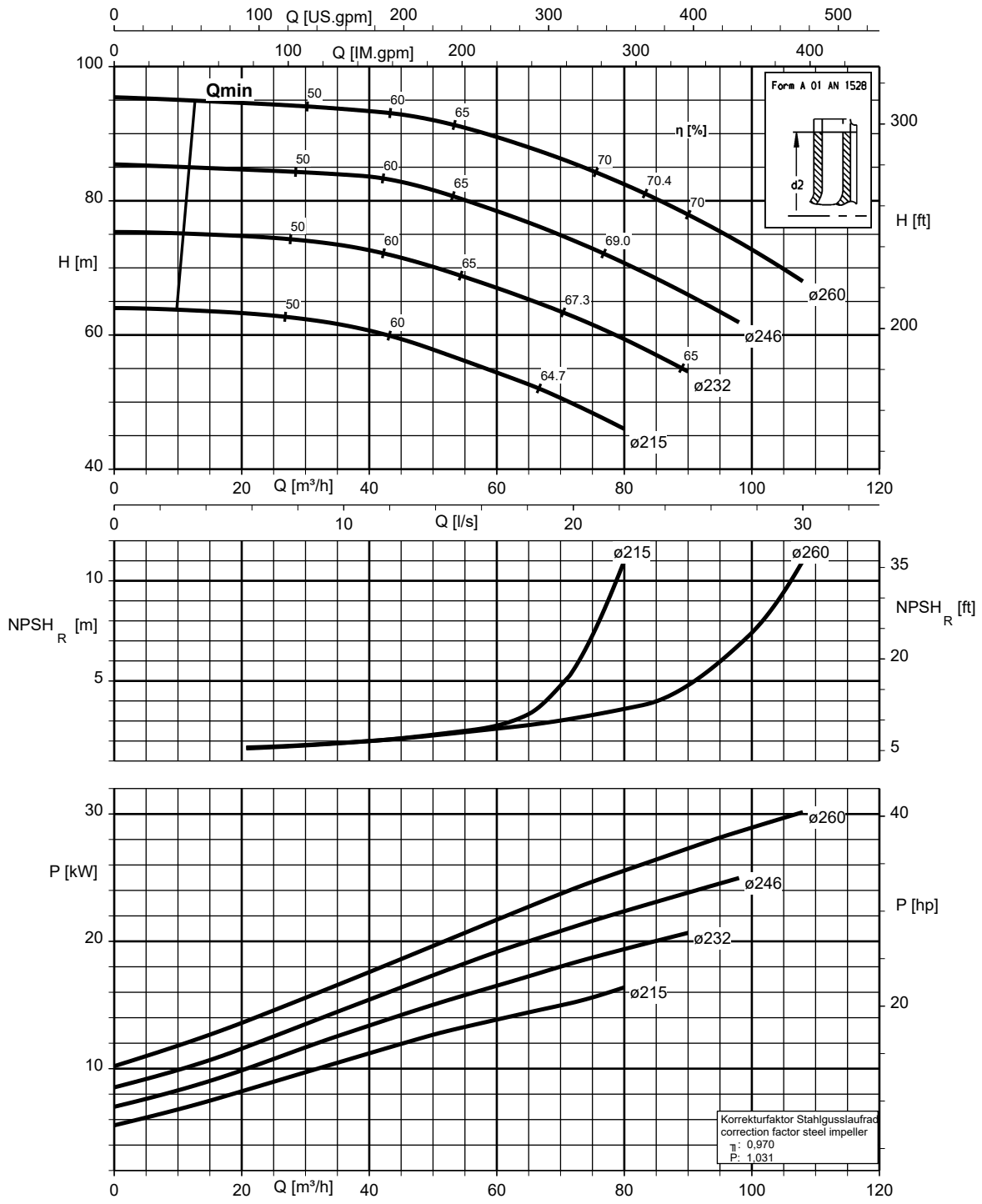

Vlet 065-050-315, n = 2900 rpm

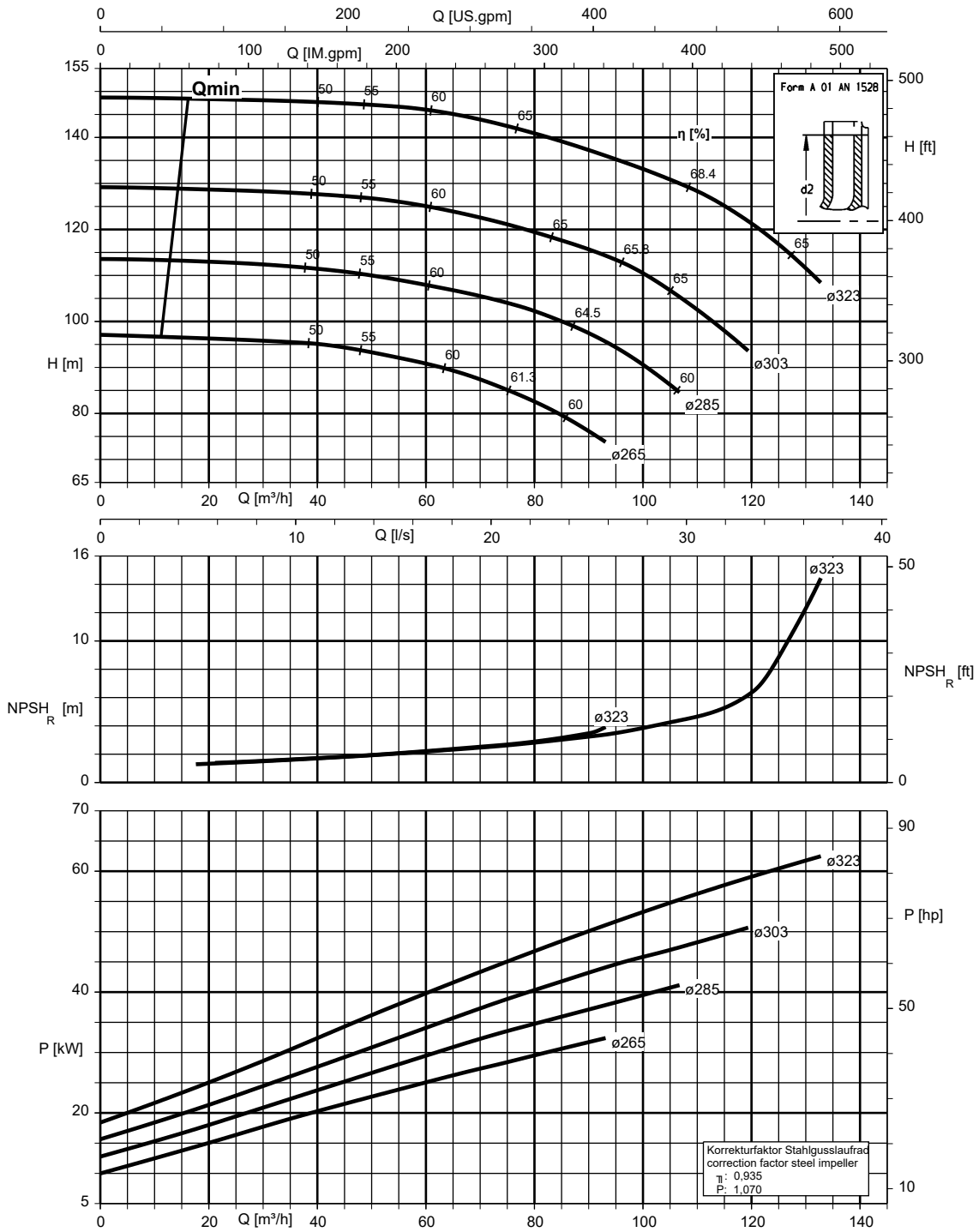

K1311.452/34/2

Vlet 080-065-125, n = 2900 rpm

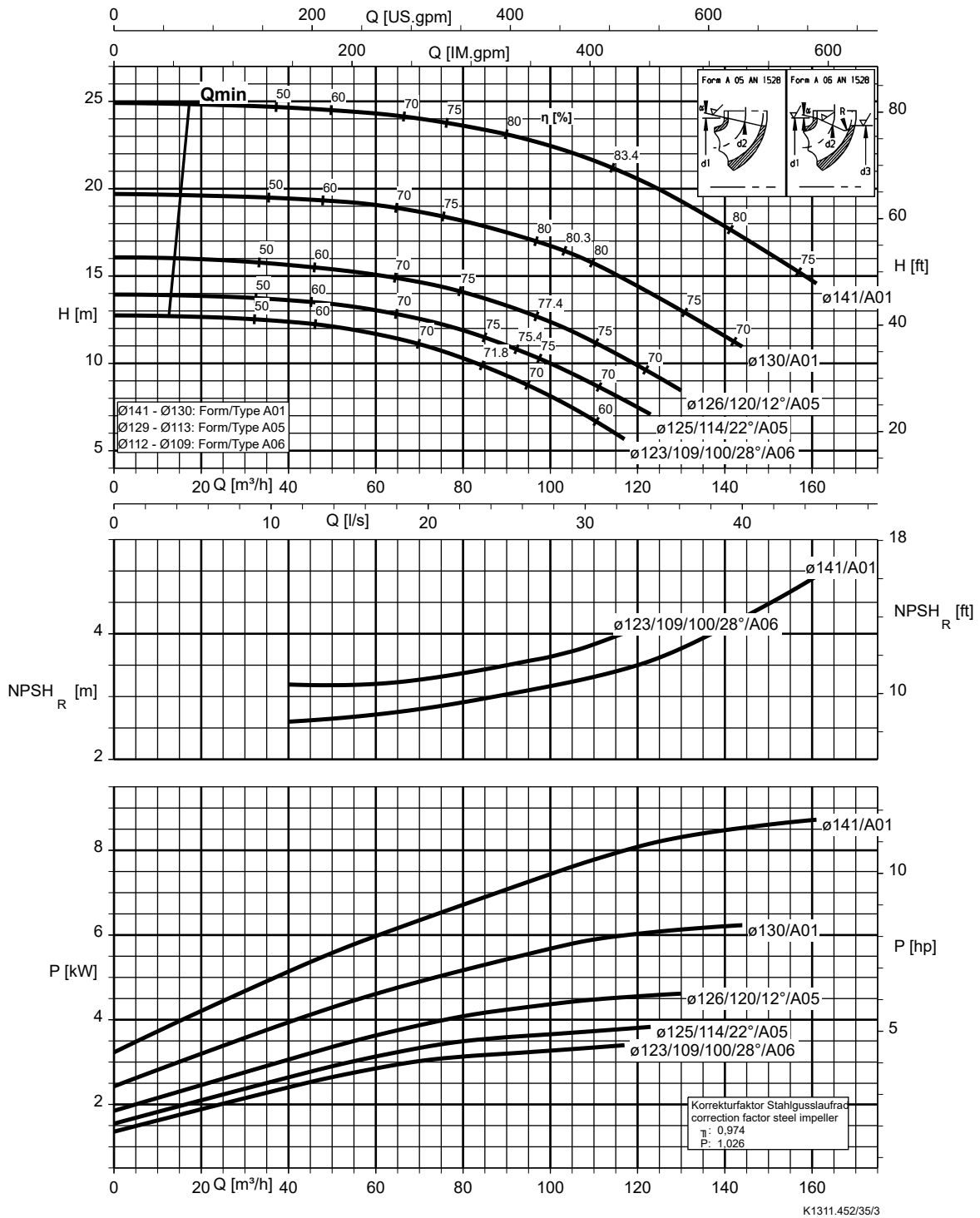

Vlet 080-065-160, n = 2900 rpm

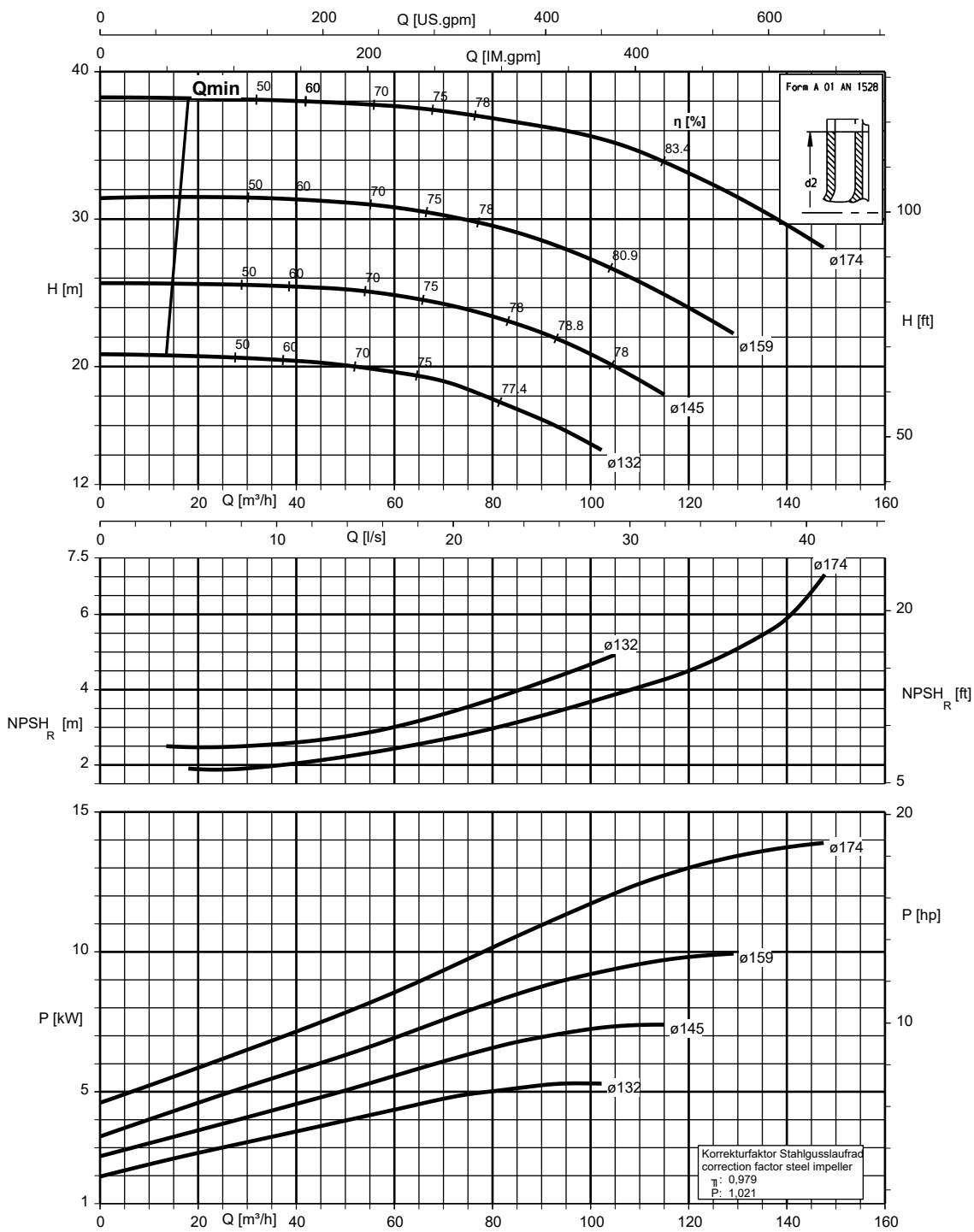

Vlet 080-065-200, n = 2900 rpm

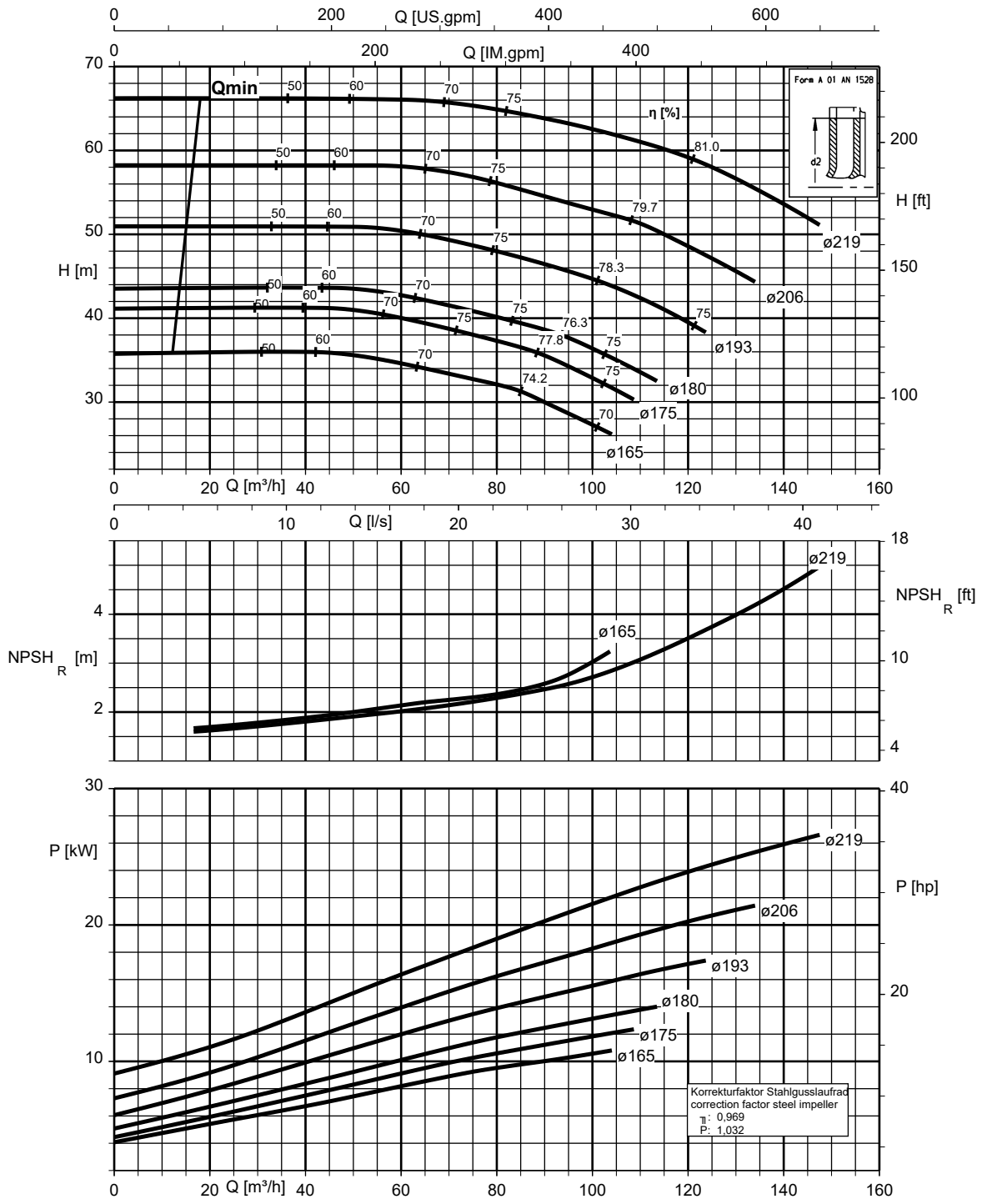

Vlet 080-065-250, n = 2900 rpm

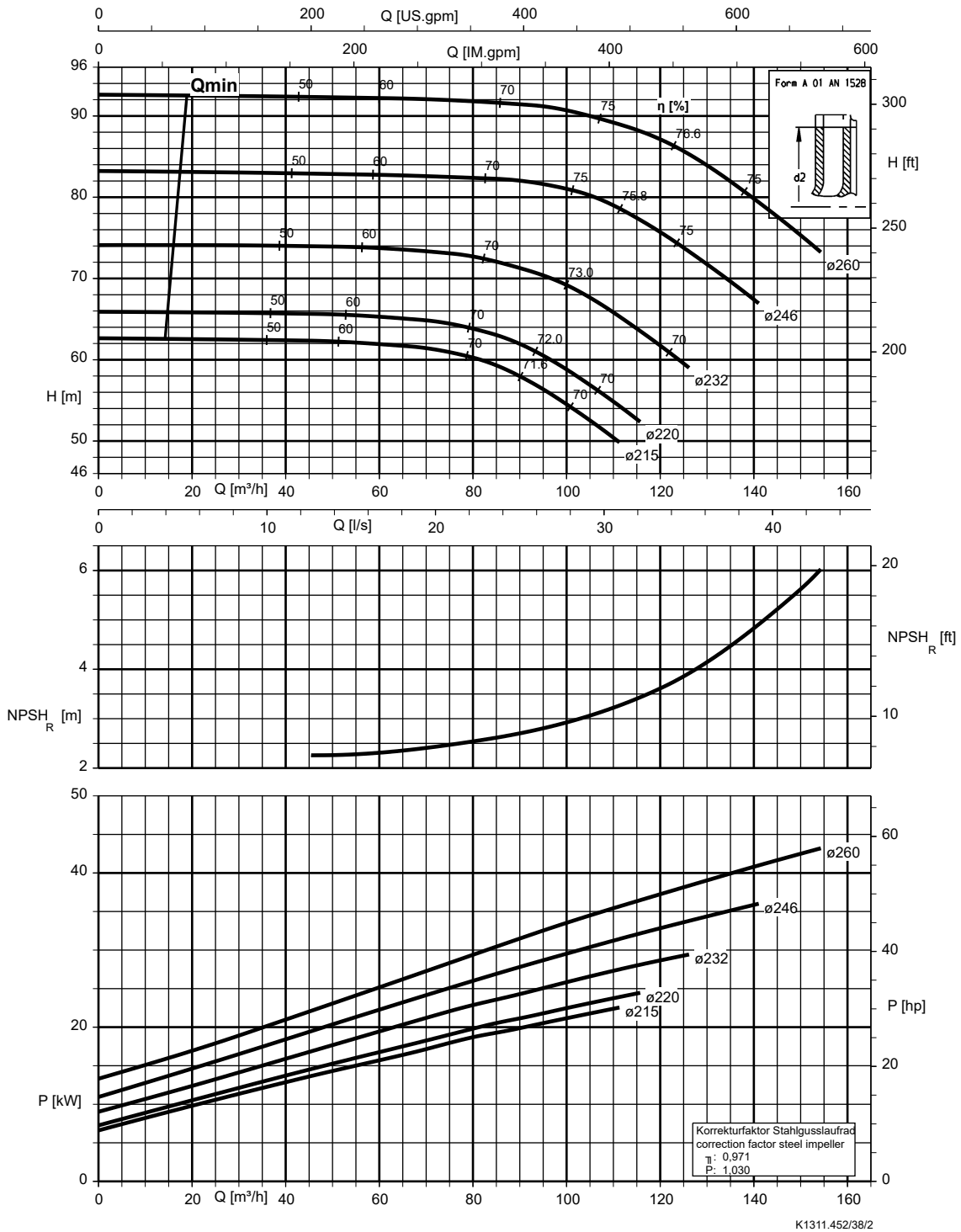

Vlet 080-065-315, n = 2900 rpm

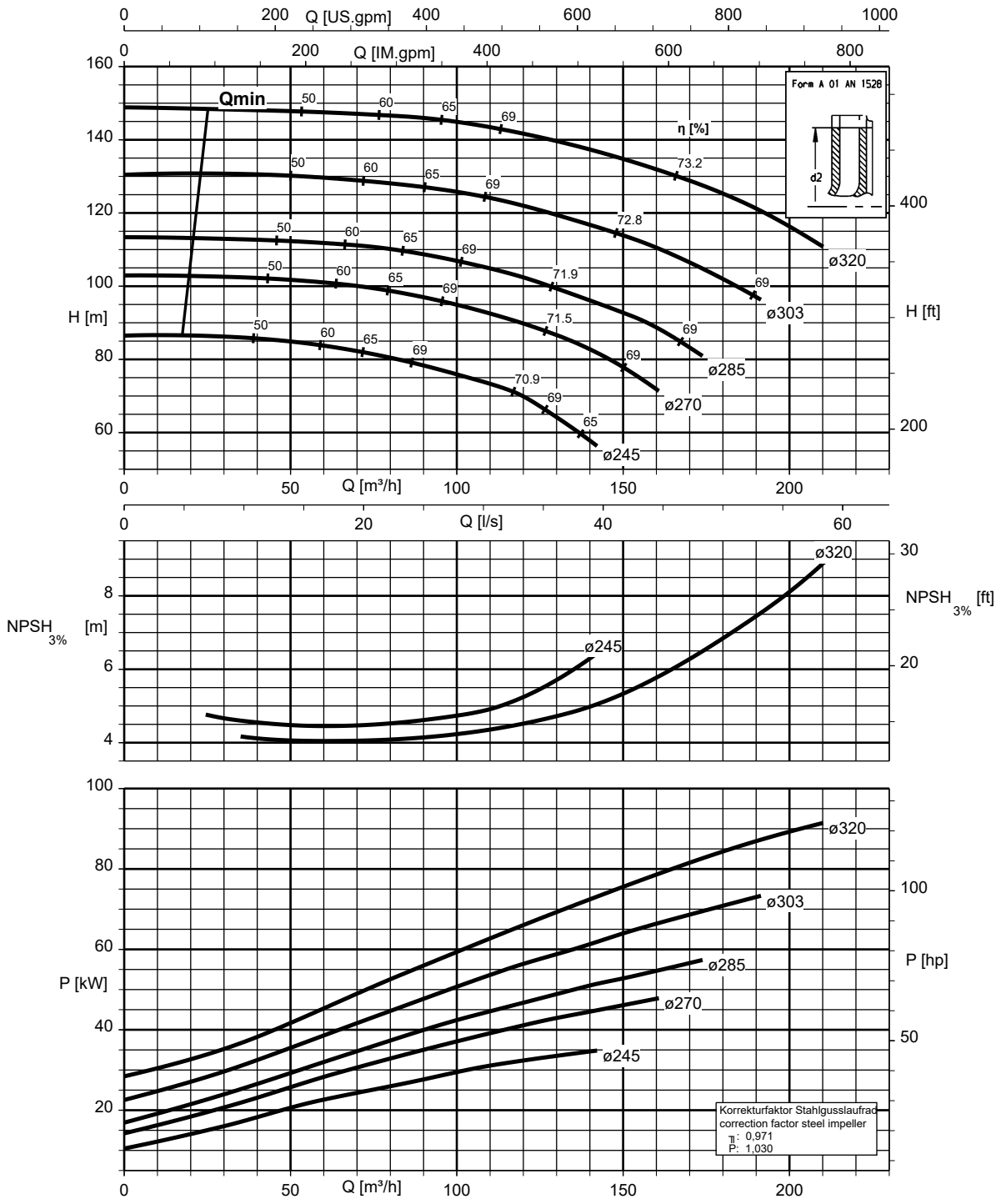

K1311.452/39/4

Vlet 100-080-160, n = 2900 rpm

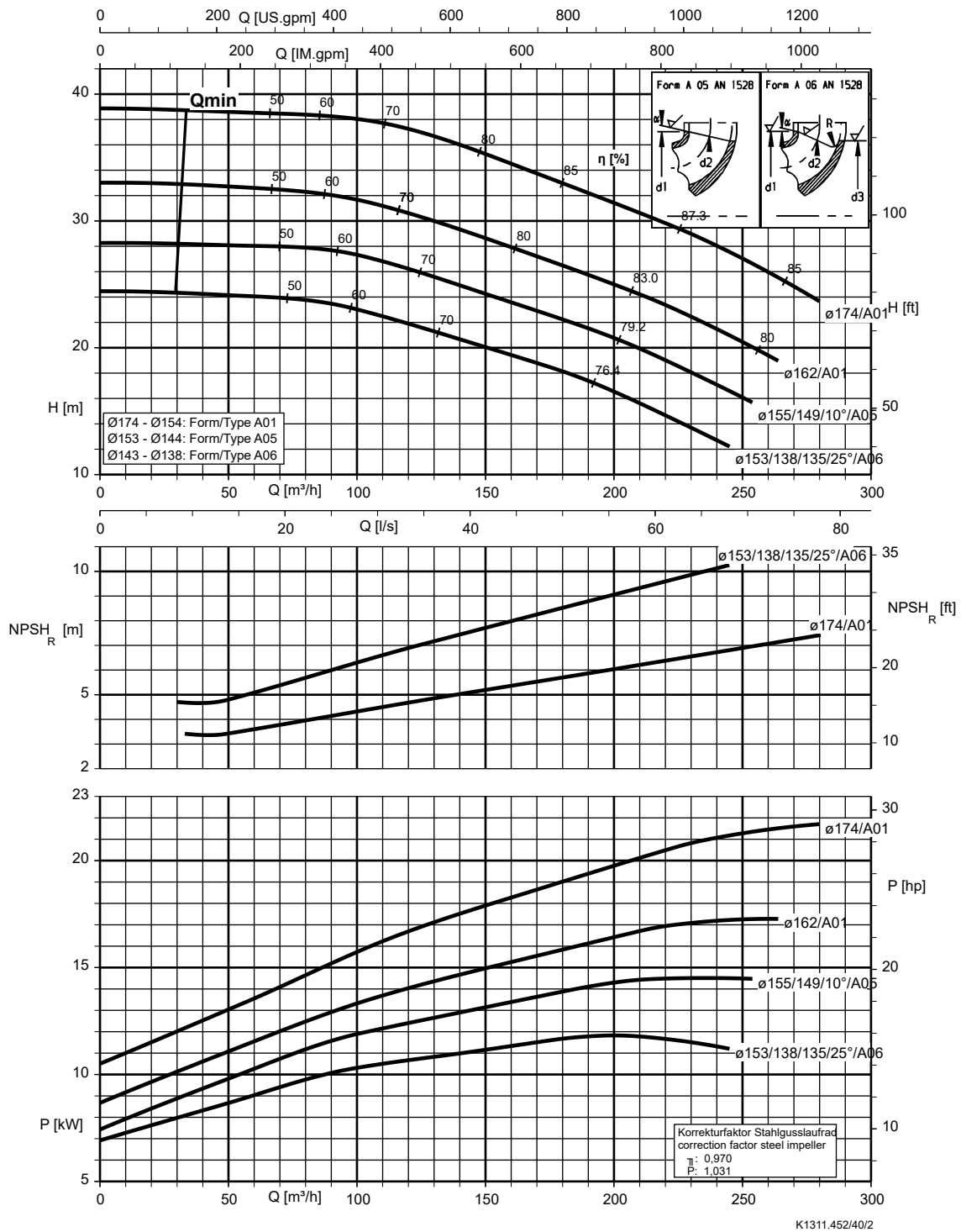

K1311.452/40/2

Vlet 100-080-200, n = 2900 rpm

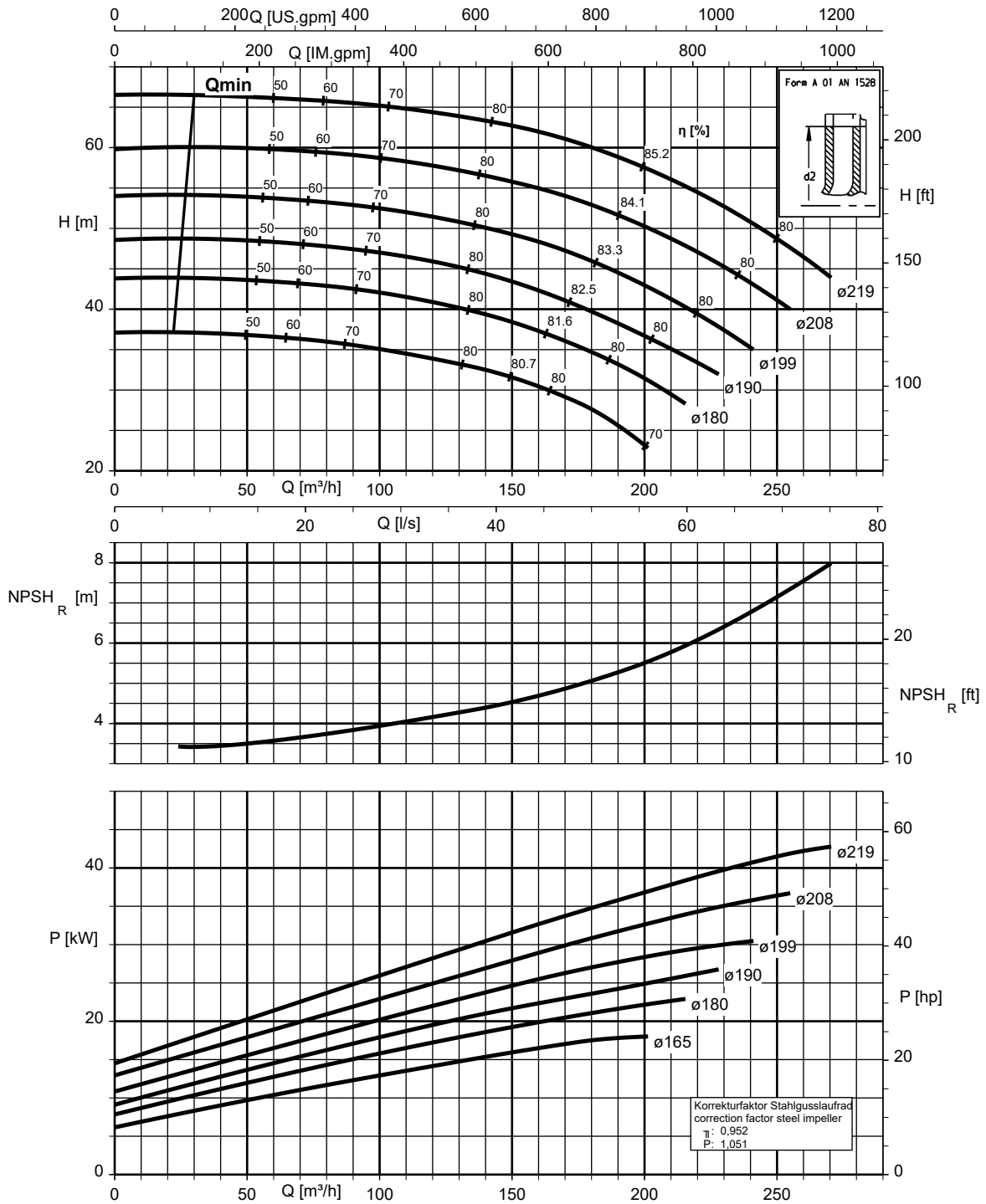

K1311.452/41/3

Vlet 100-080-250, n = 2900 rpm

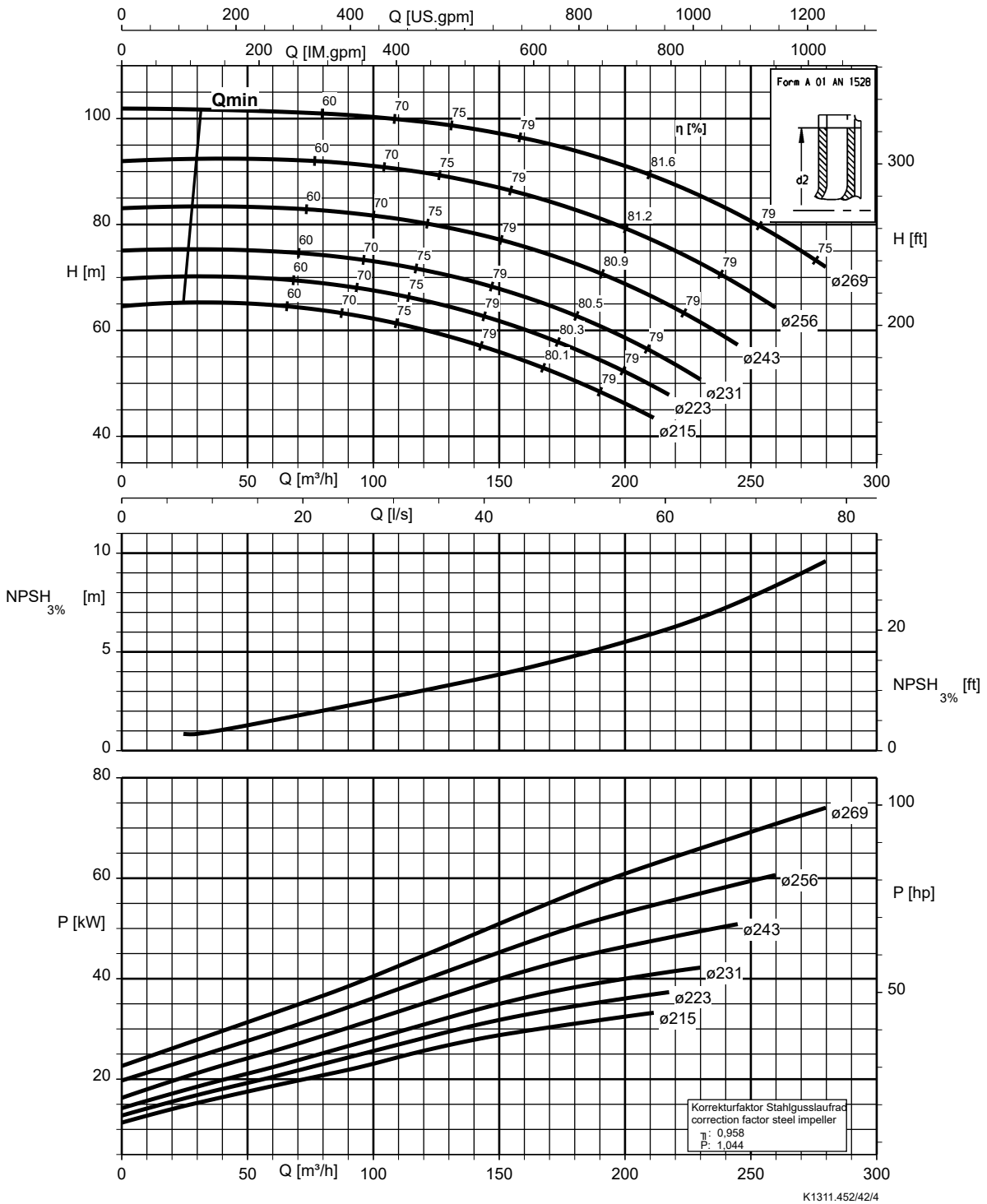

Vlet 100-080-315, n = 2900 rpm

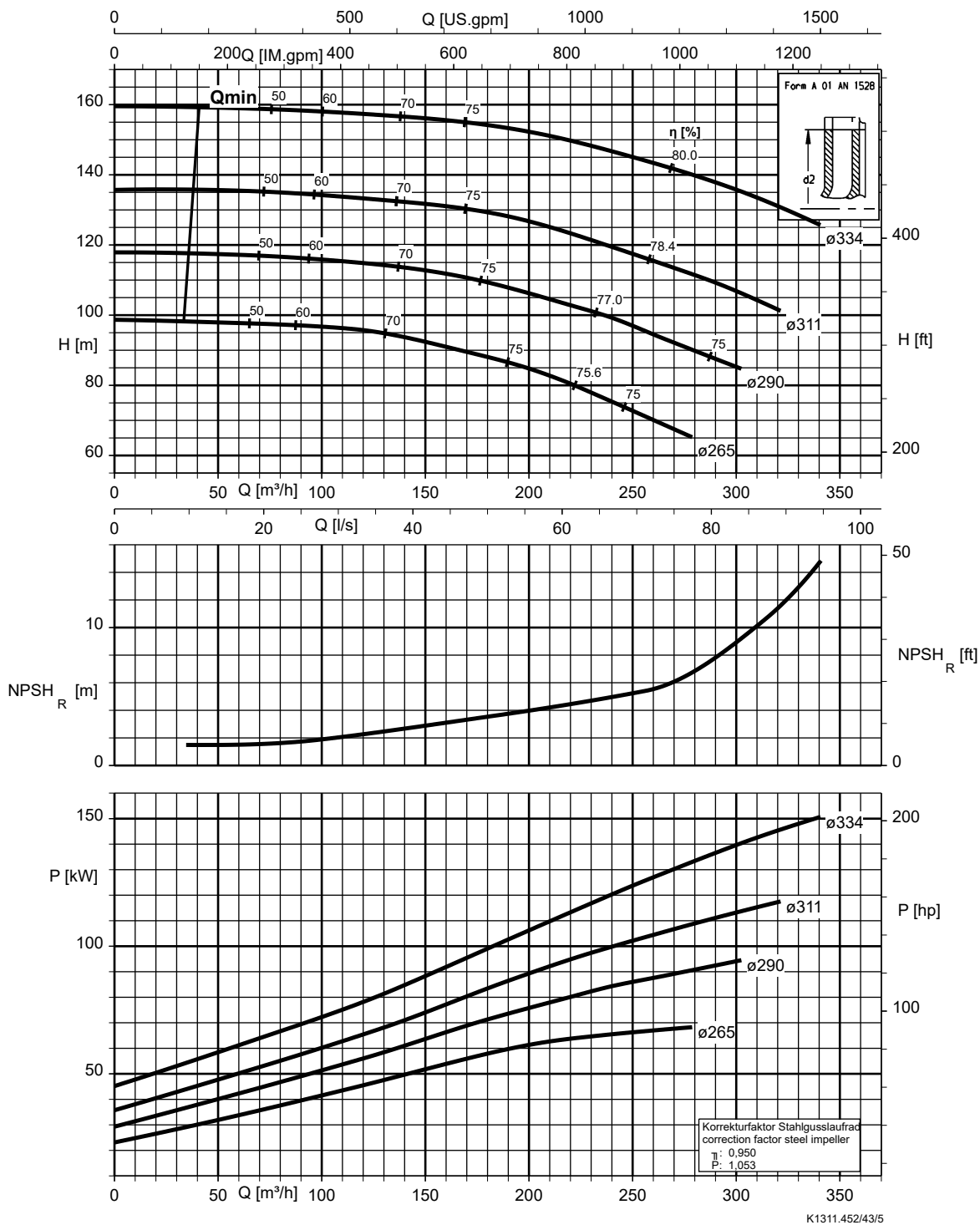

Vlet 125-100-160, n = 2900 rpm

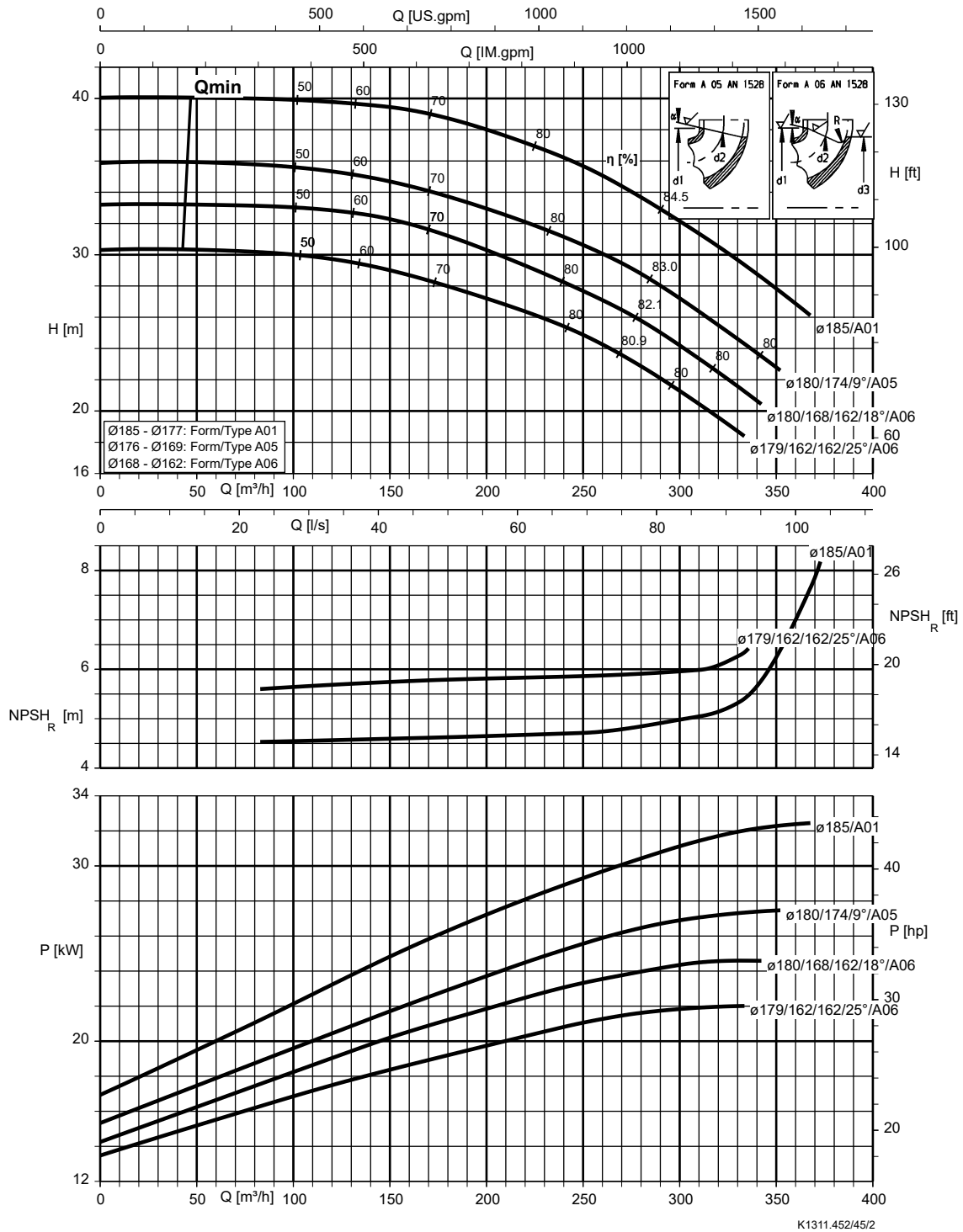

Vlet 125-100-200, n = 2900 rpm

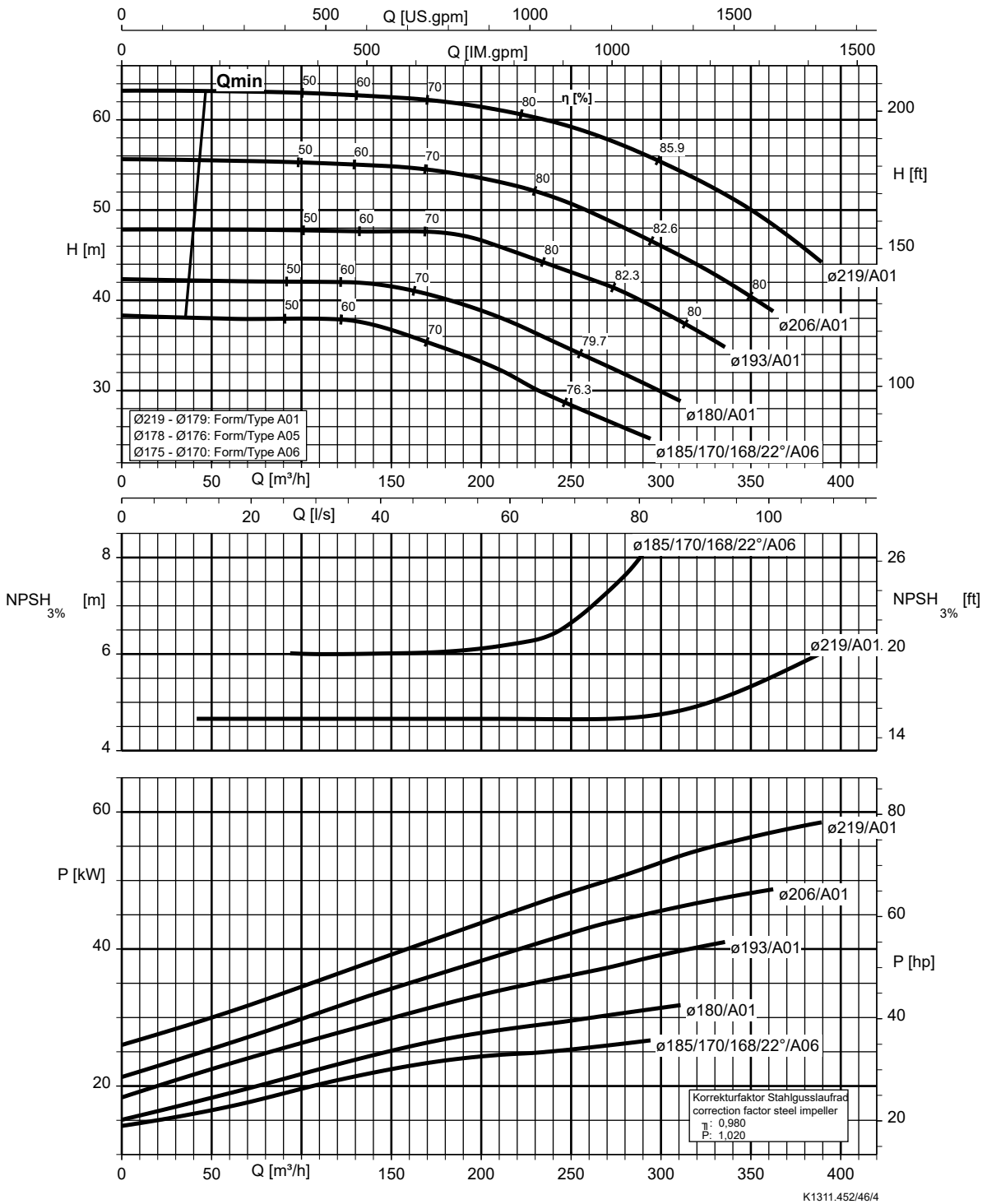

K1311.452/46/4

Vlet 125-100-250, n = 2900 rpm

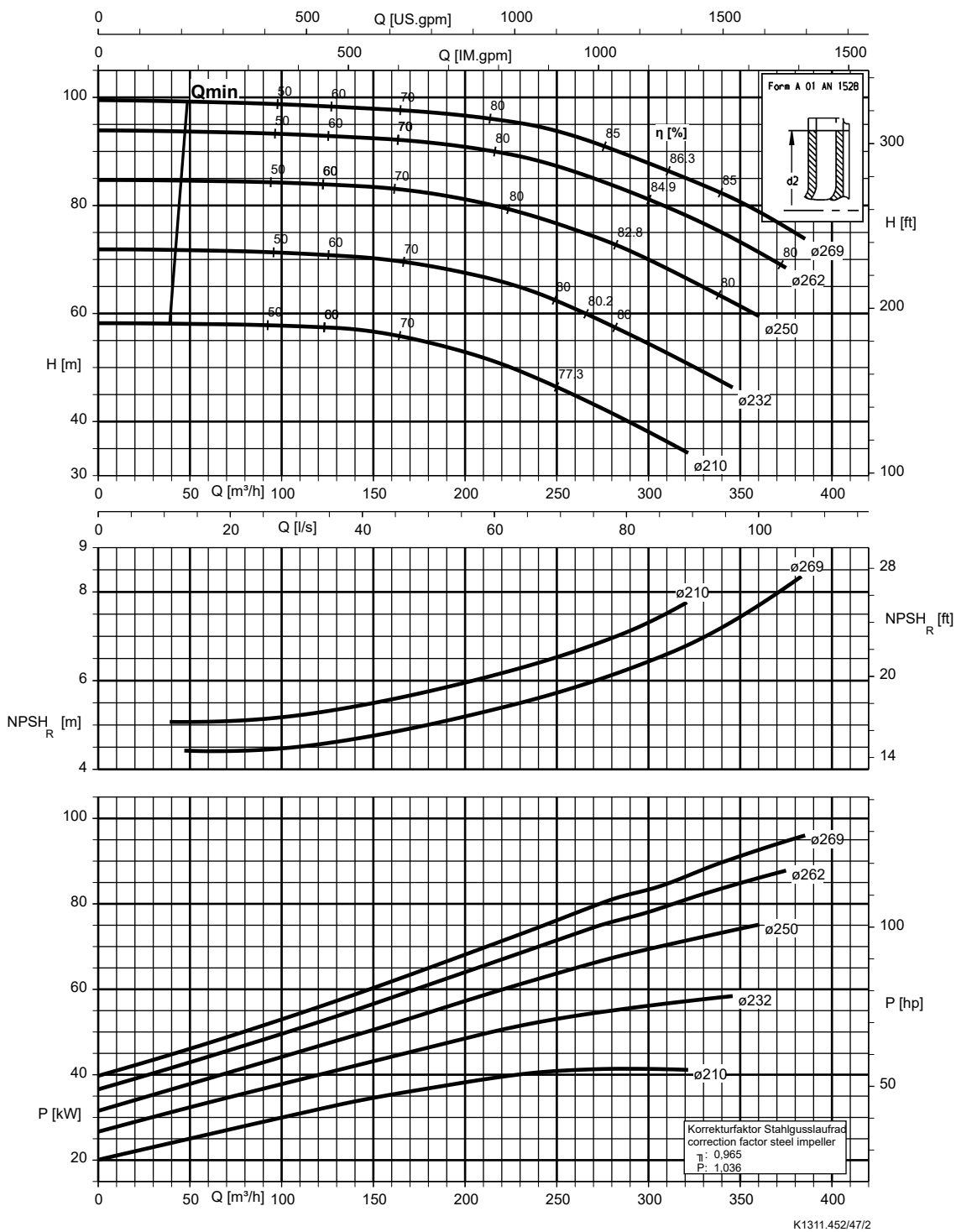

Vlet 125-100-315, n = 2900 rpm

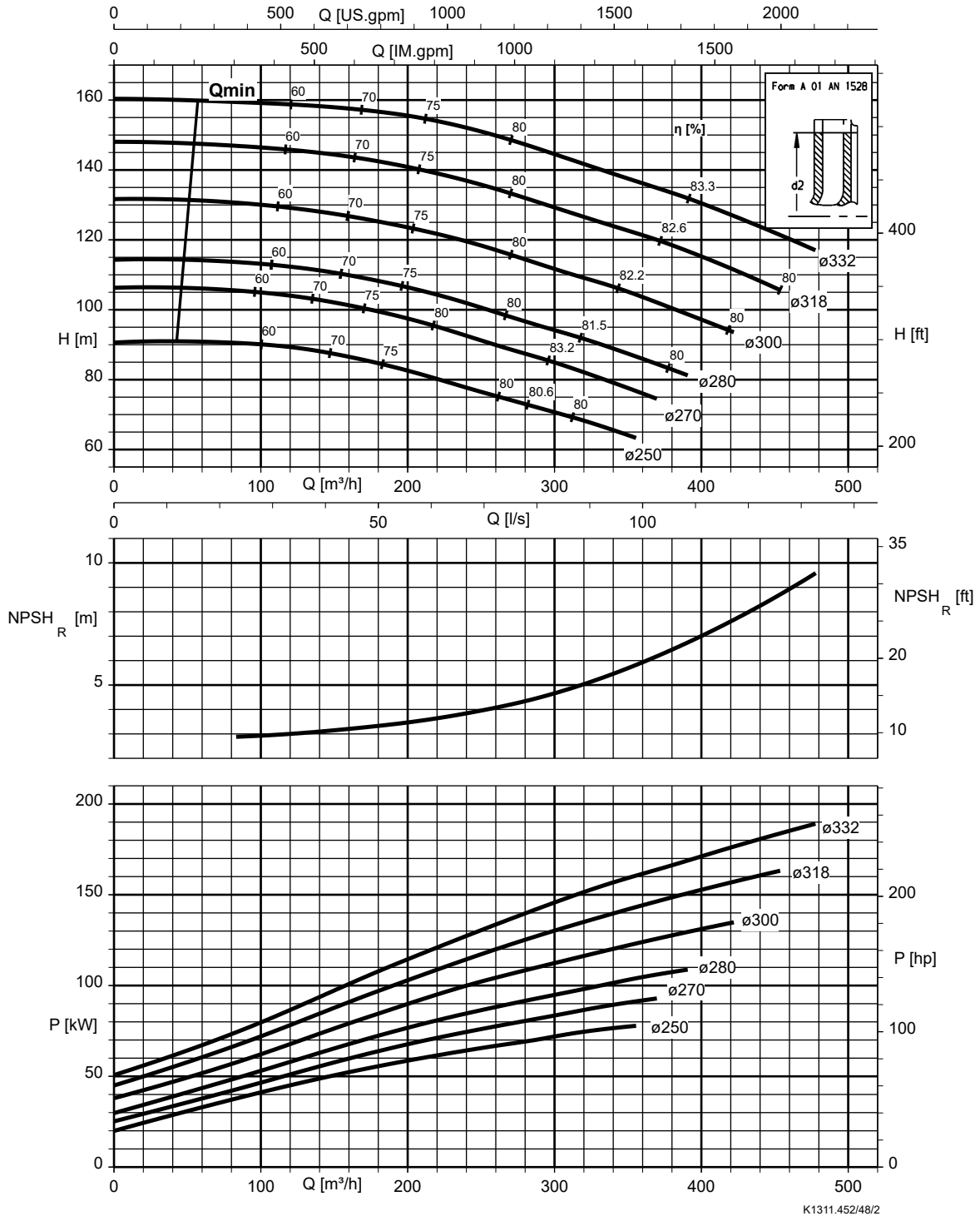

Vlet 150-125-200, n = 2900 rpm

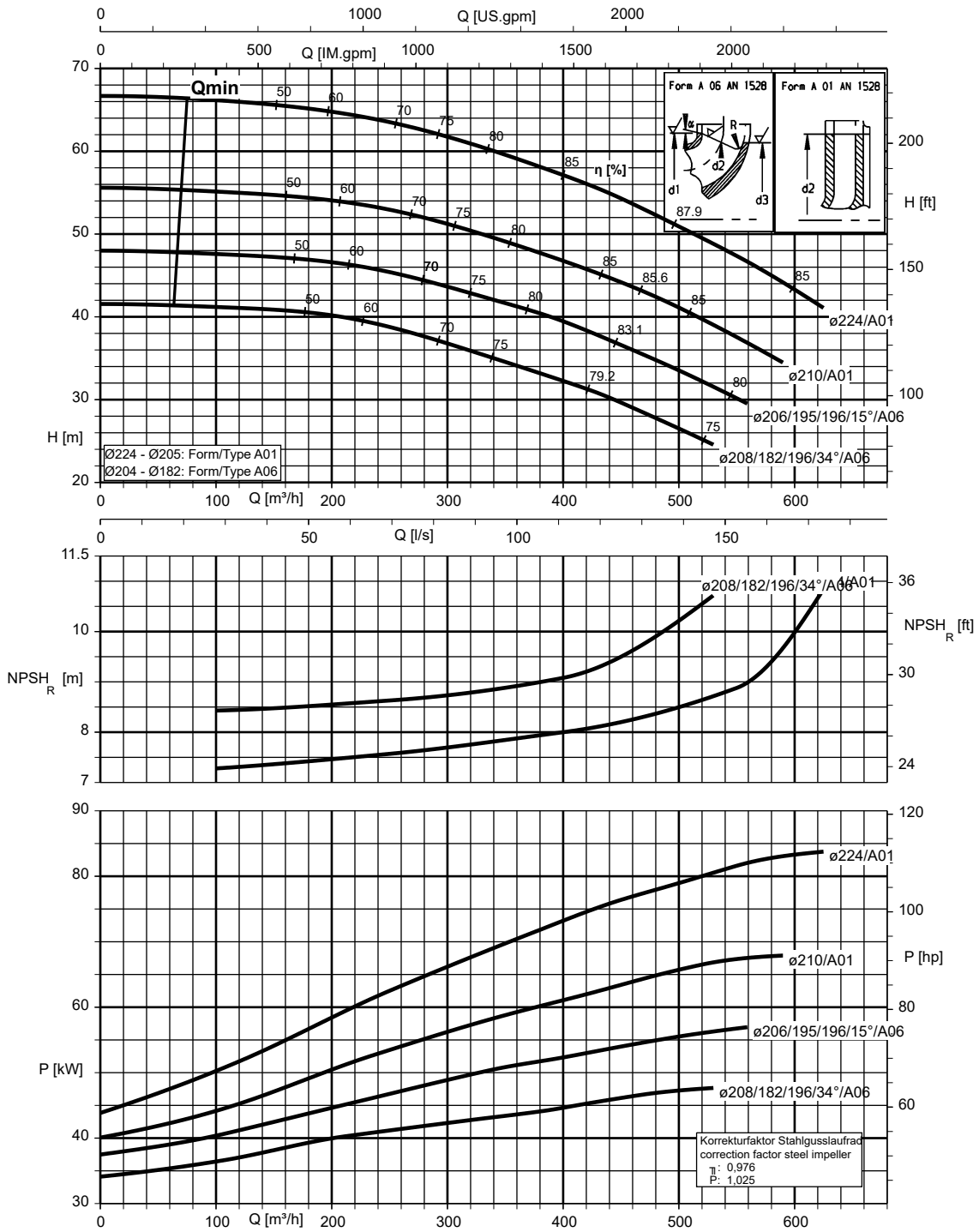

K1311.452/50/2

n = 1450 rpm

Vlet 040-025-160, n = 1450 rpm

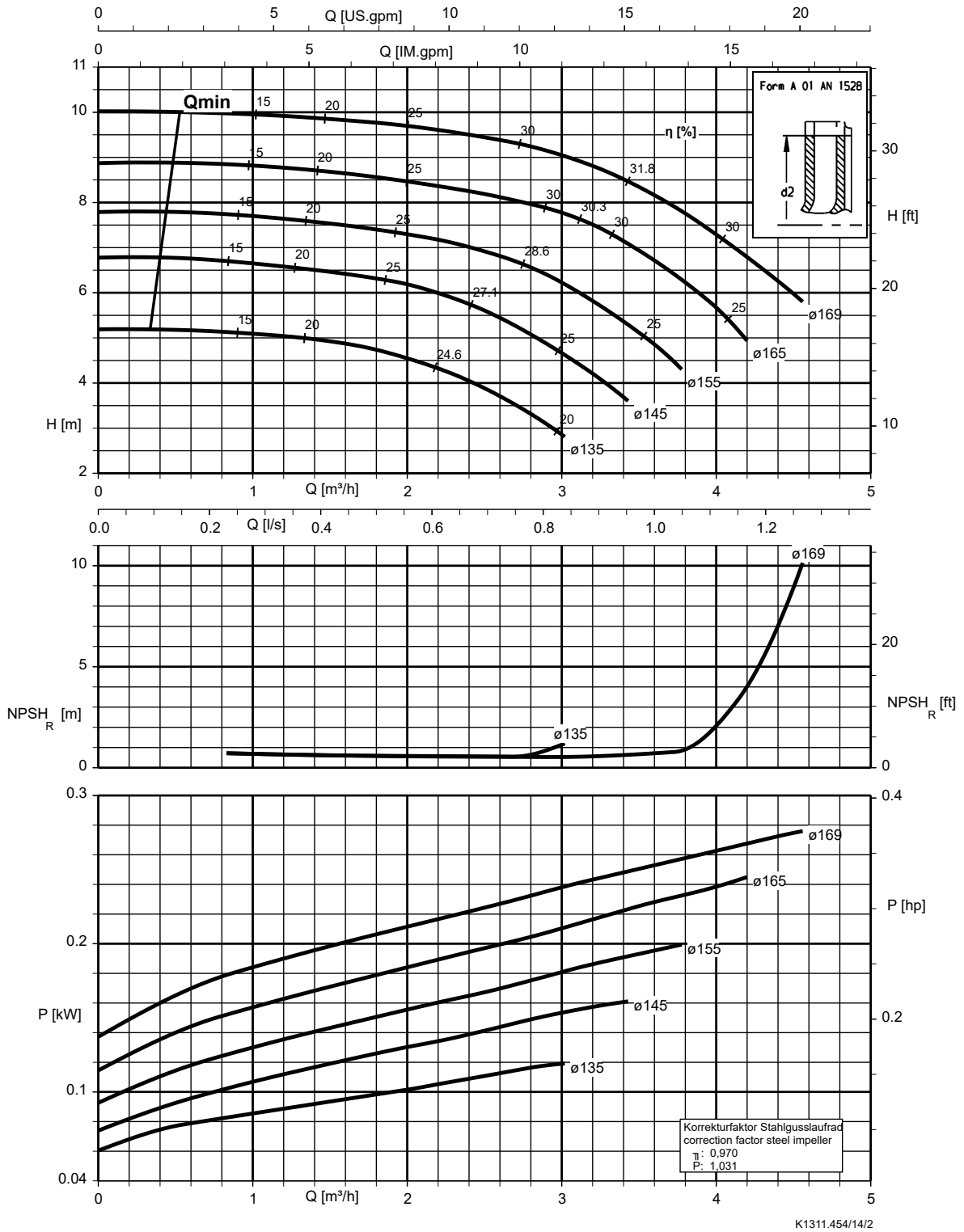

Vlet 040-025-200, n = 1450 rpm

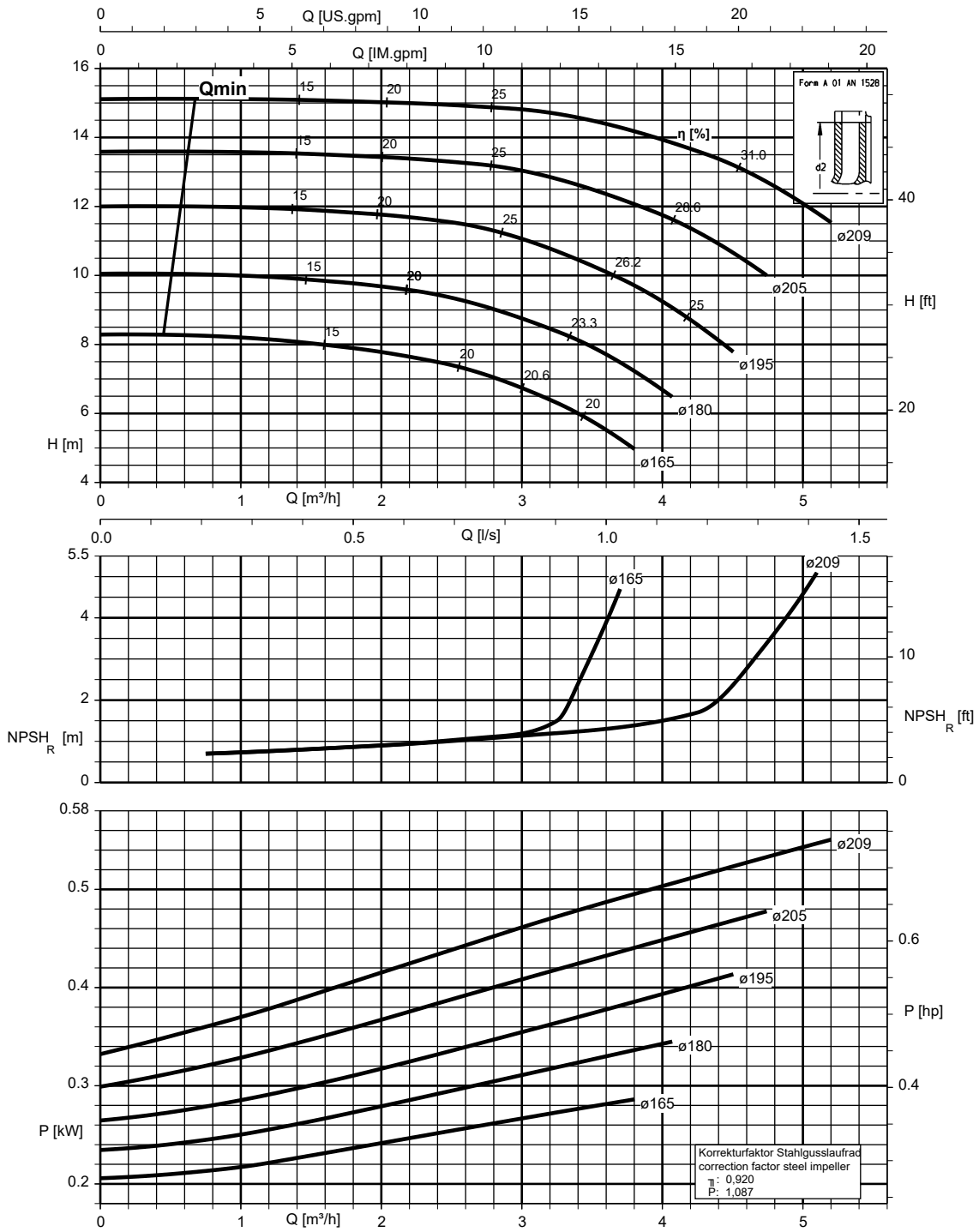

K1311.454/15/2

Vlet 050-032-125.1, n = 1450 rpm

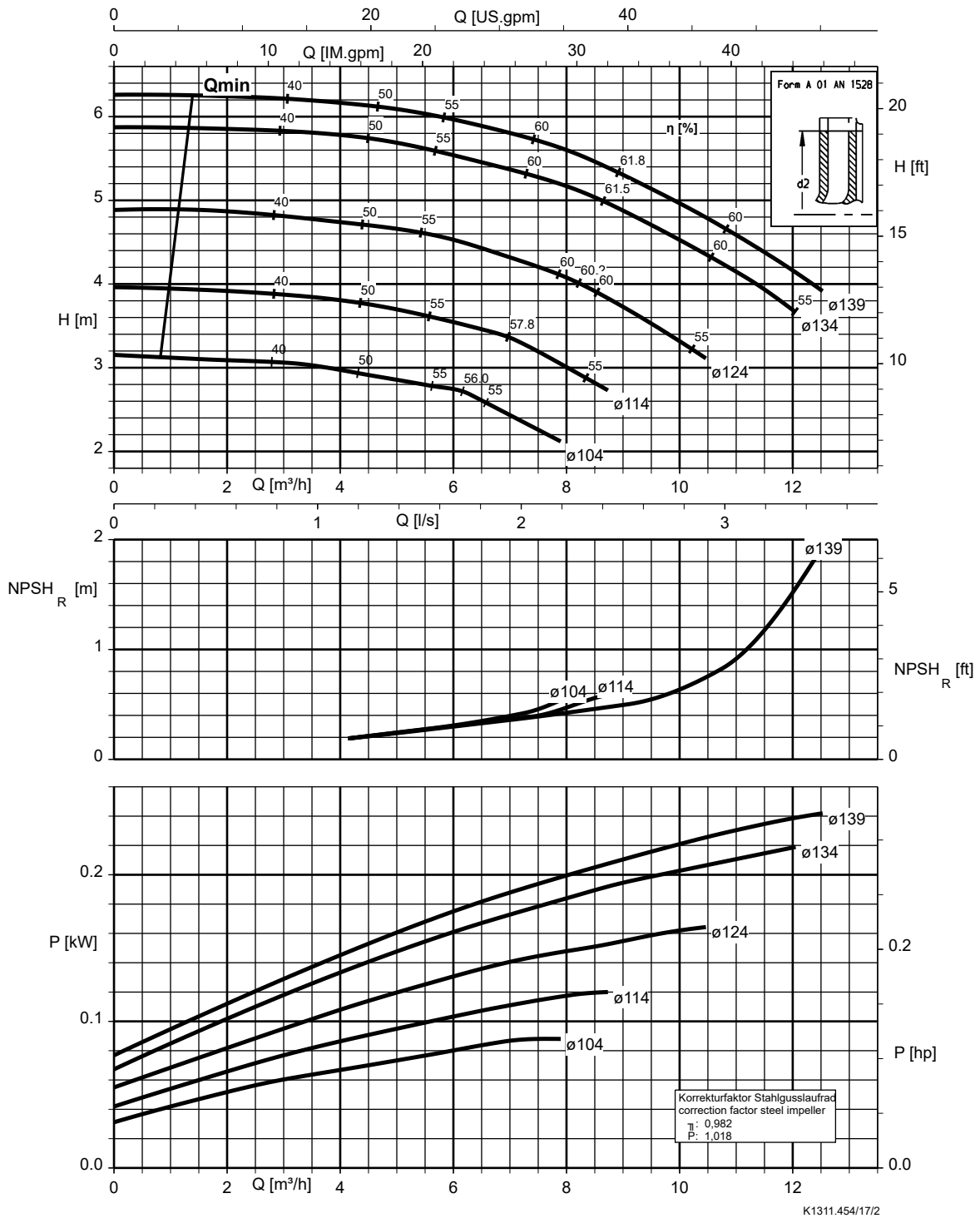

Vlet 050-032-160.1, n = 1450 rpm

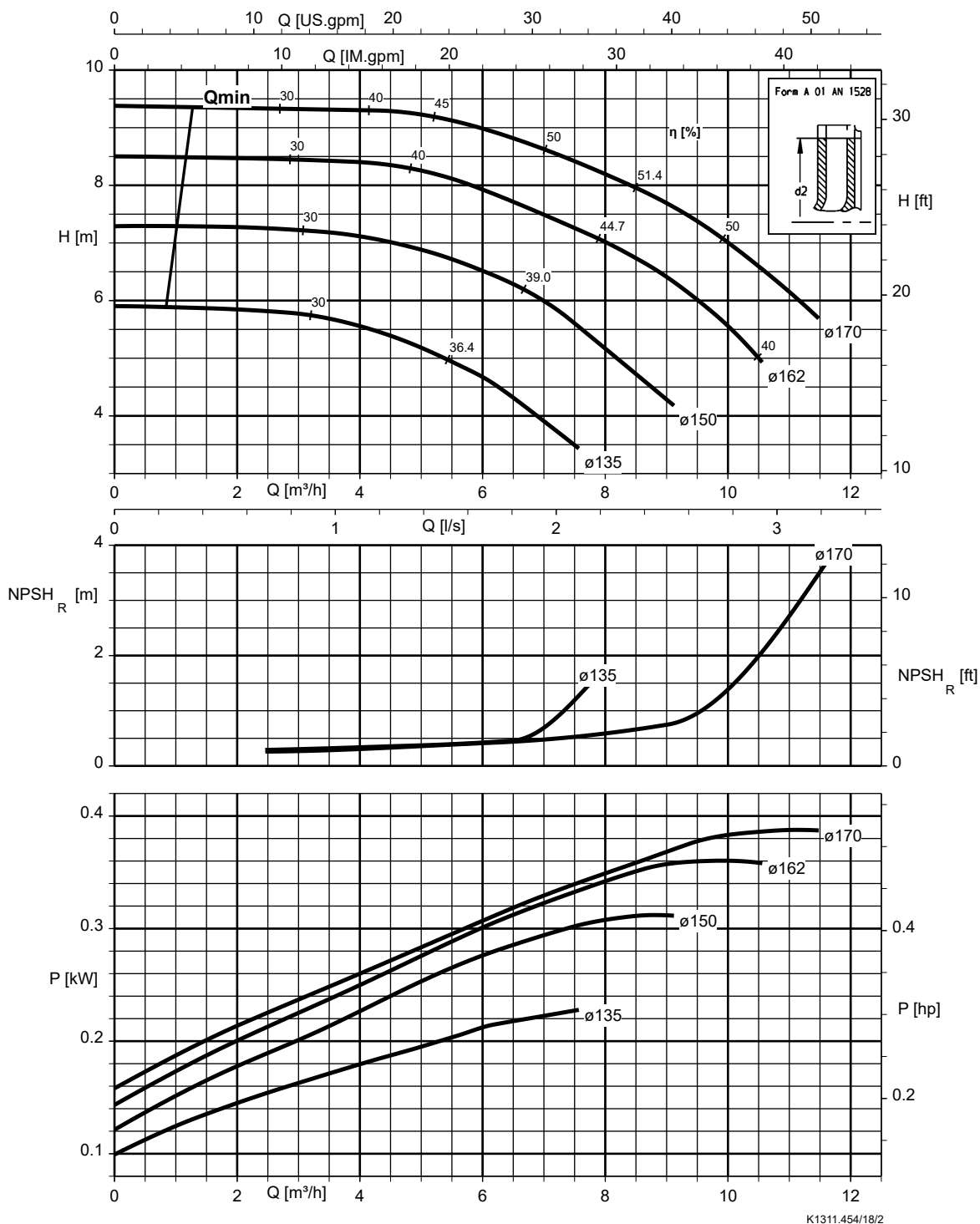

Vlet 050-032-200.1, n = 1450 rpm

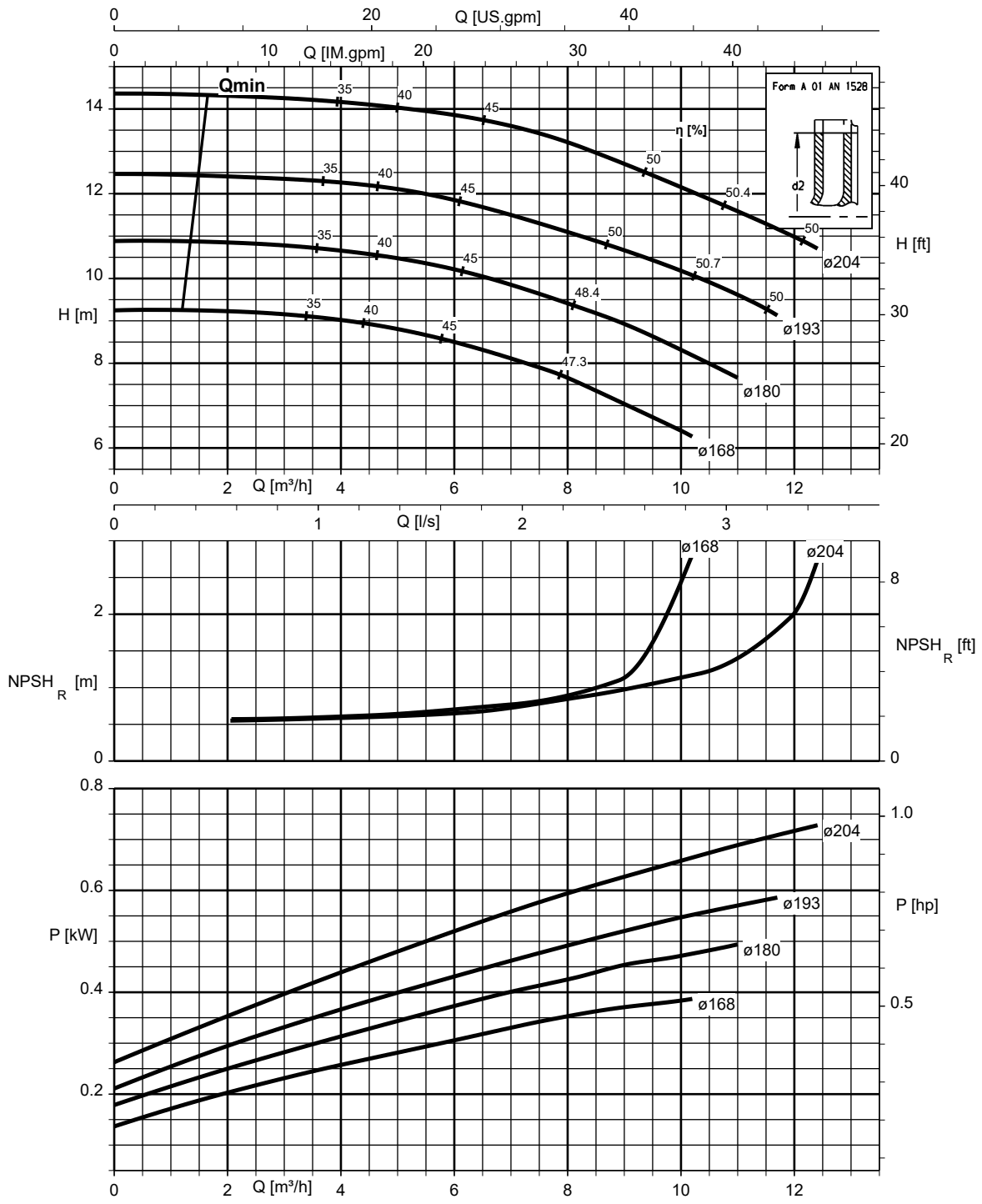

Vlet 050-032-250.1, n = 1450 rpm

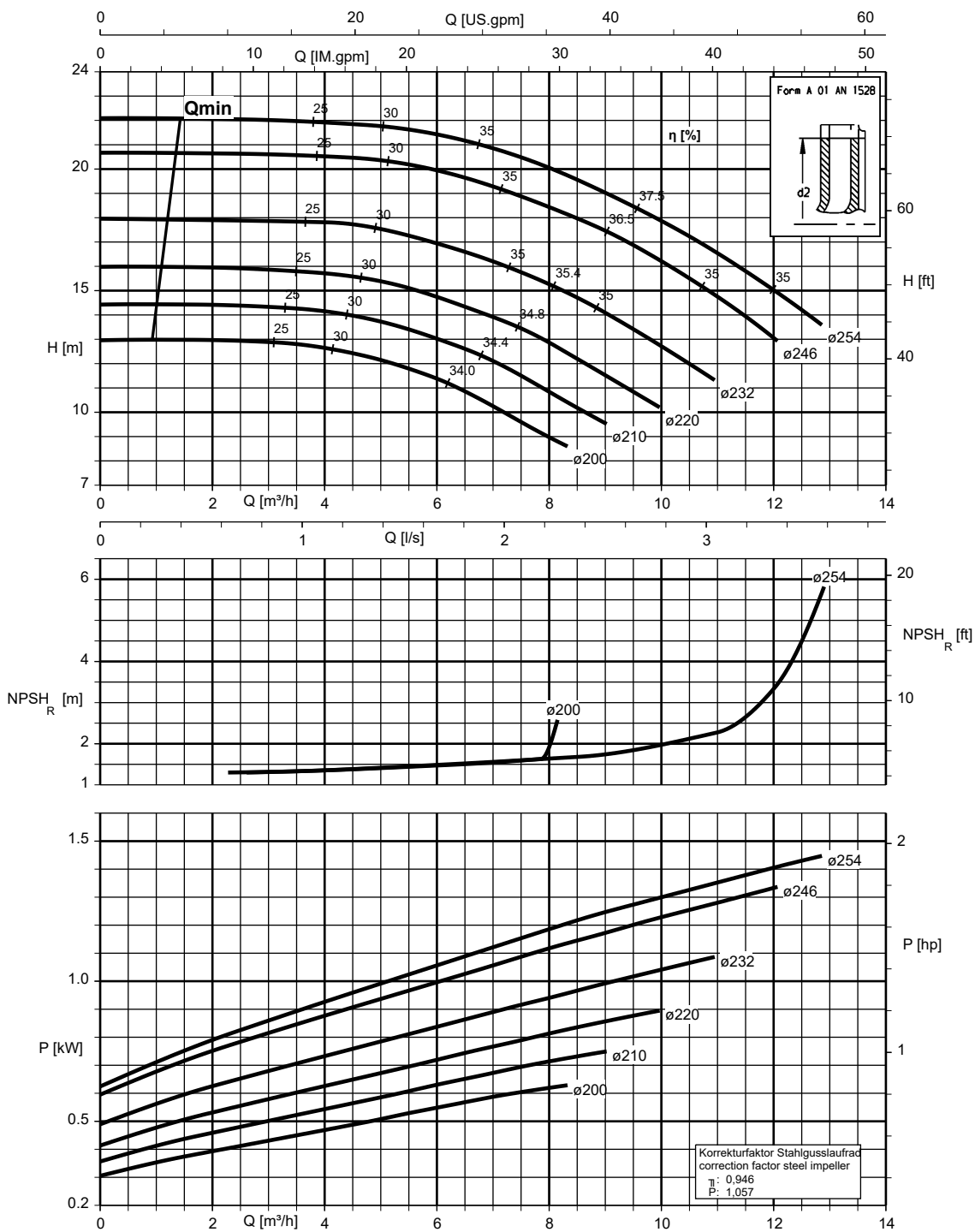

K1311.454/20/2

Vlet 050-032-125, n = 1450 rpm

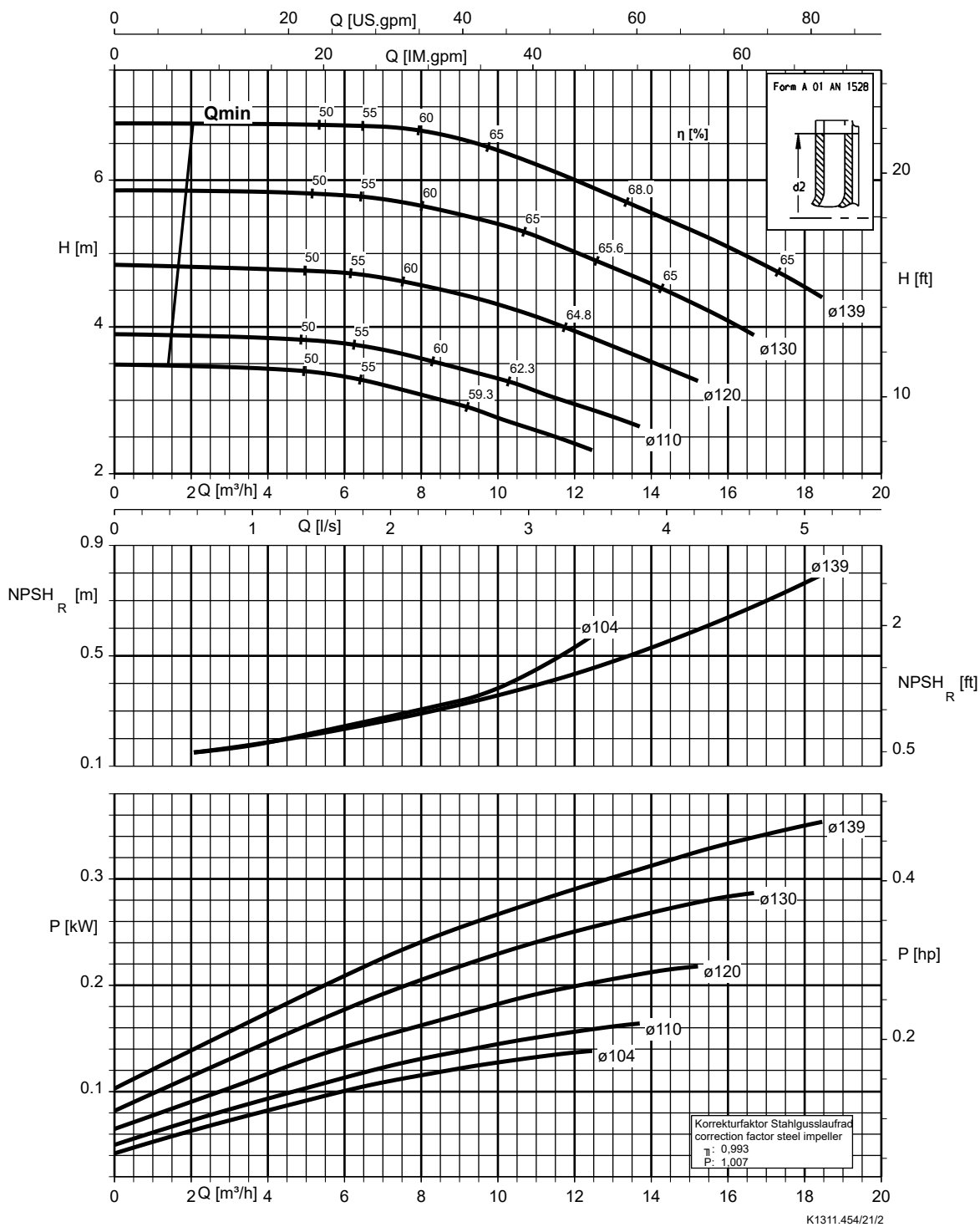

Vlet 050-032-160, n = 1450 rpm

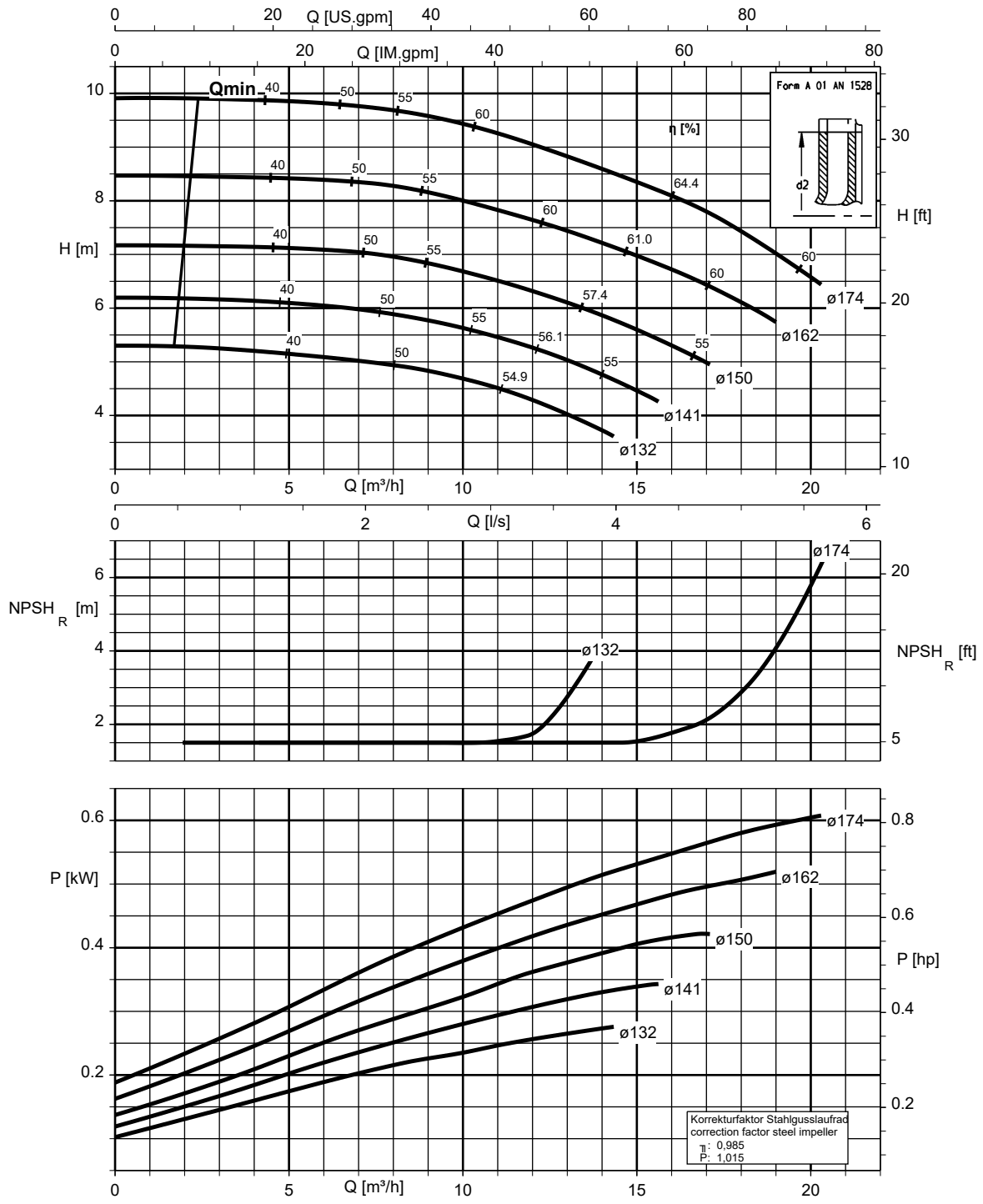

Vlet 050-032-200, n = 1450 rpm

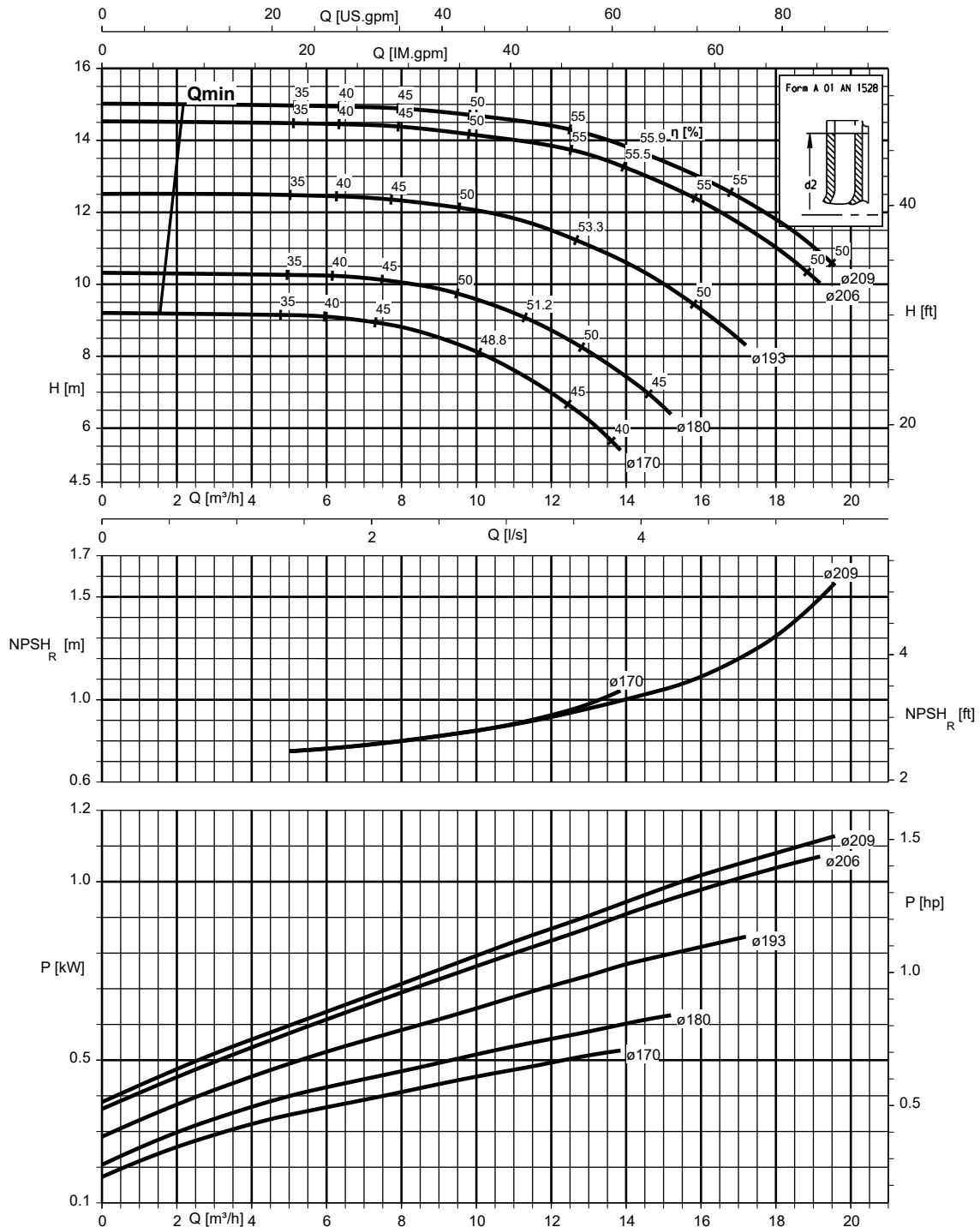

K1311.454/23/1

Vlet 050-032-250, n = 1450 rpm

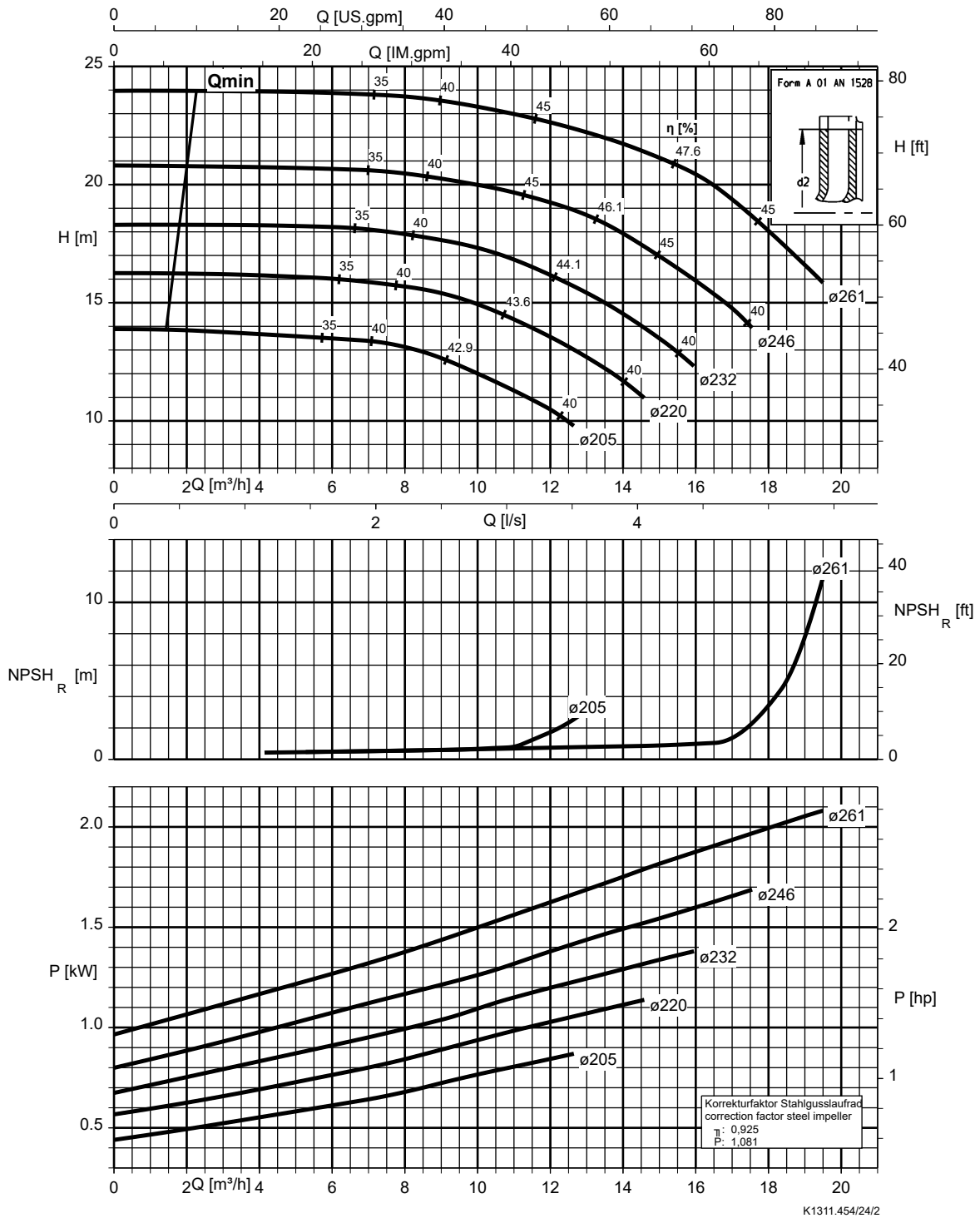

Vlet 065-040-125, n = 1450 rpm

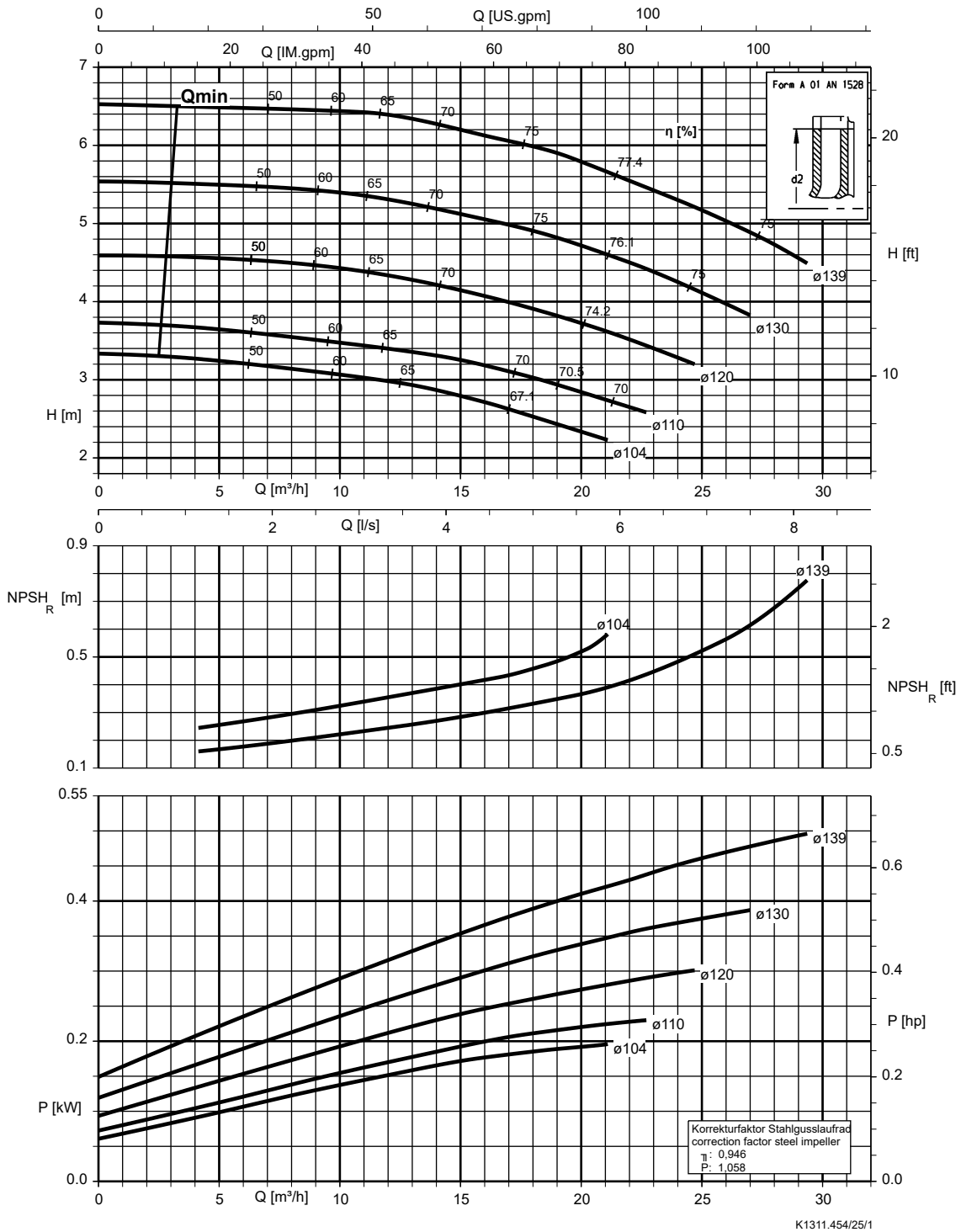

Vlet 065-040-160, n = 1450 rpm

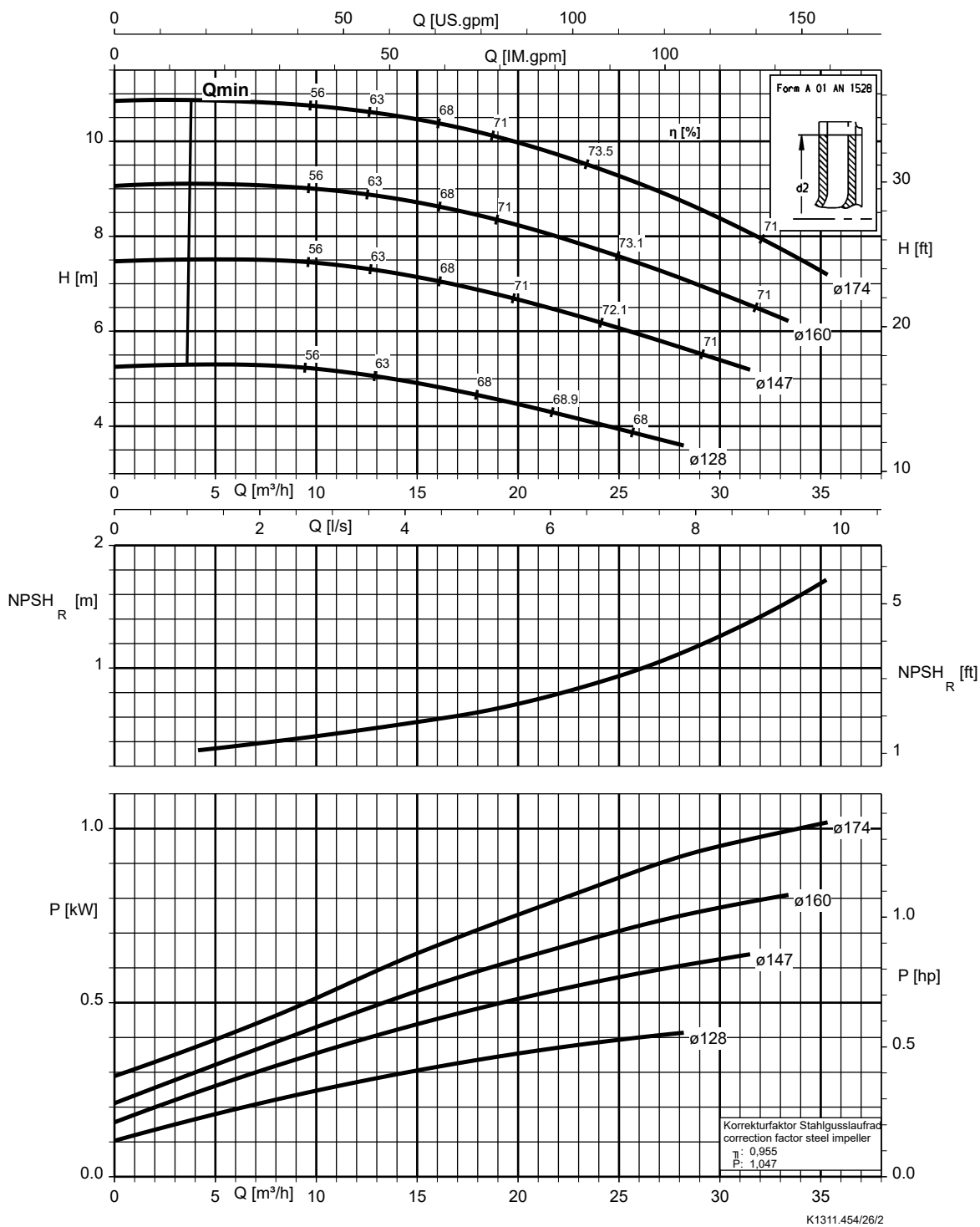

Vlet 065-040-200, n = 1450 rpm

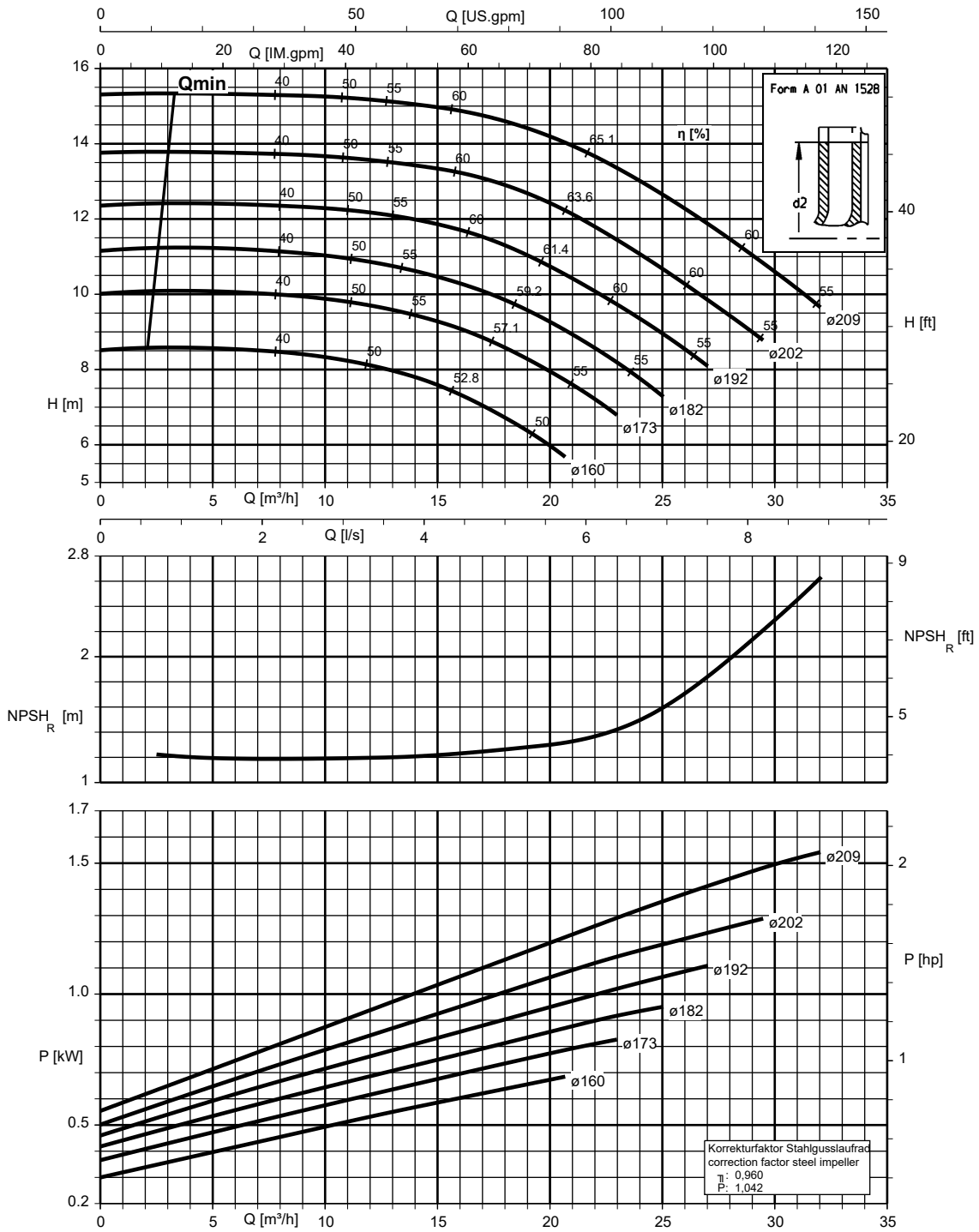

K1311.454/27/1

Vlet 065-040-250, n = 1450 rpm

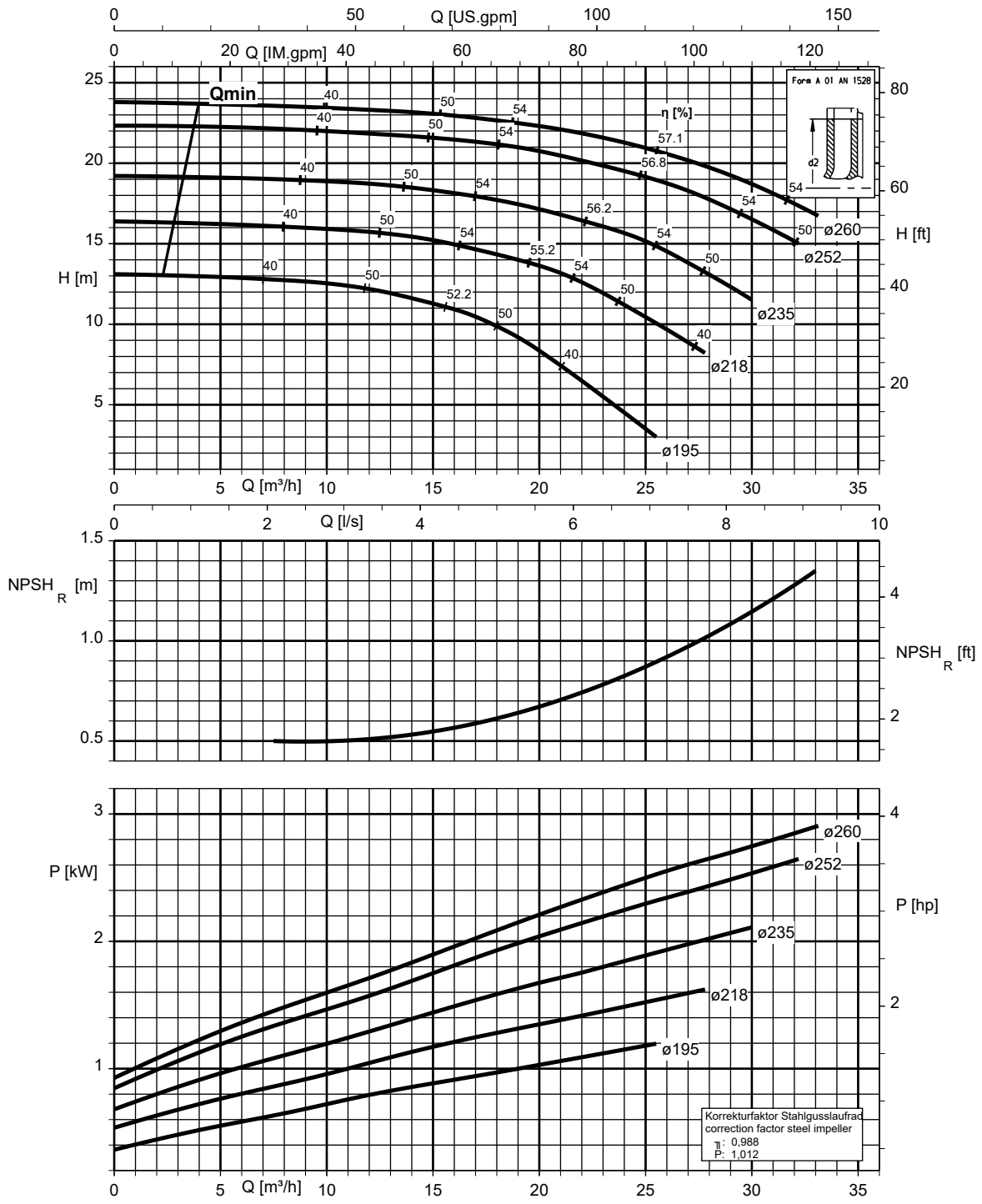

Vlet 065-040-315, n = 1450 rpm

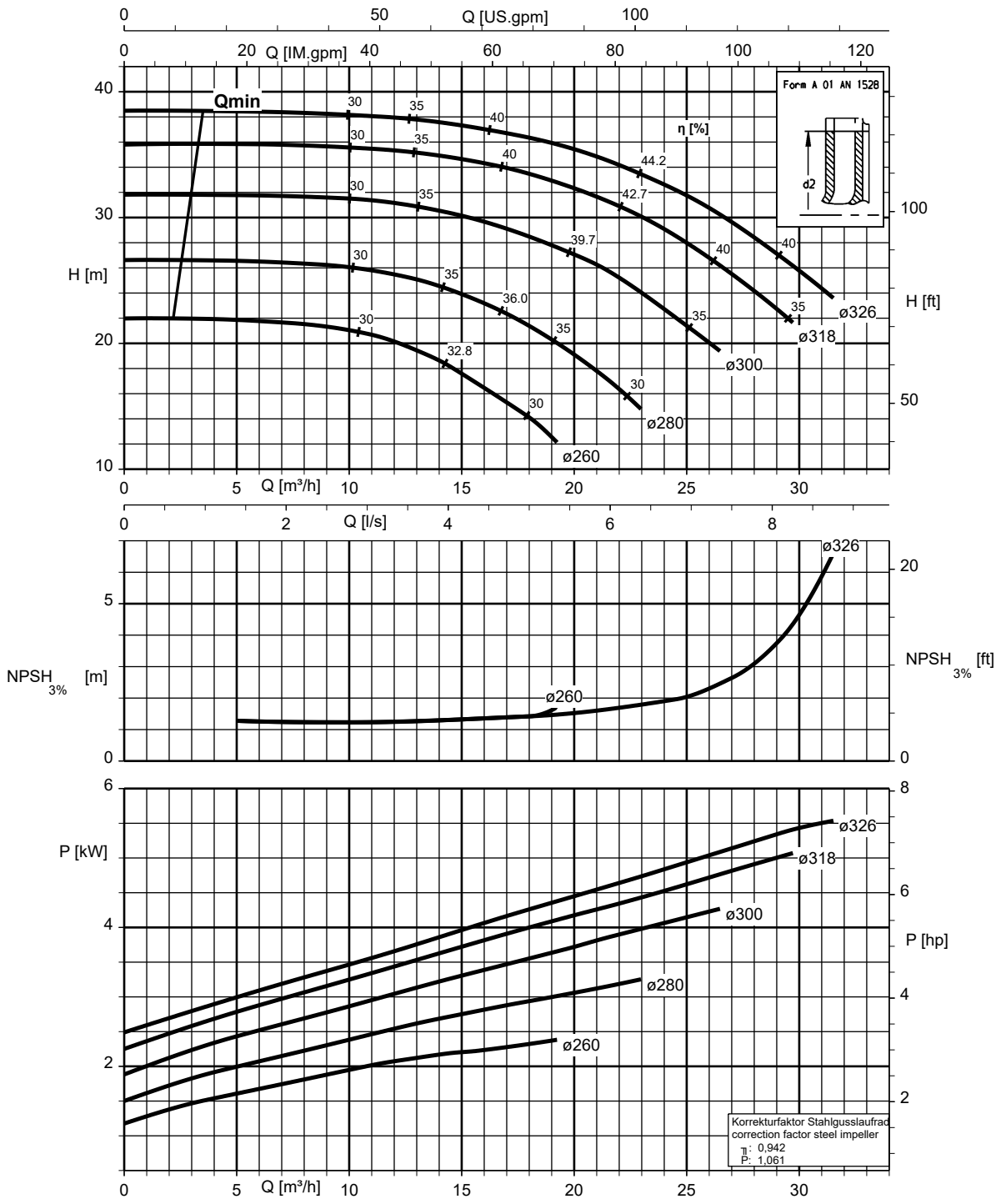

Vlet 065-050-125, n = 1450 rpm

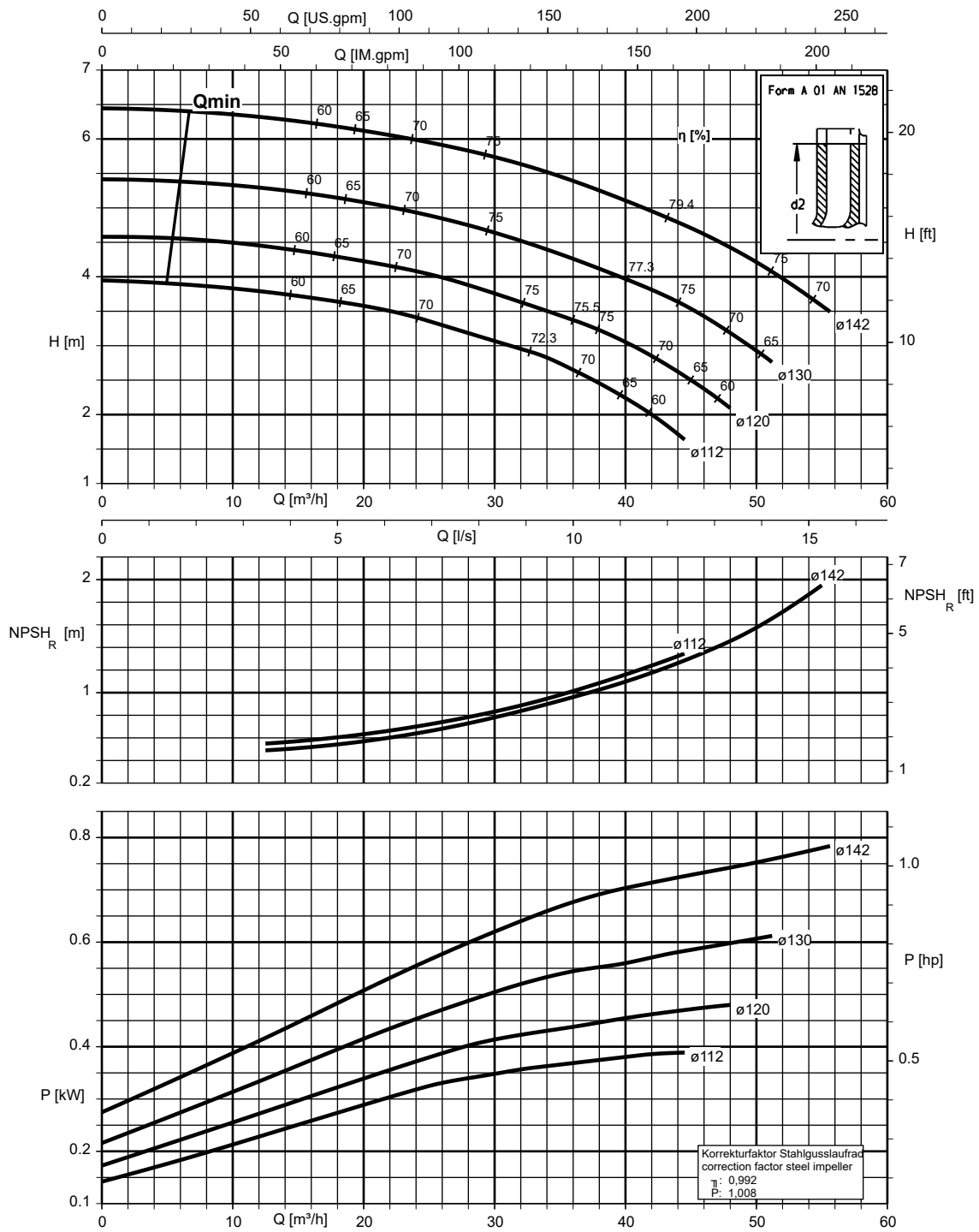

K1311.454/30/1

Vlet 065-050-160, n = 1450 rpm

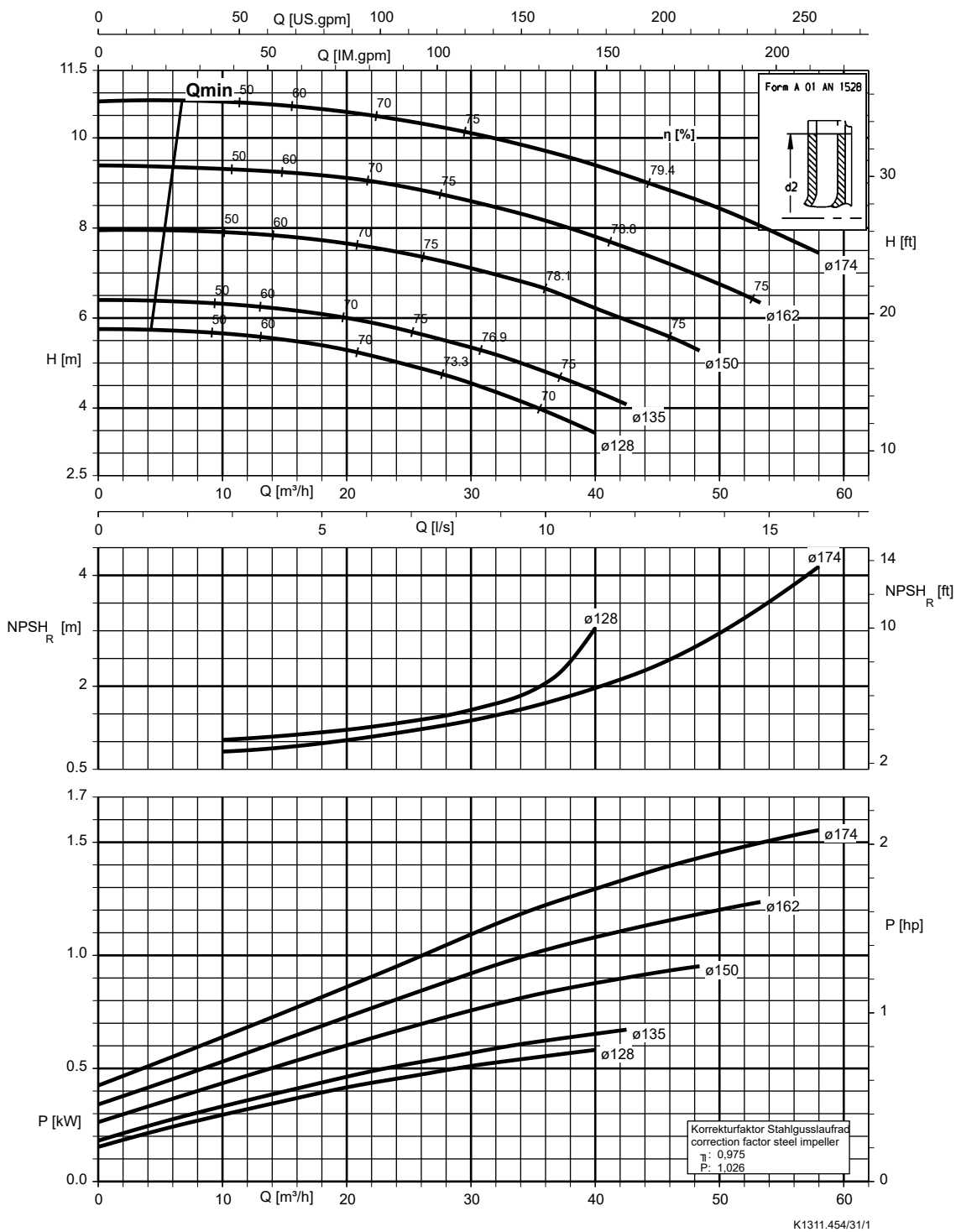

Vlet 065-050-200, n = 1450 rpm

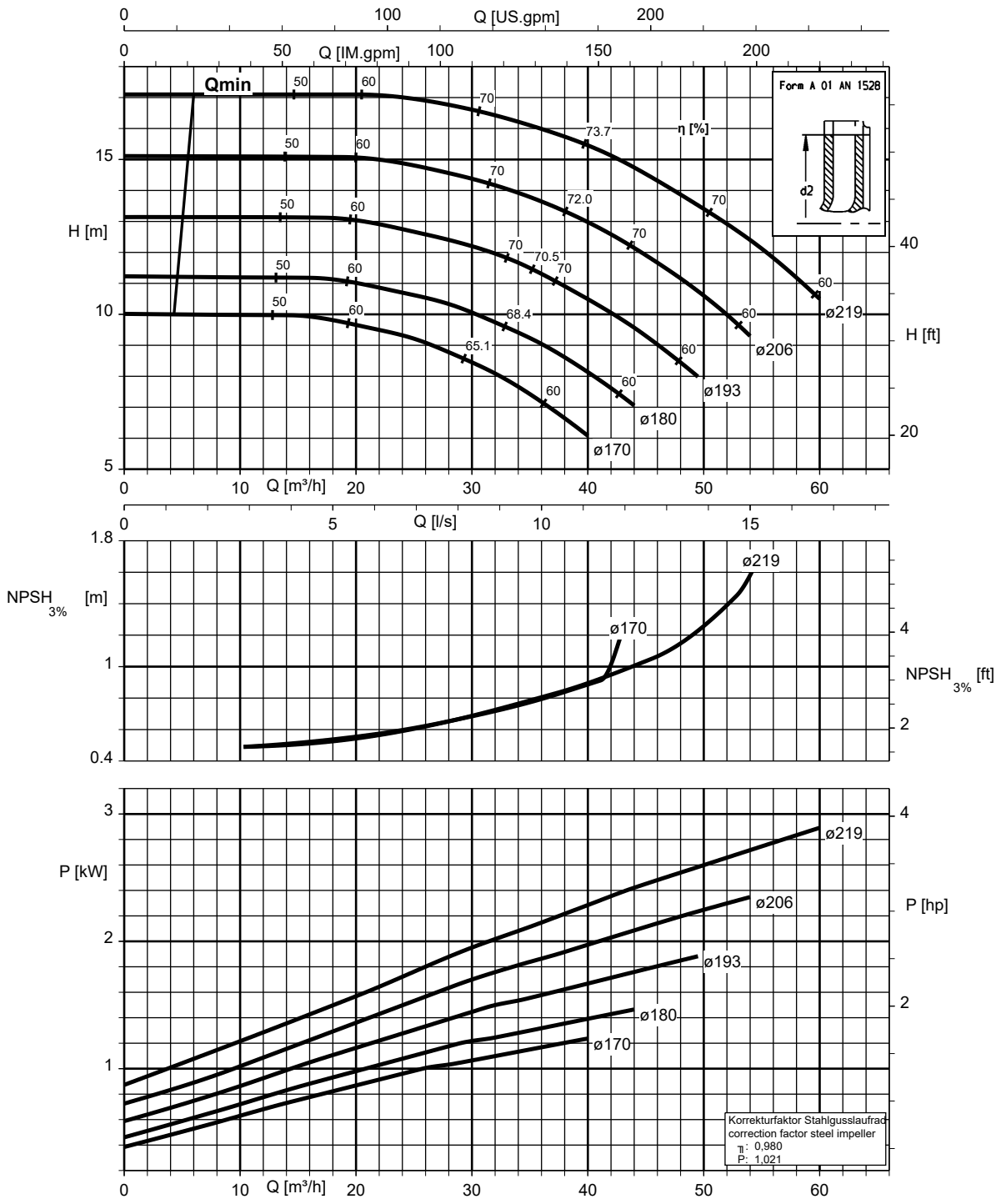

Vlet 065-050-250, n = 1450 rpm

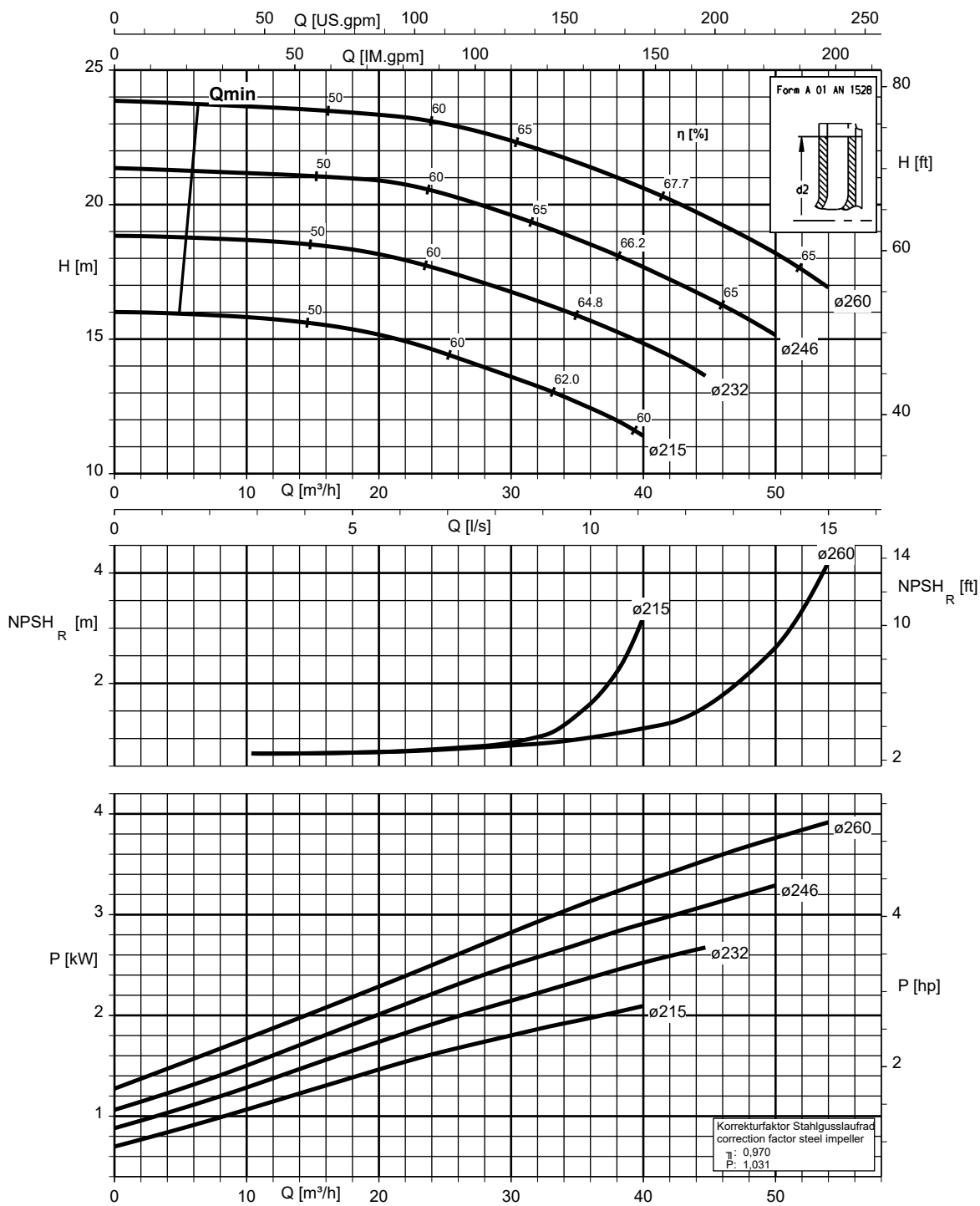

K1311.454/33/2

Vlet 065-050-315, n = 1450 rpm

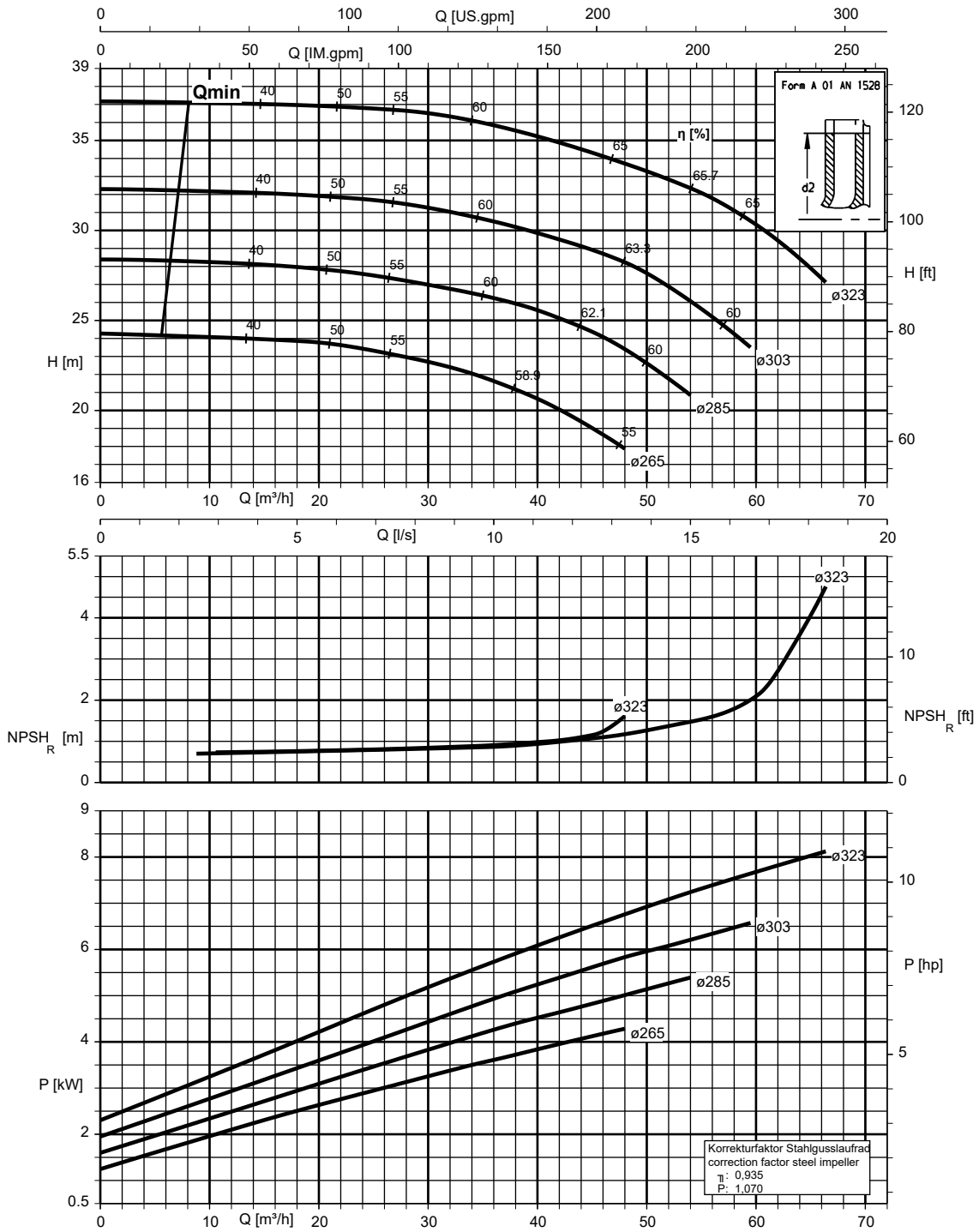

K1311.454/34/2

Vlet 080-065-125, n = 1450 rpm

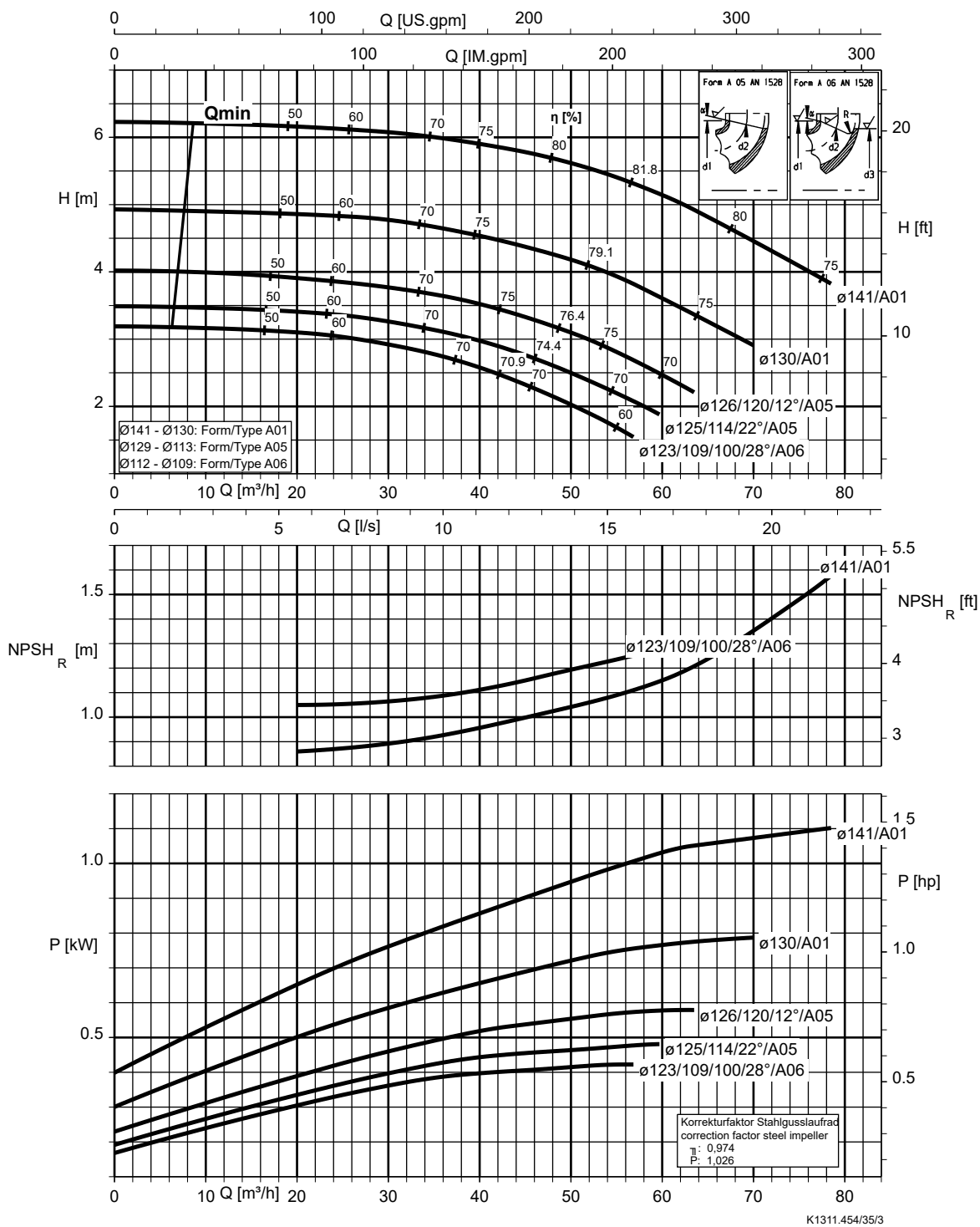

K1311.454/35/3

Vlet 080-065-160, n = 1450 rpm

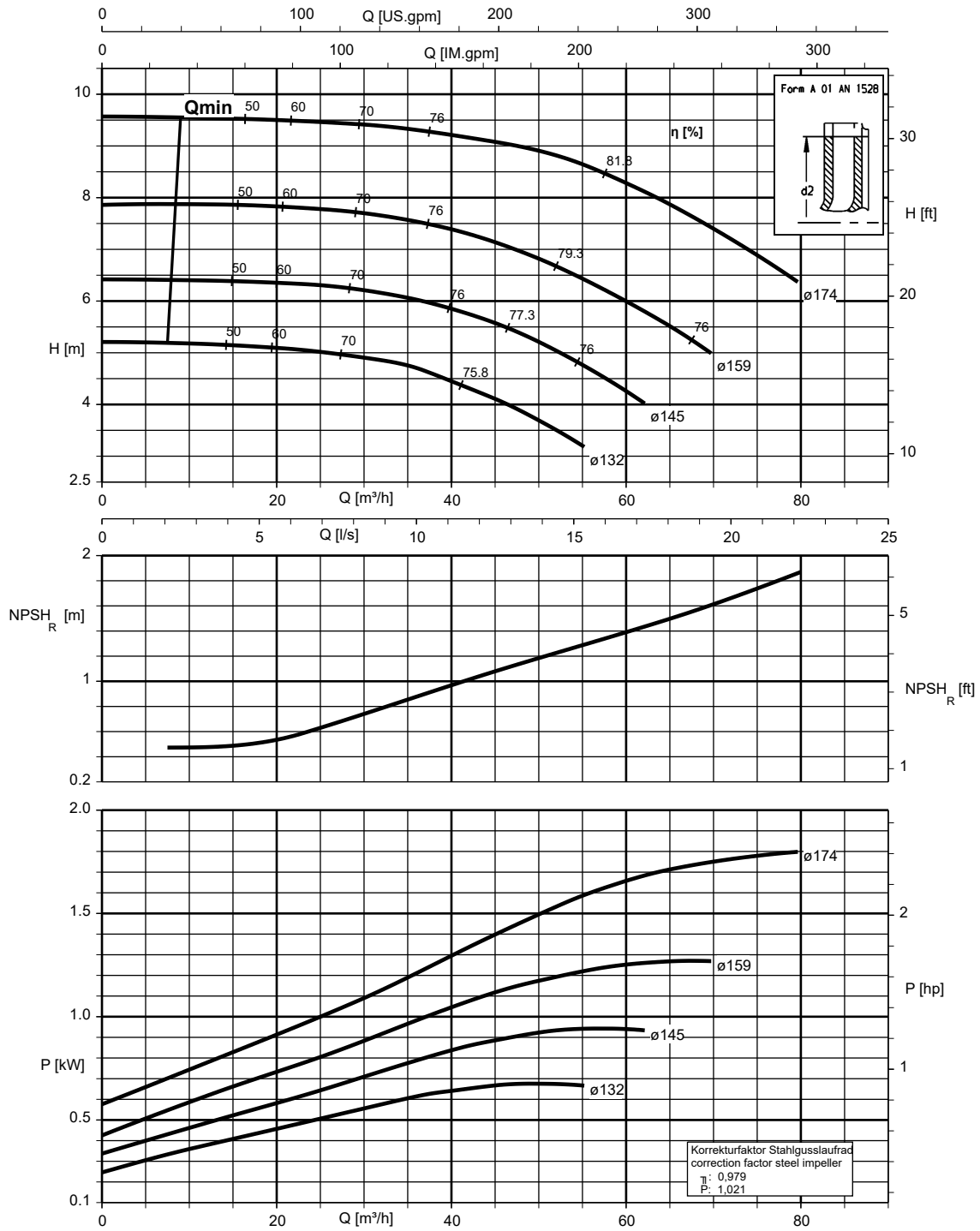

K1311.454/36/2

Vlet 080-065-200, n = 1450 rpm

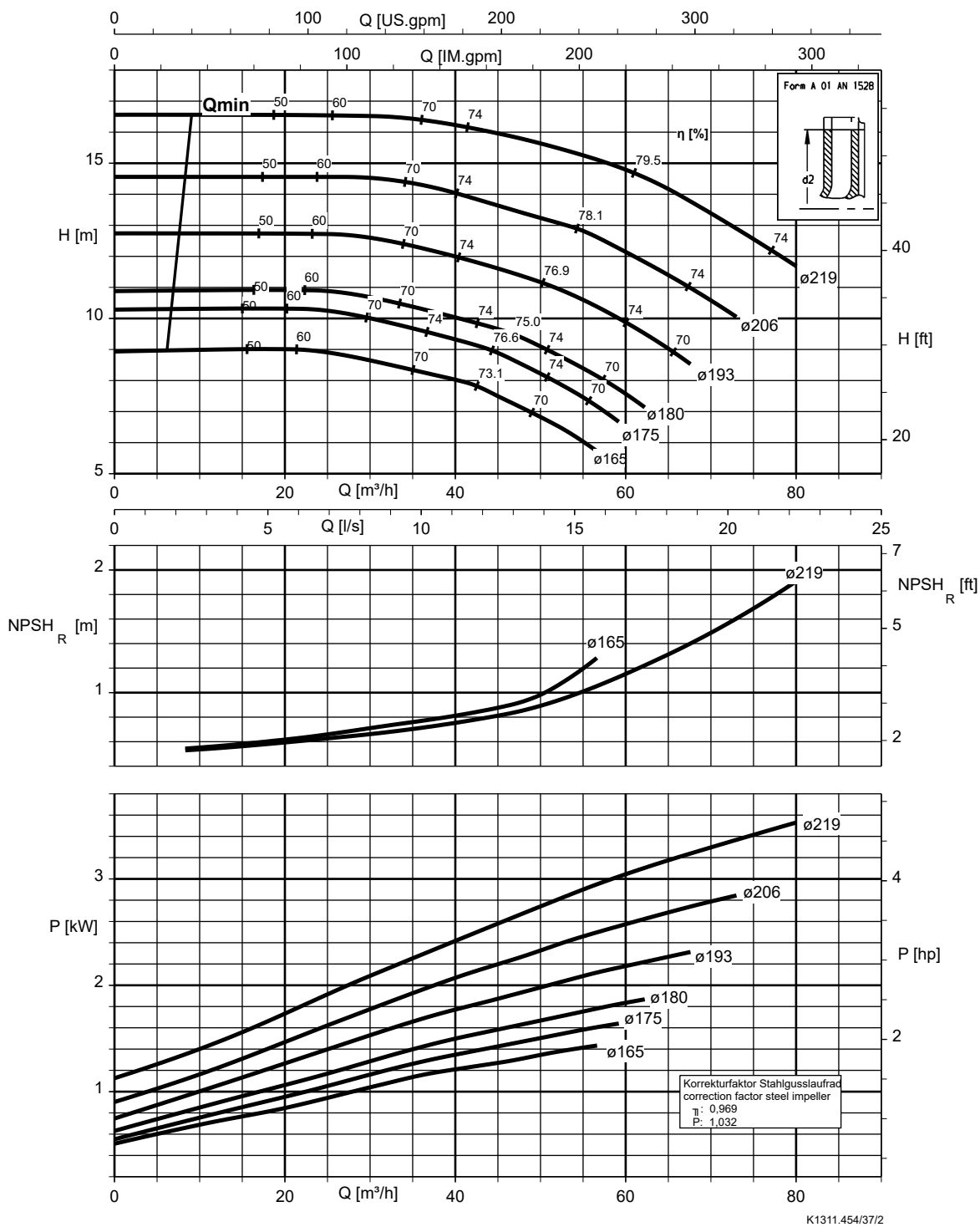

Vlet 080-065-250, n = 1450 rpm

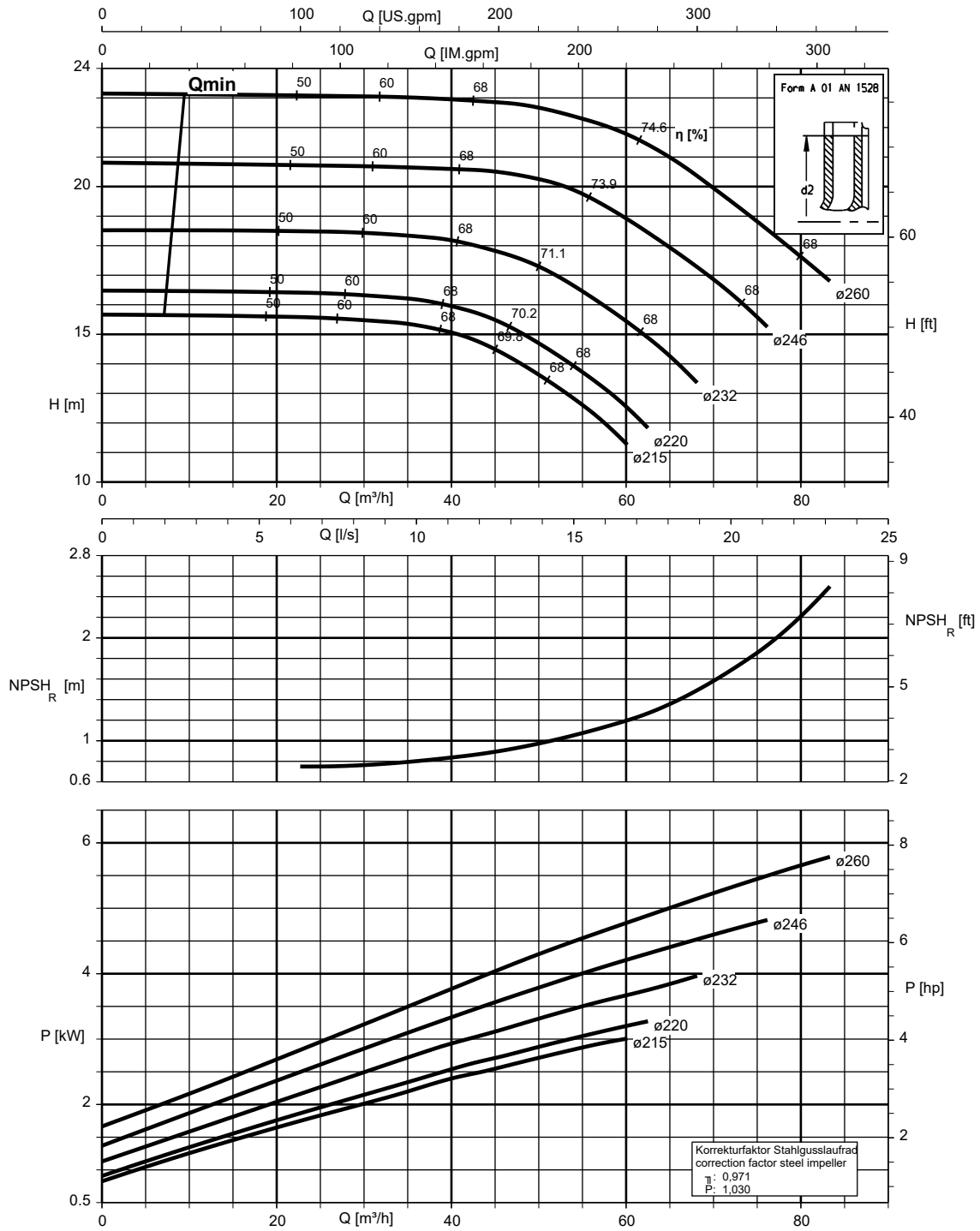

K1311.454/38/2

Vlet 080-065-315, n = 1450 rpm

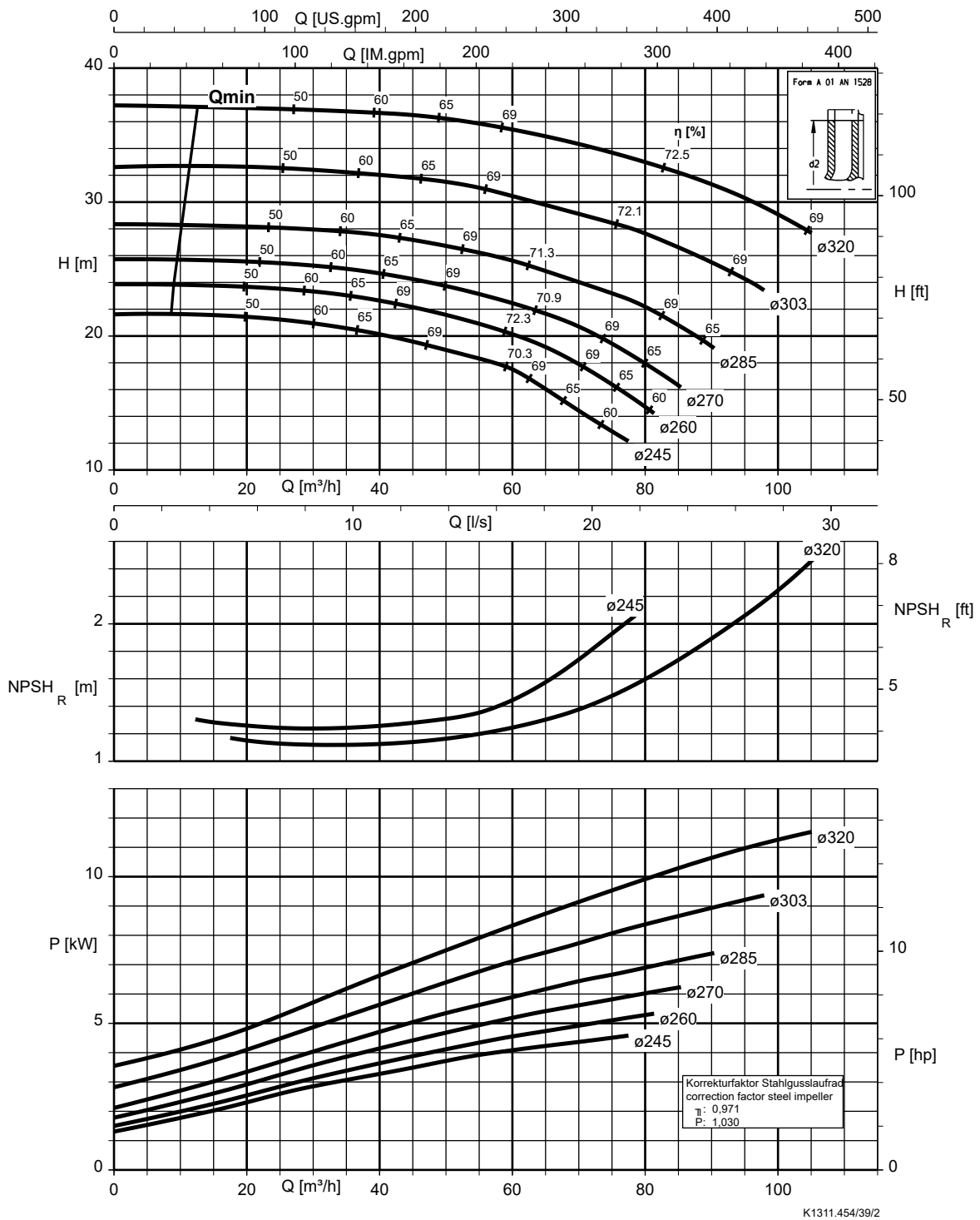

Vlet 100-080-160, n = 1450 rpm

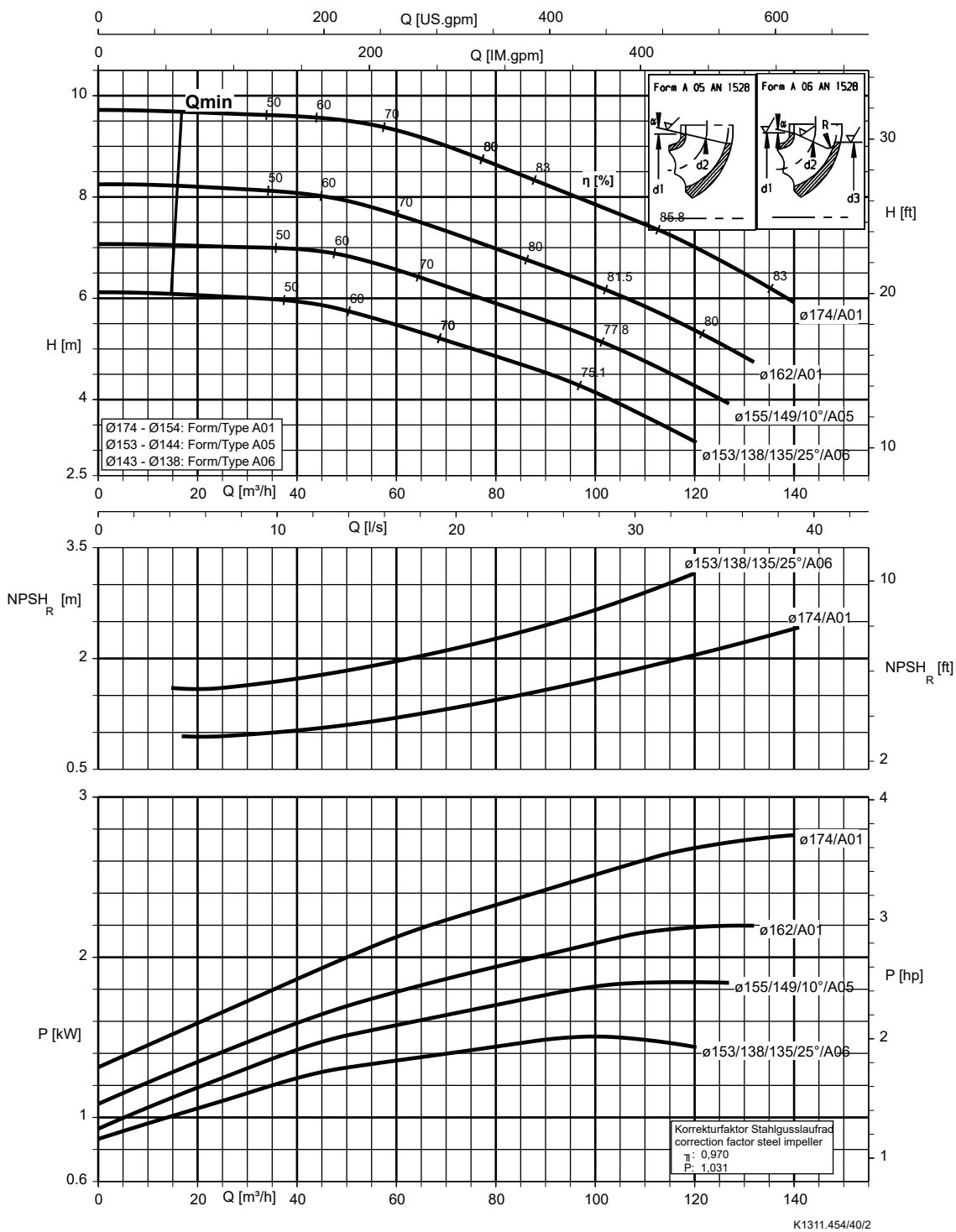

Vlet 100-080-200, n = 1450 rpm

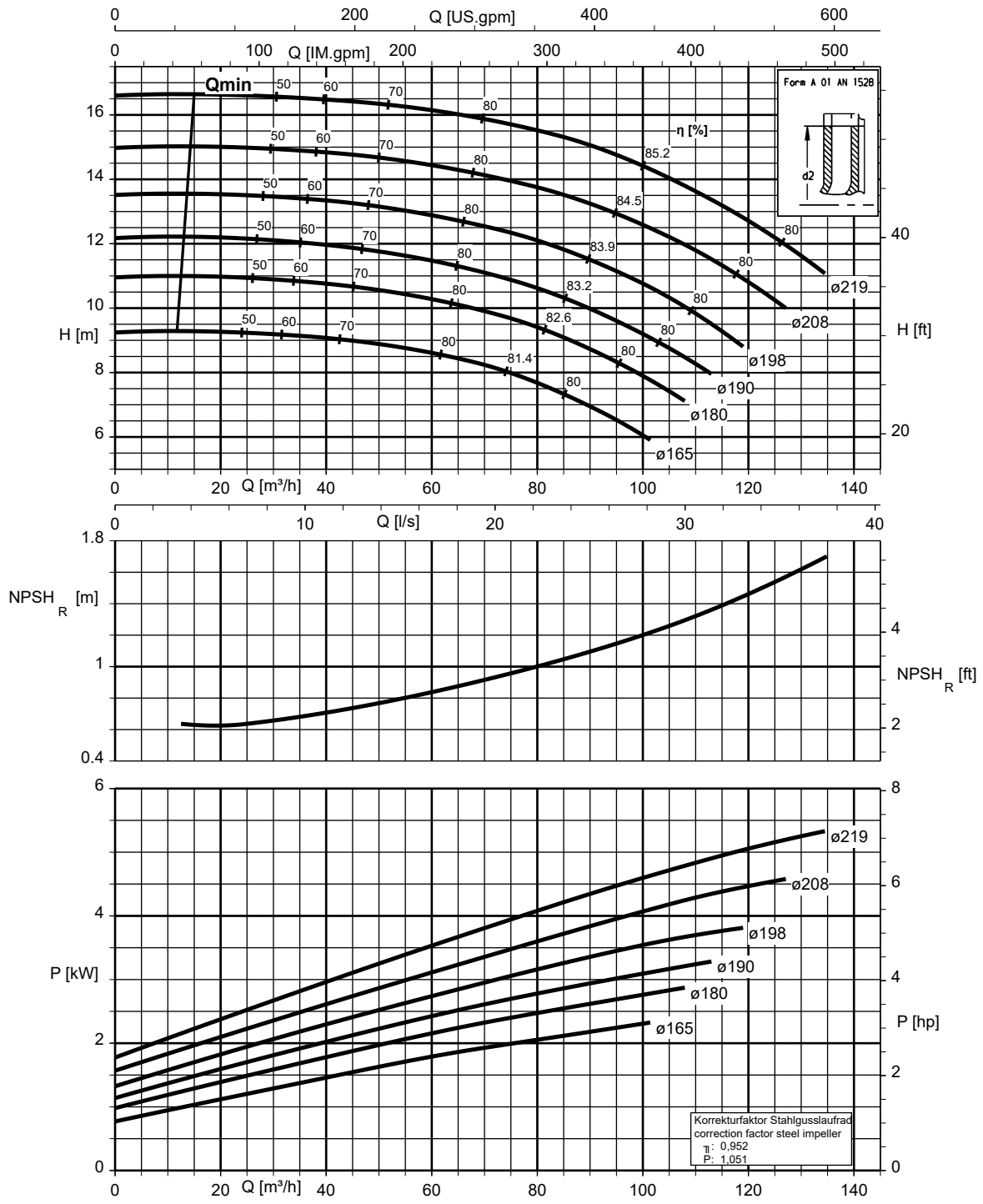

Vlet 100-080-250, n = 1450 rpm

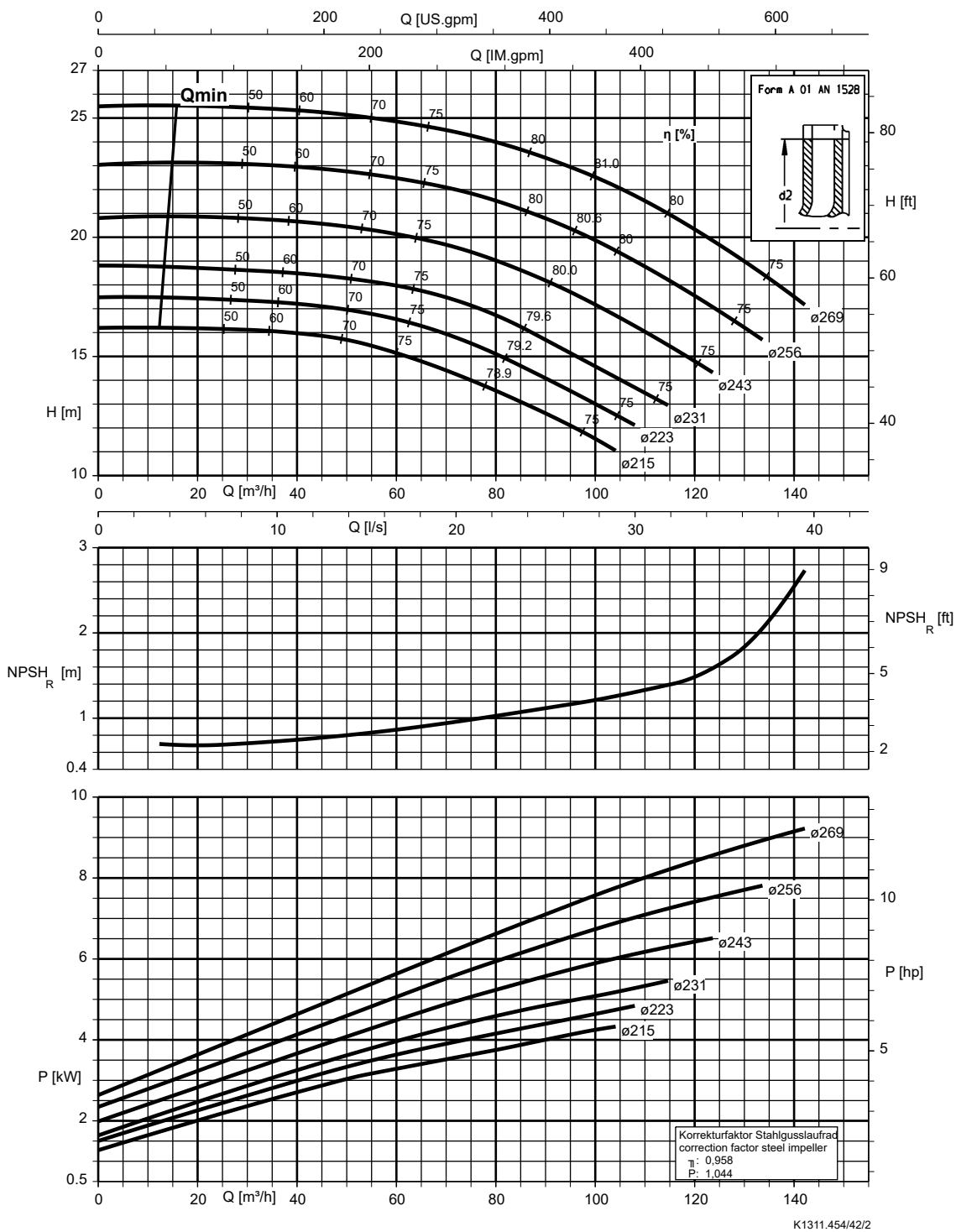

Vlet 100-080-315, n = 1450 rpm

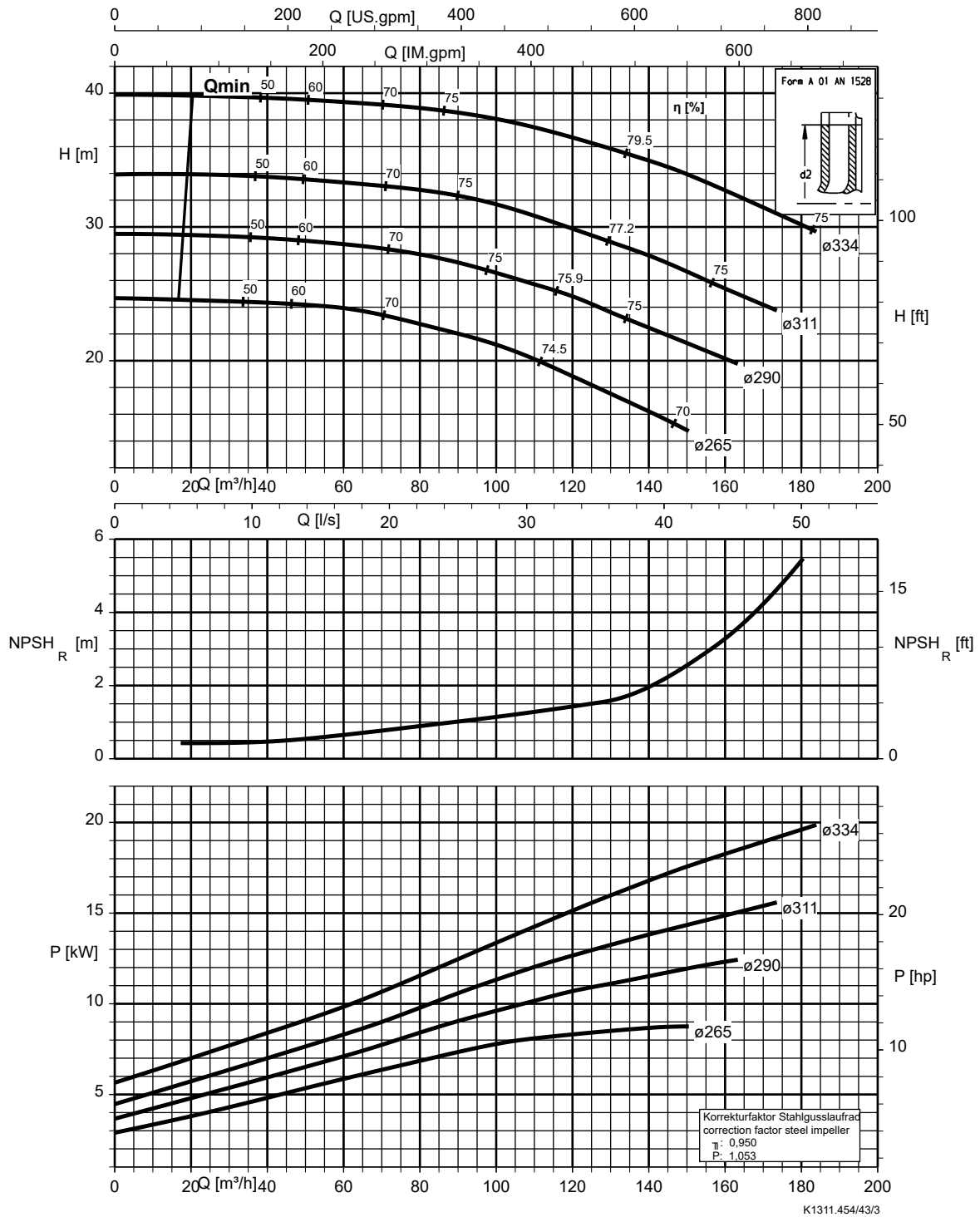

Vlet 100-080-400, n = 1450 rpm

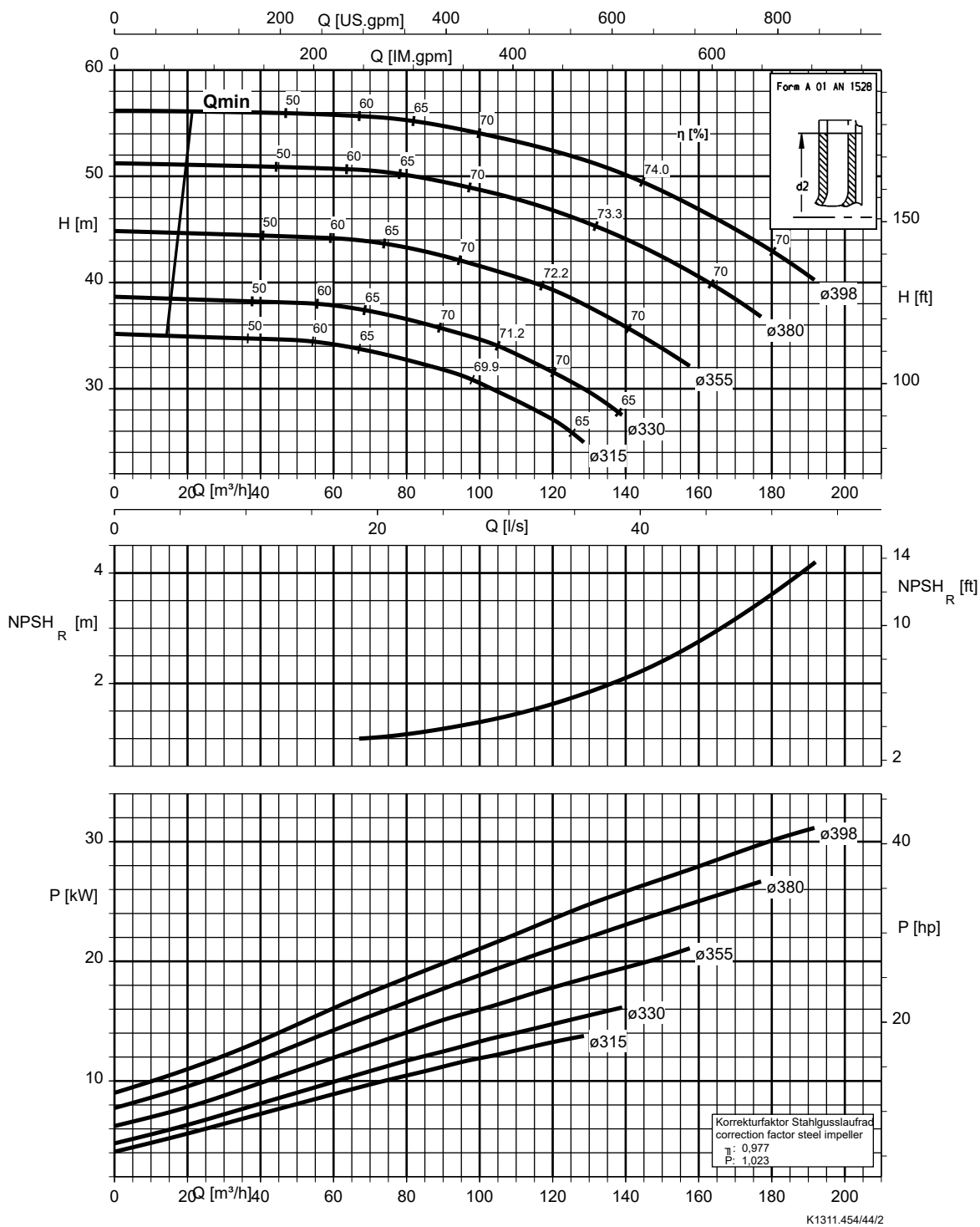

Vlet 125-100-160, n = 1450 rpm

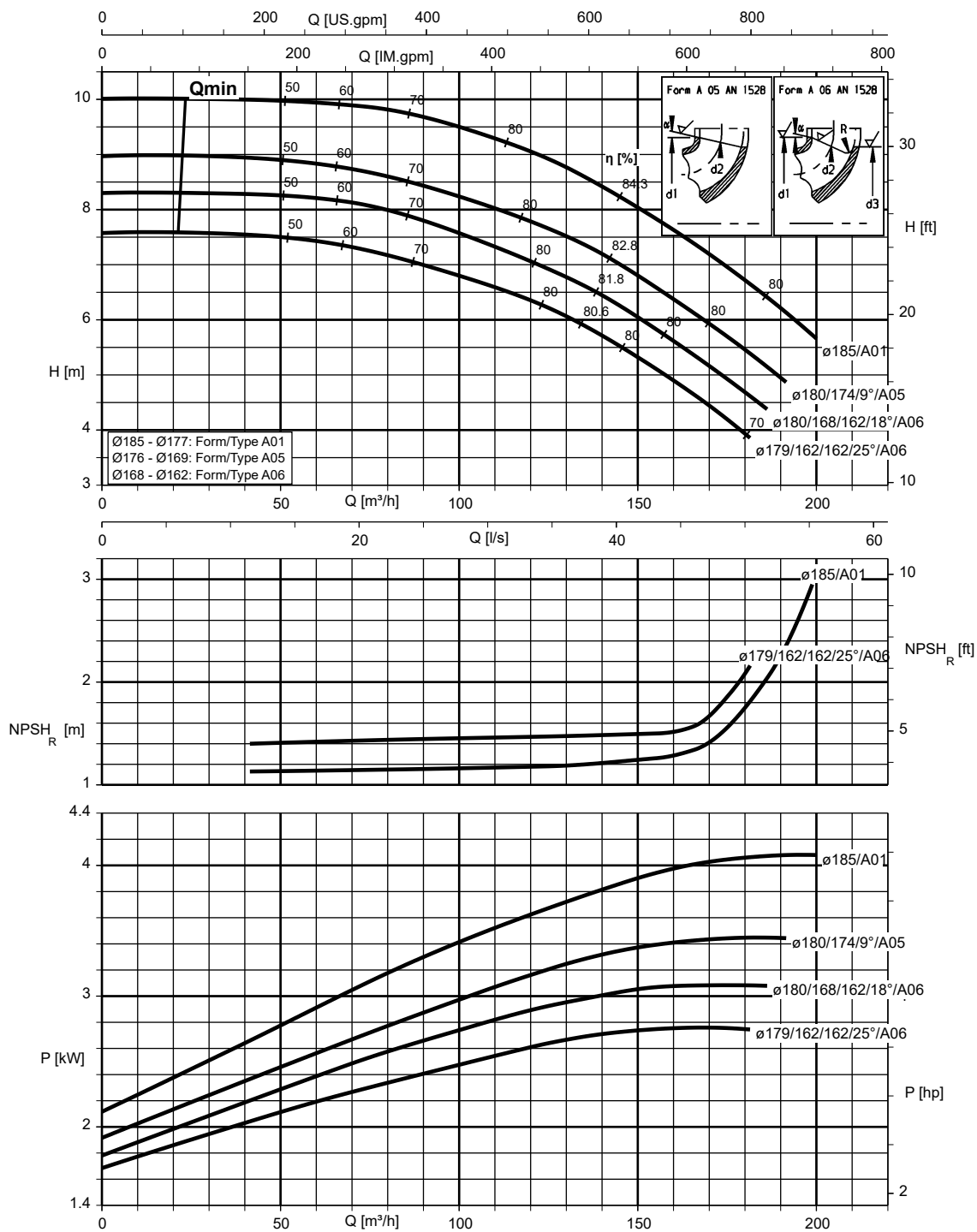

K1311.454/45/2

Vlet 125-100-200, n = 1450 rpm

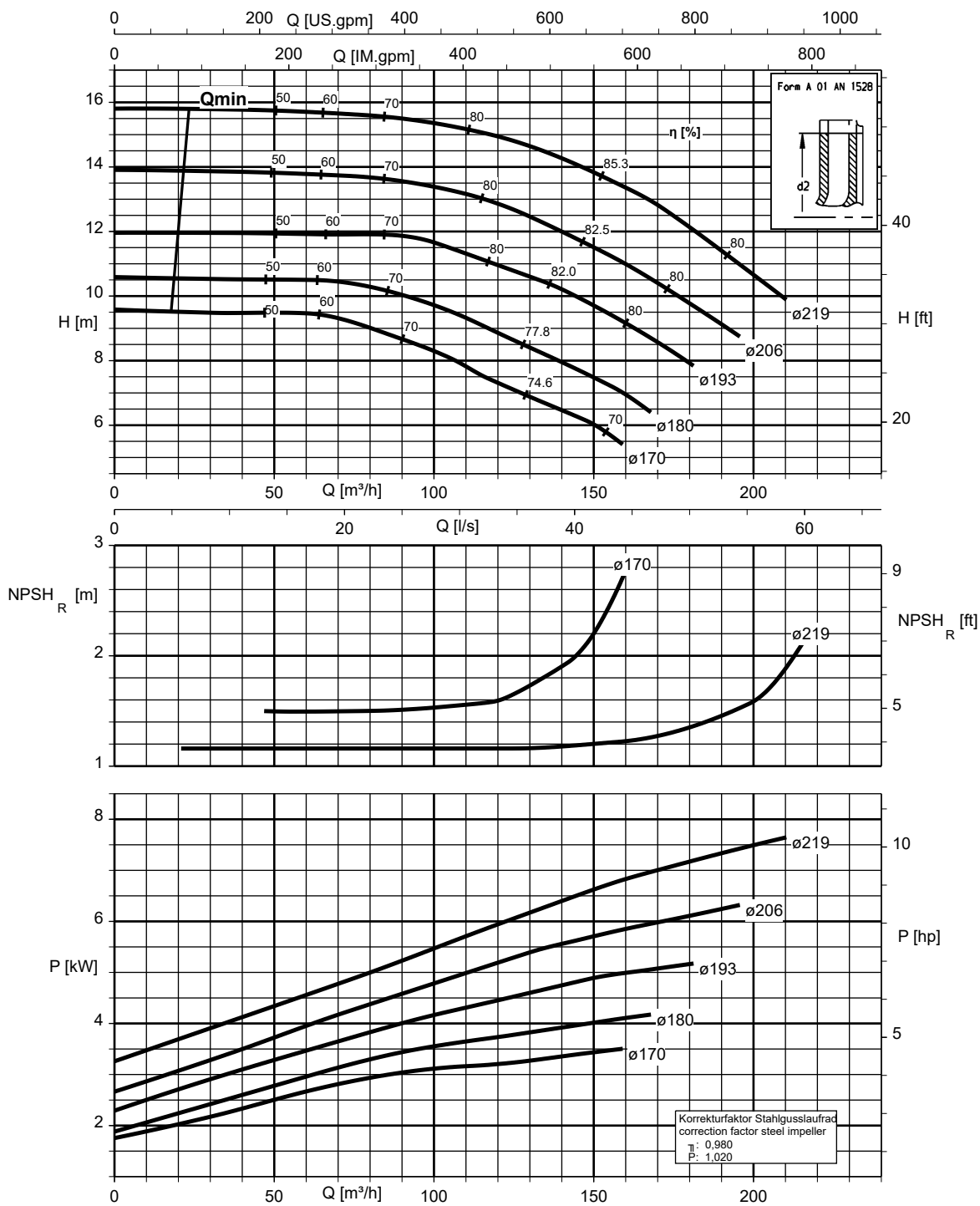

K1311.454/46/2

Vlet 125-100-250, n = 1450 rpm

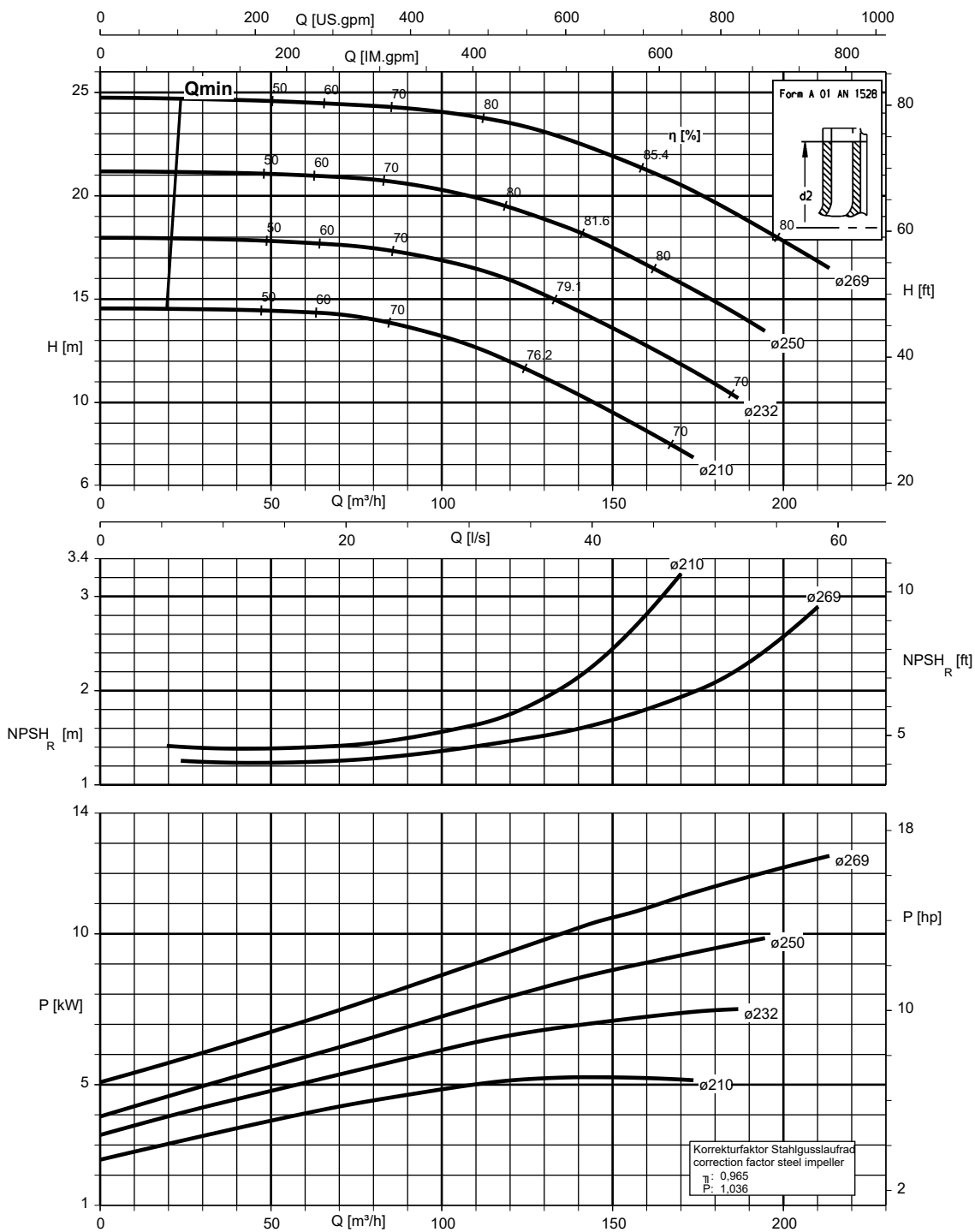

Vlet 125-100-315, n = 1450 rpm

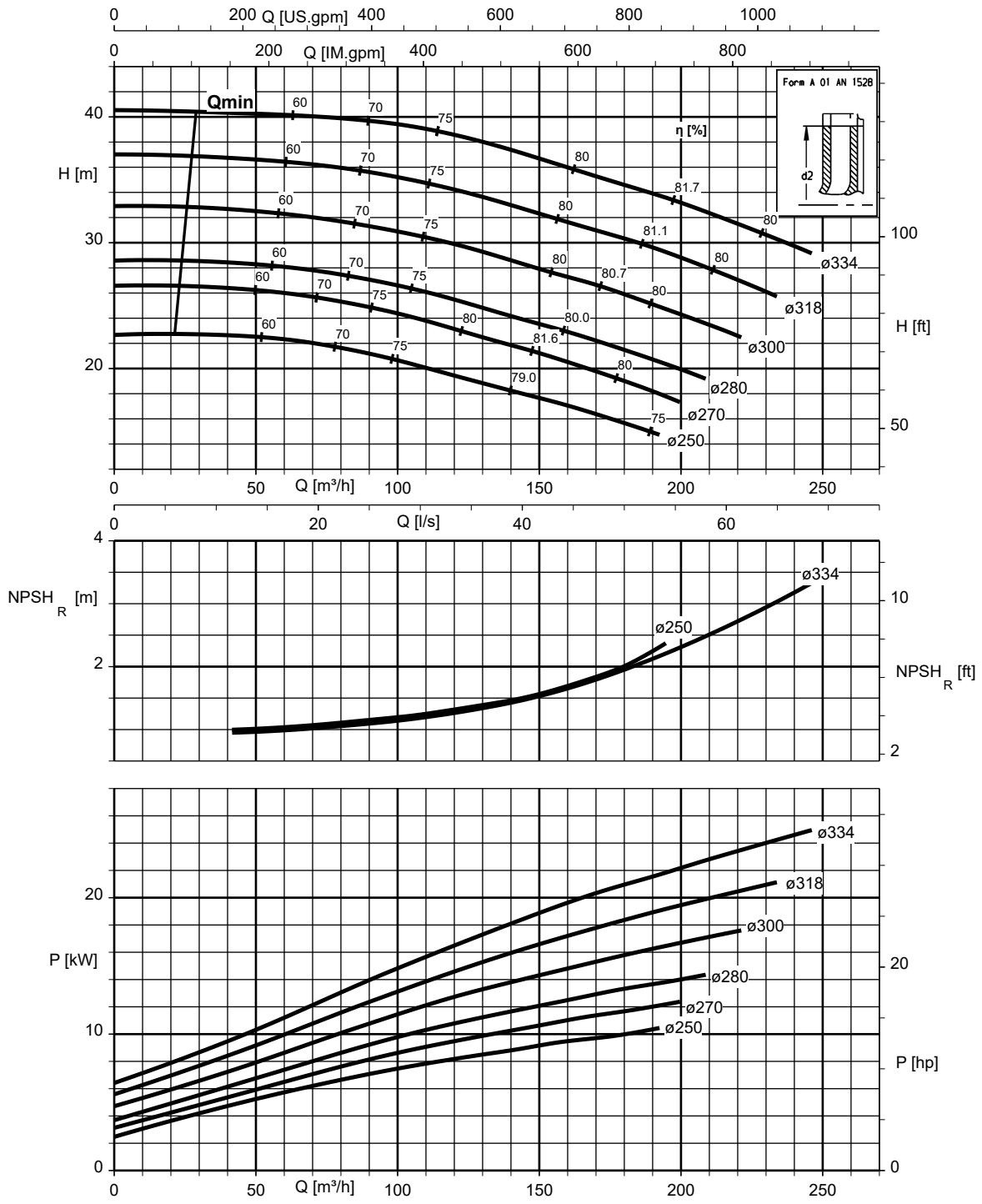

Vlet 125-100-400, n = 1450 rpm

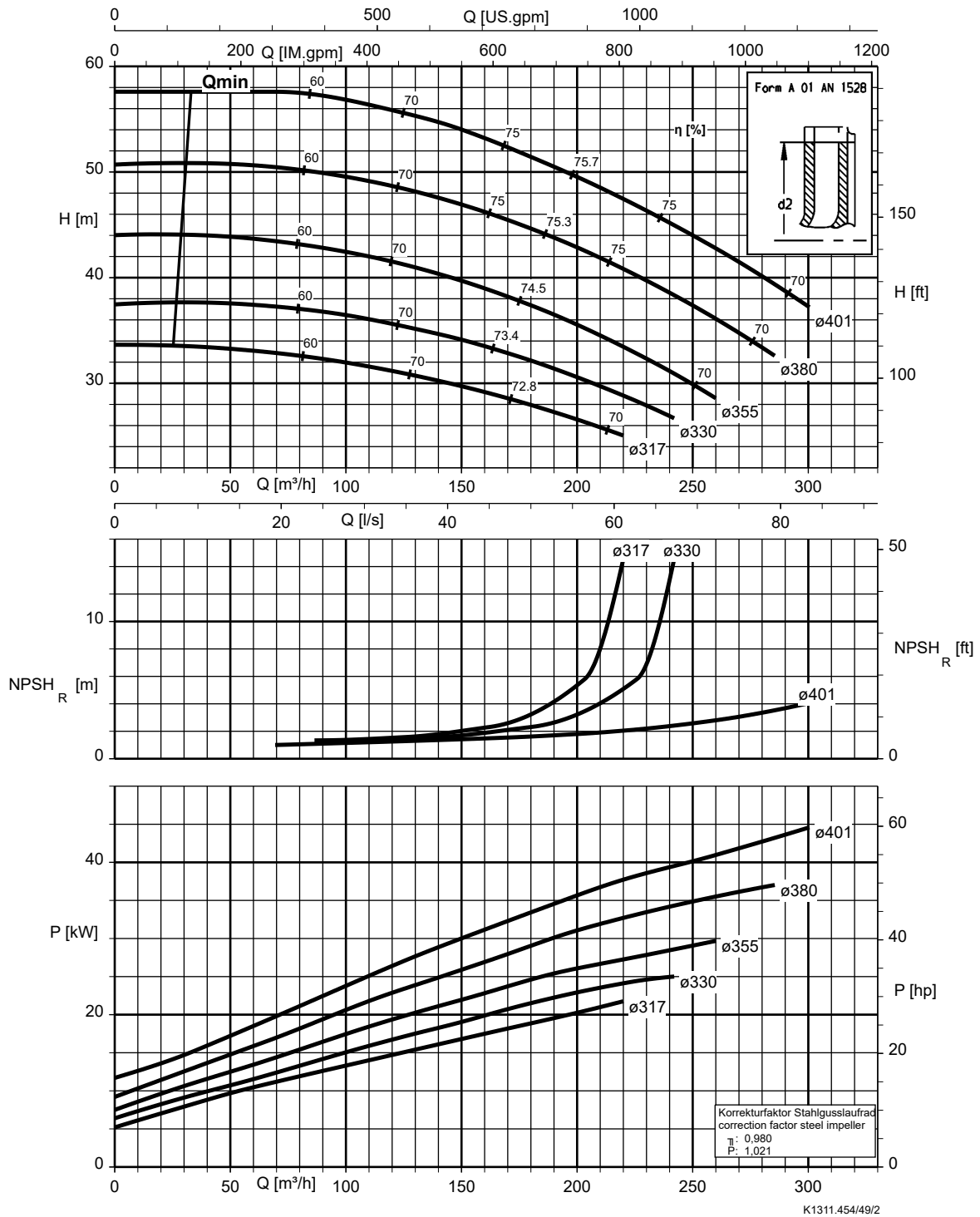

Vlet 150-125-200, n = 1450 rpm

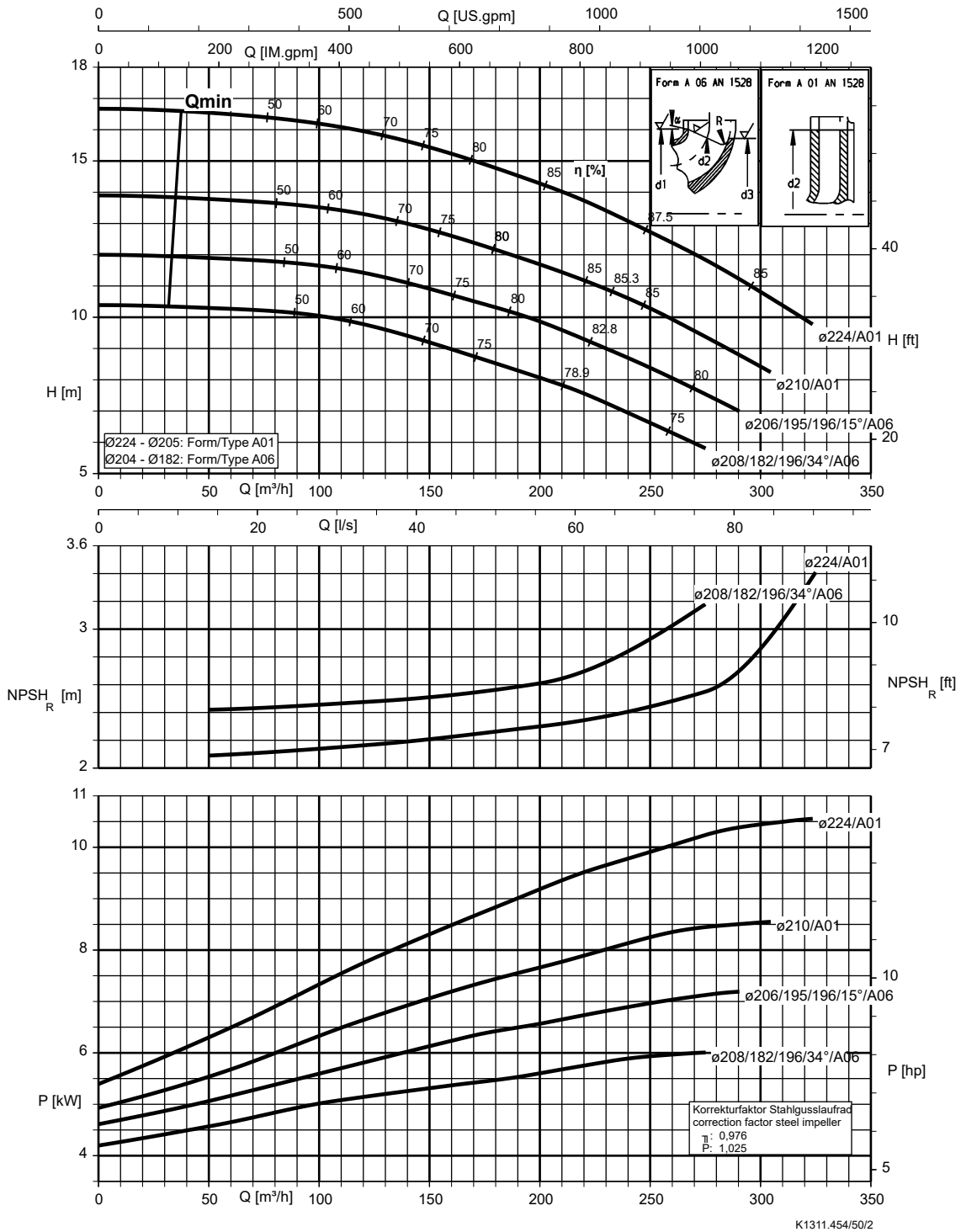

Vlet 150-125-250, n = 1450 rpm

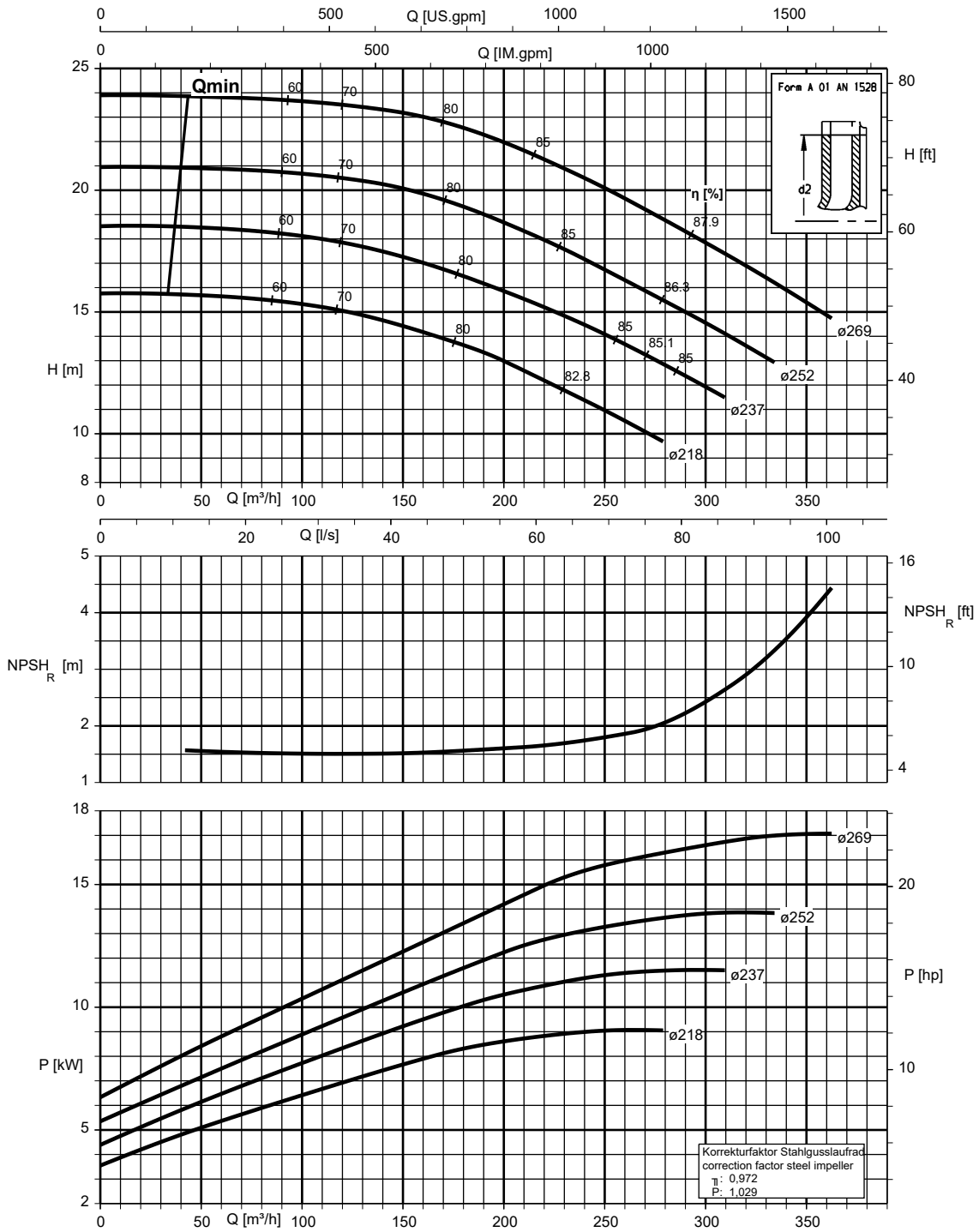

Vlet 150-125-315, n = 1450 rpm

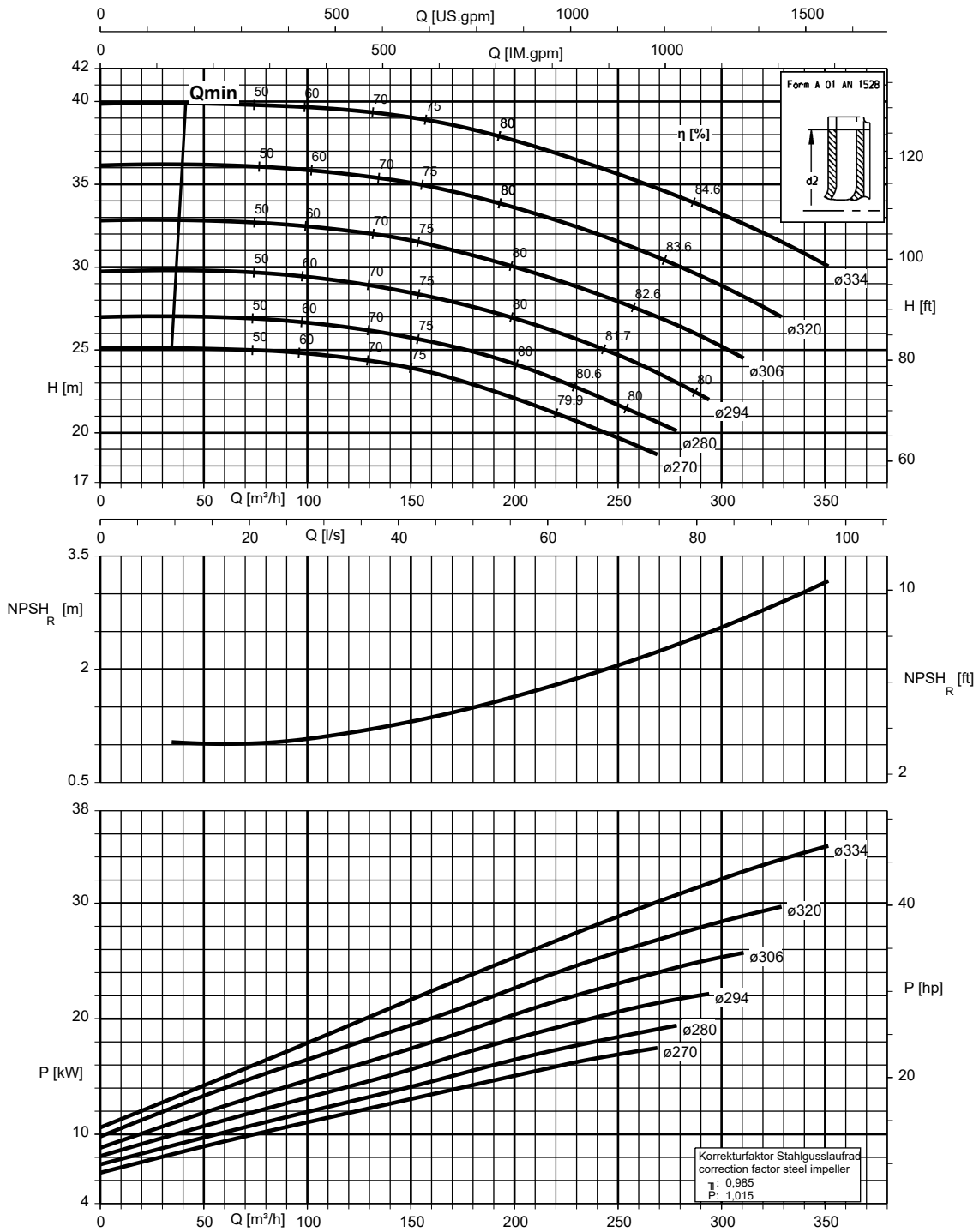

K1311.454/52/2

Vlet 150-125-400, n = 1450 rpm

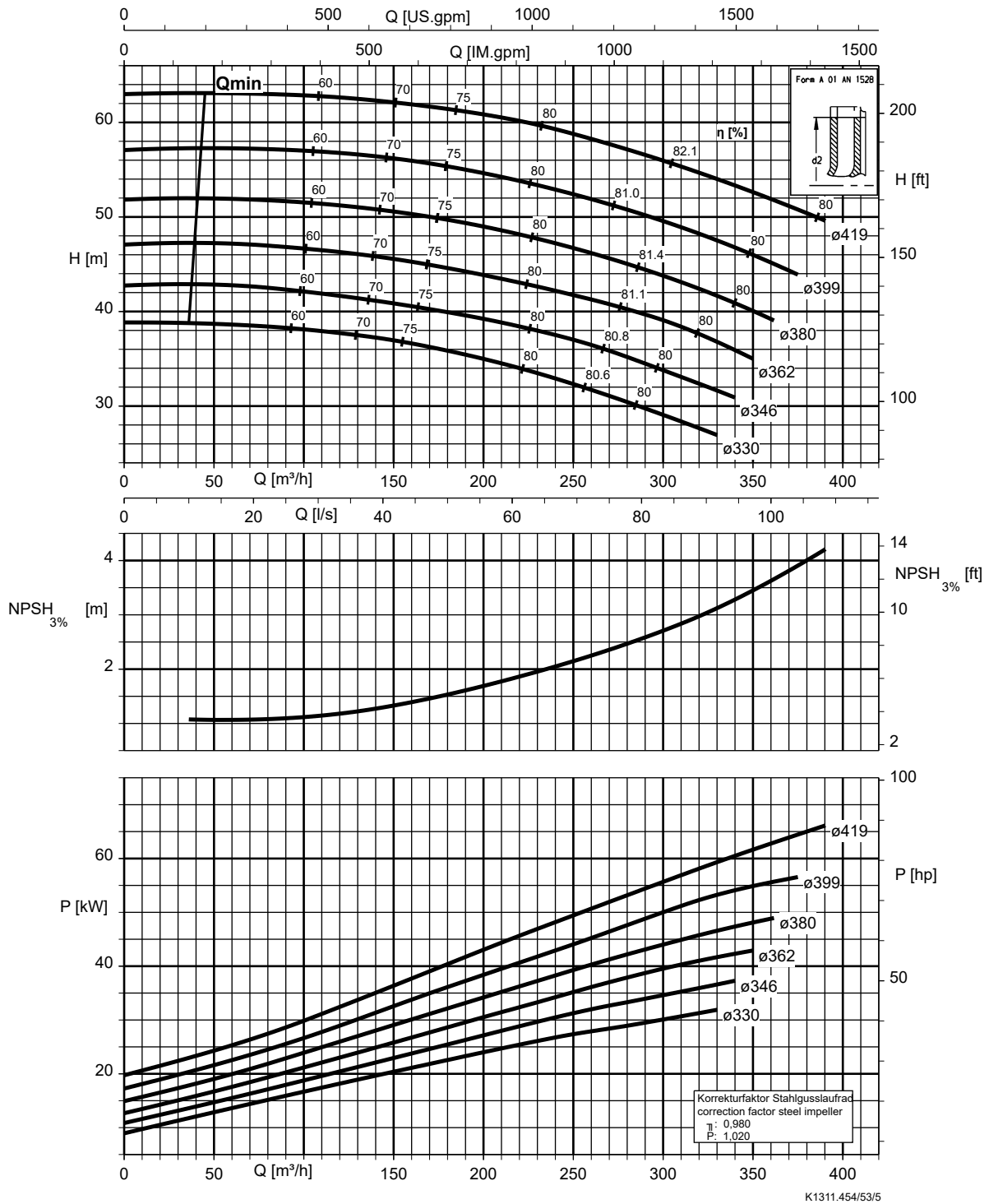

Vlet 150-125-510, n = 1450 rpm

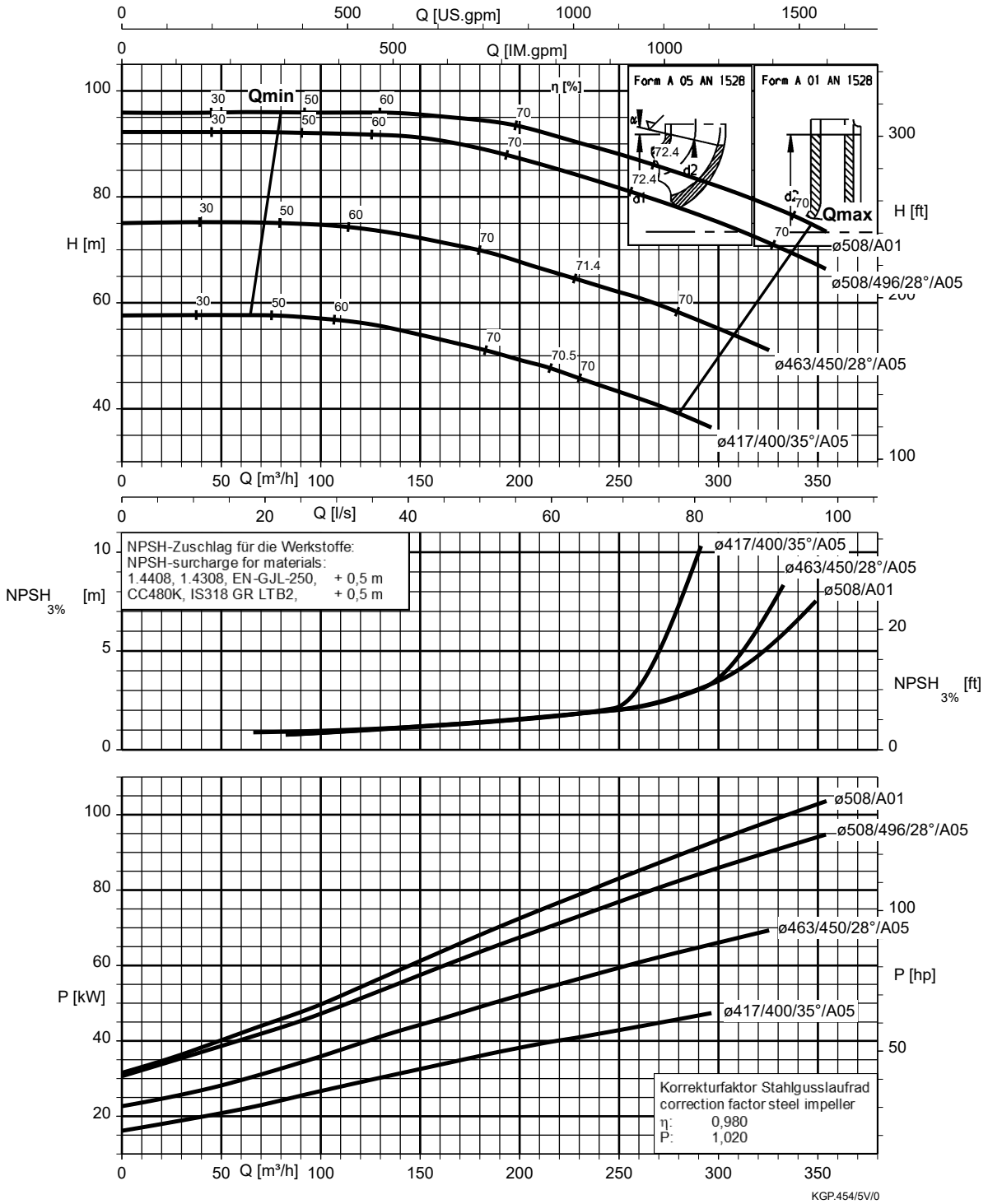

Vlet 200-150-200, n = 1450 rpm

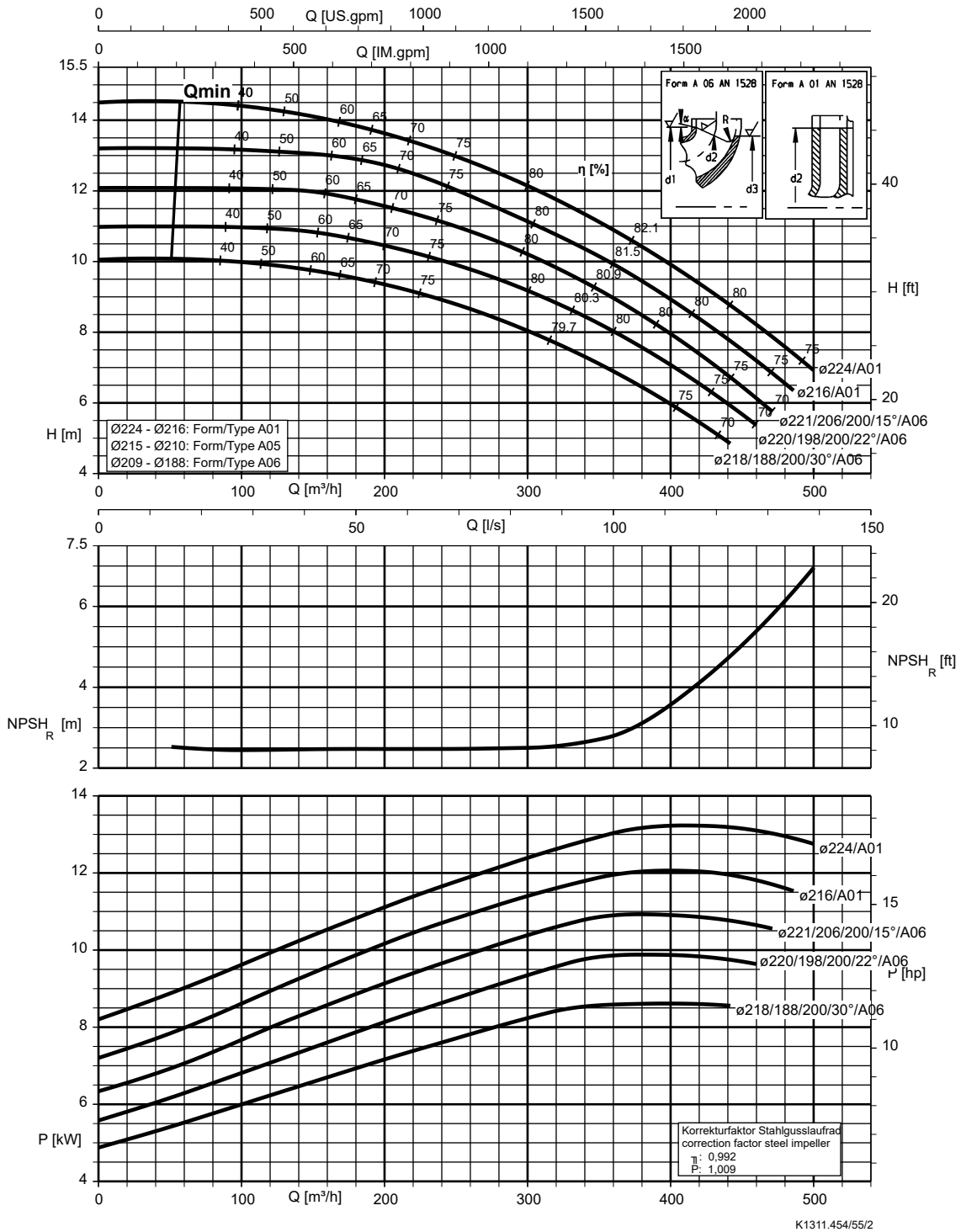

Vlet 200-150-250, n = 1450 rpm

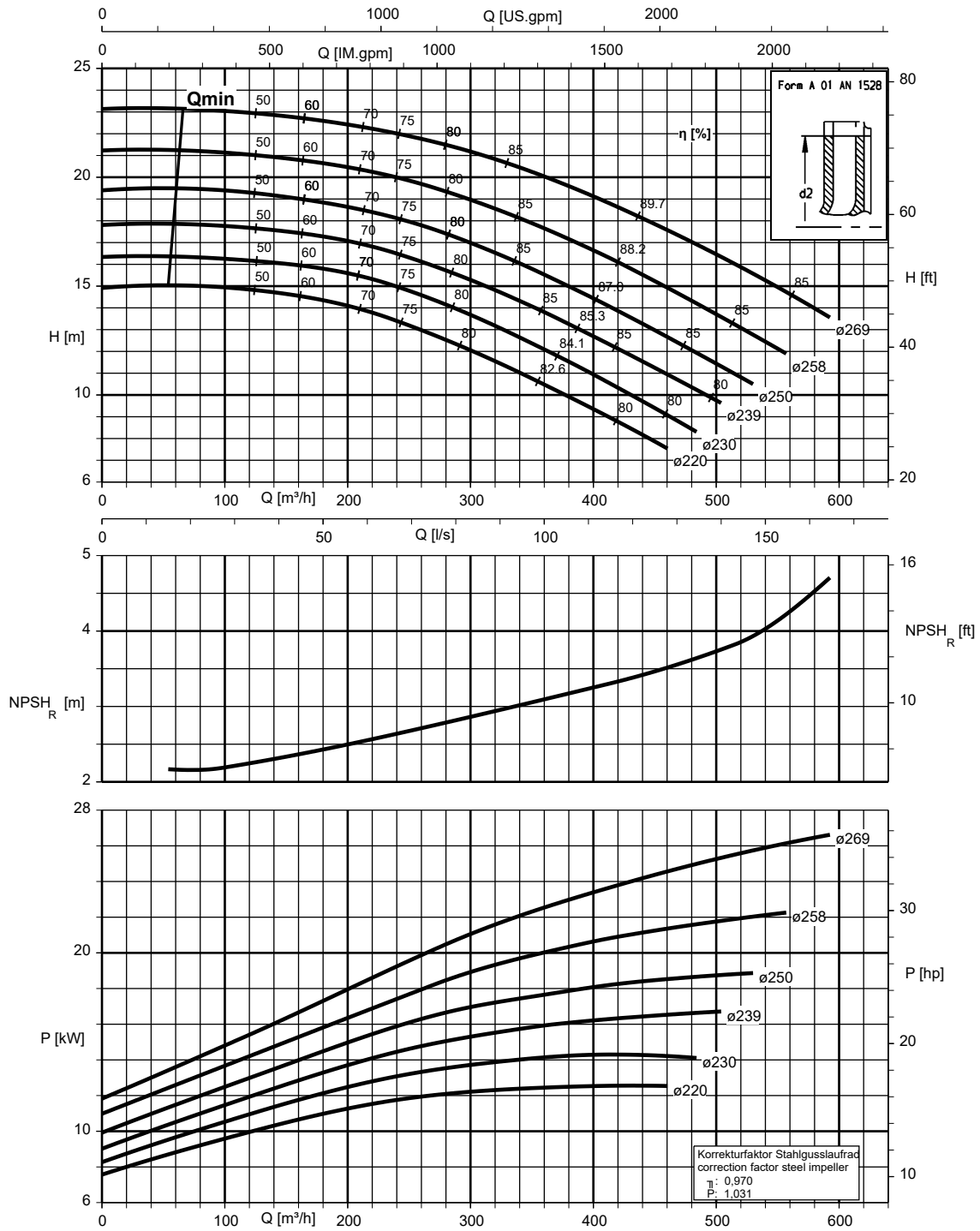

K1311.454/56/2

Vlet 200-150-315, n = 1450 rpm

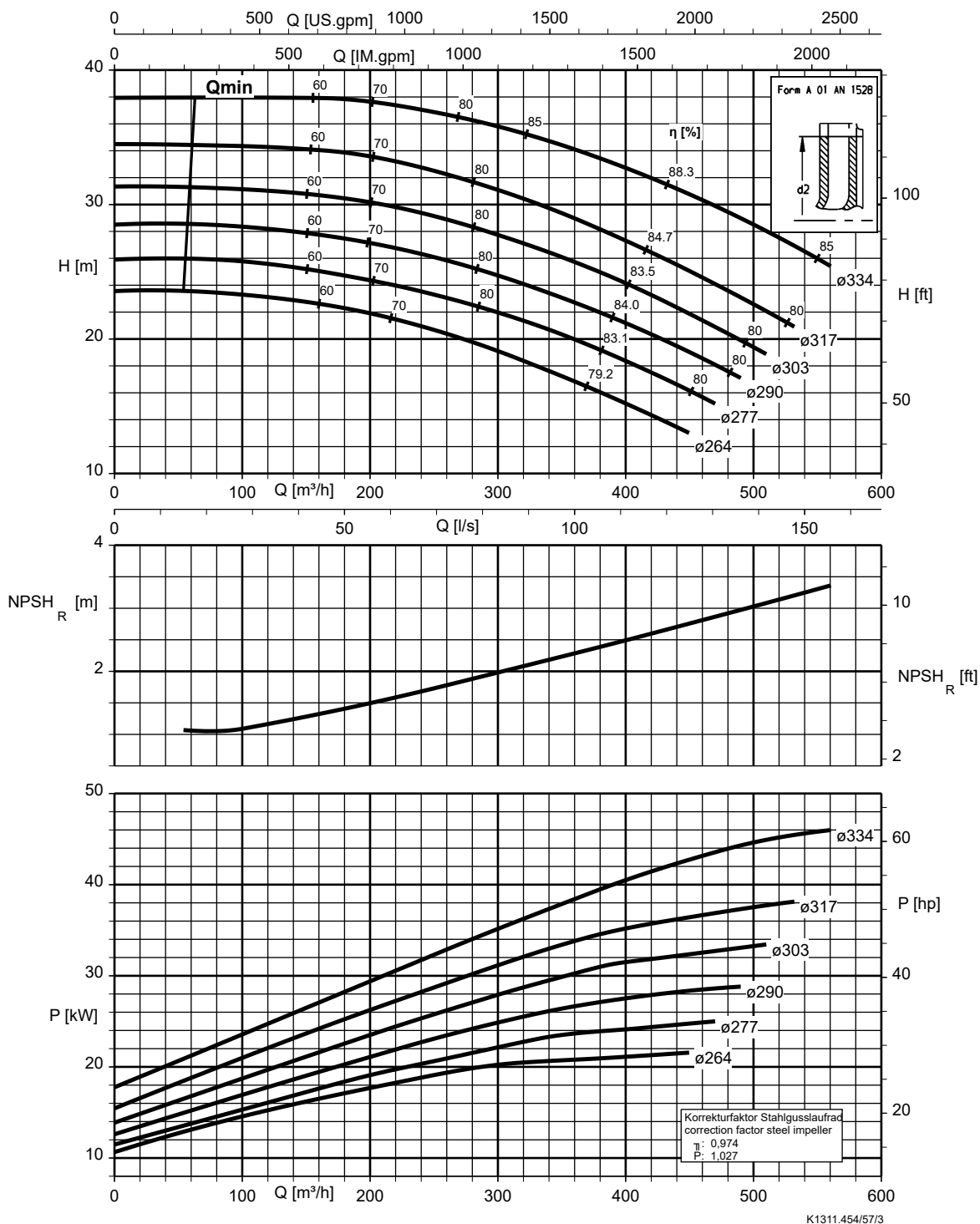

K1311.454/57/3

Vlet 200-150-400, n = 1450 rpm

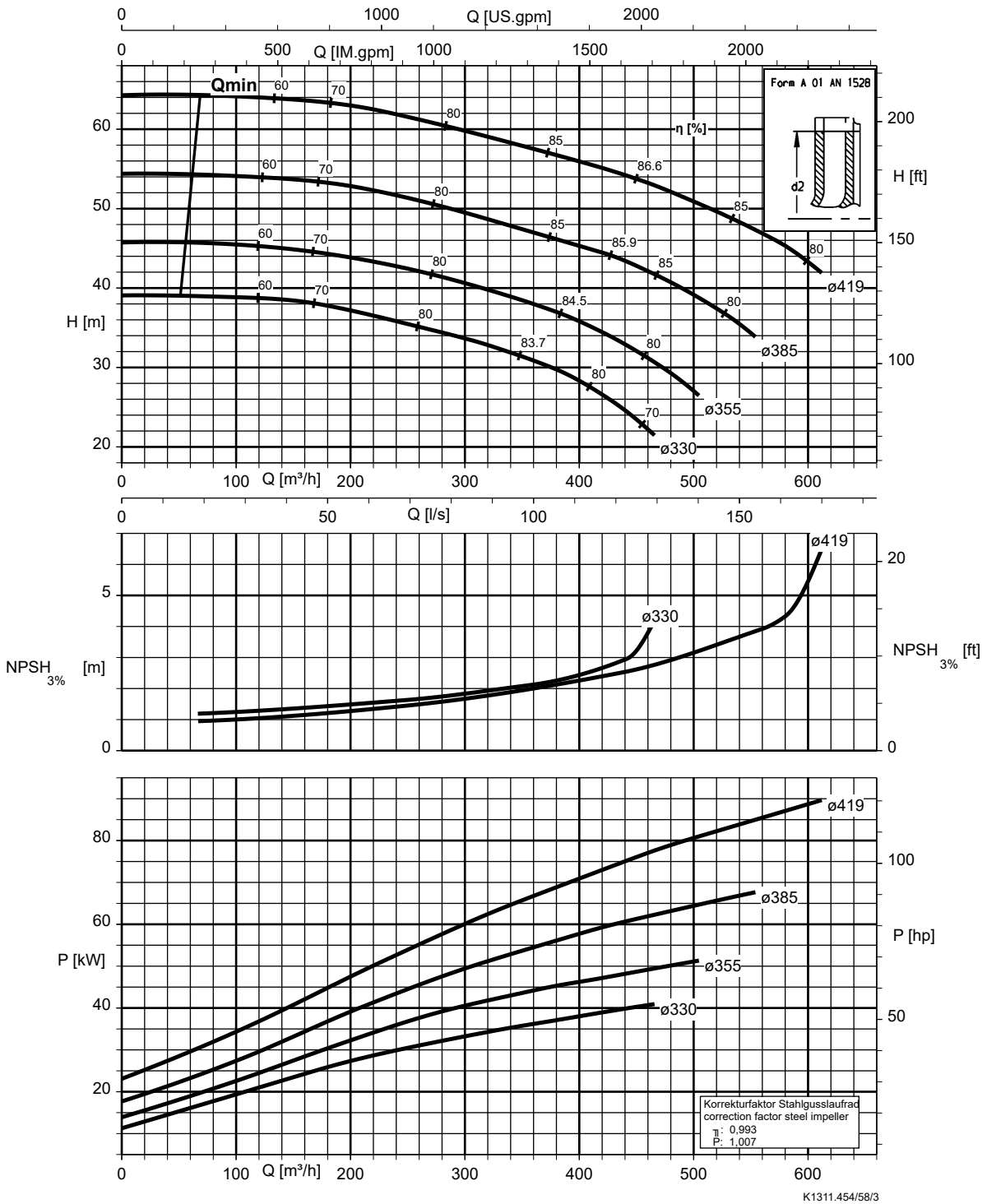

Vlet 200-150-510, n = 1450 rpm

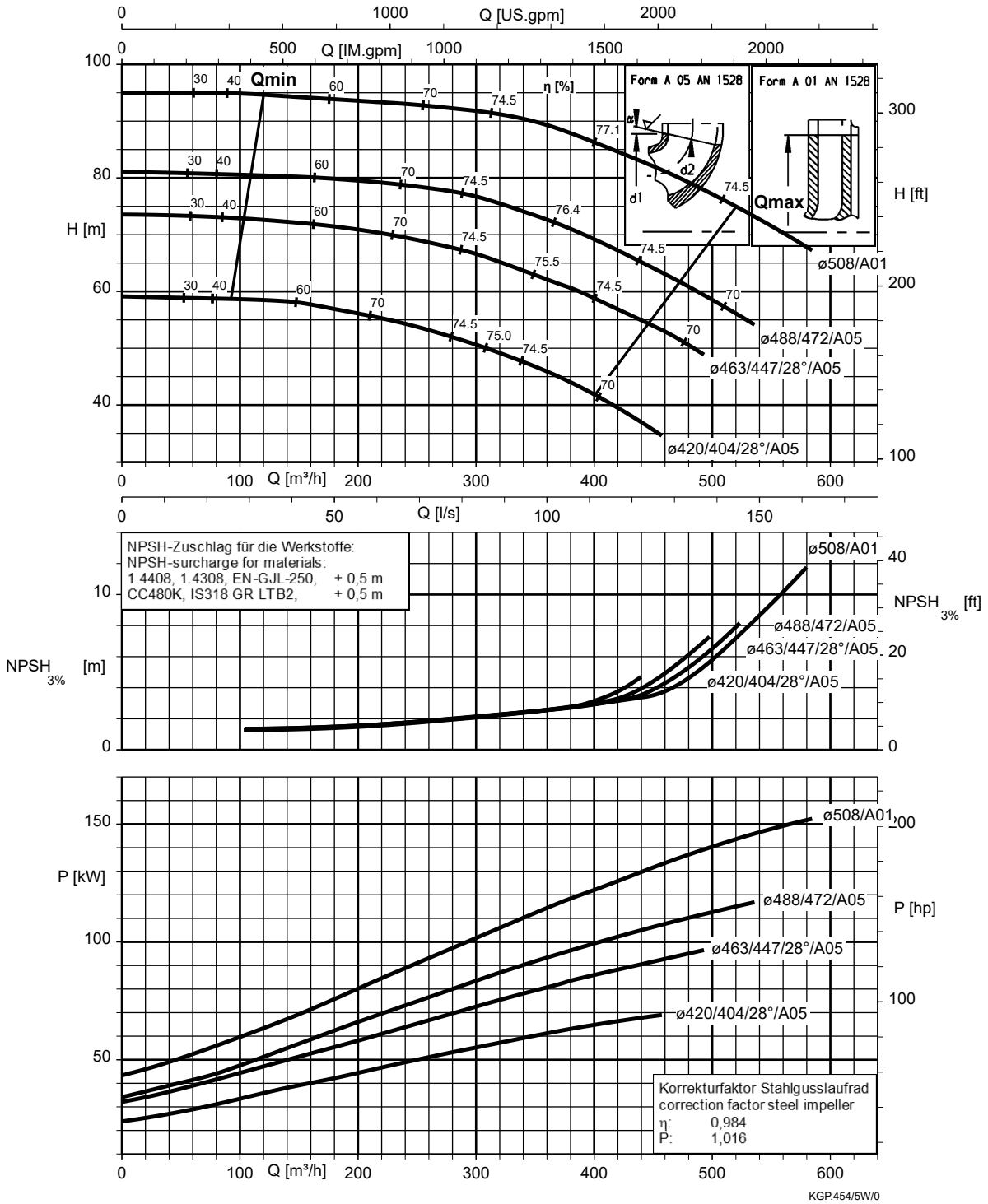

Vlet 200-200-250, n = 1450 rpm

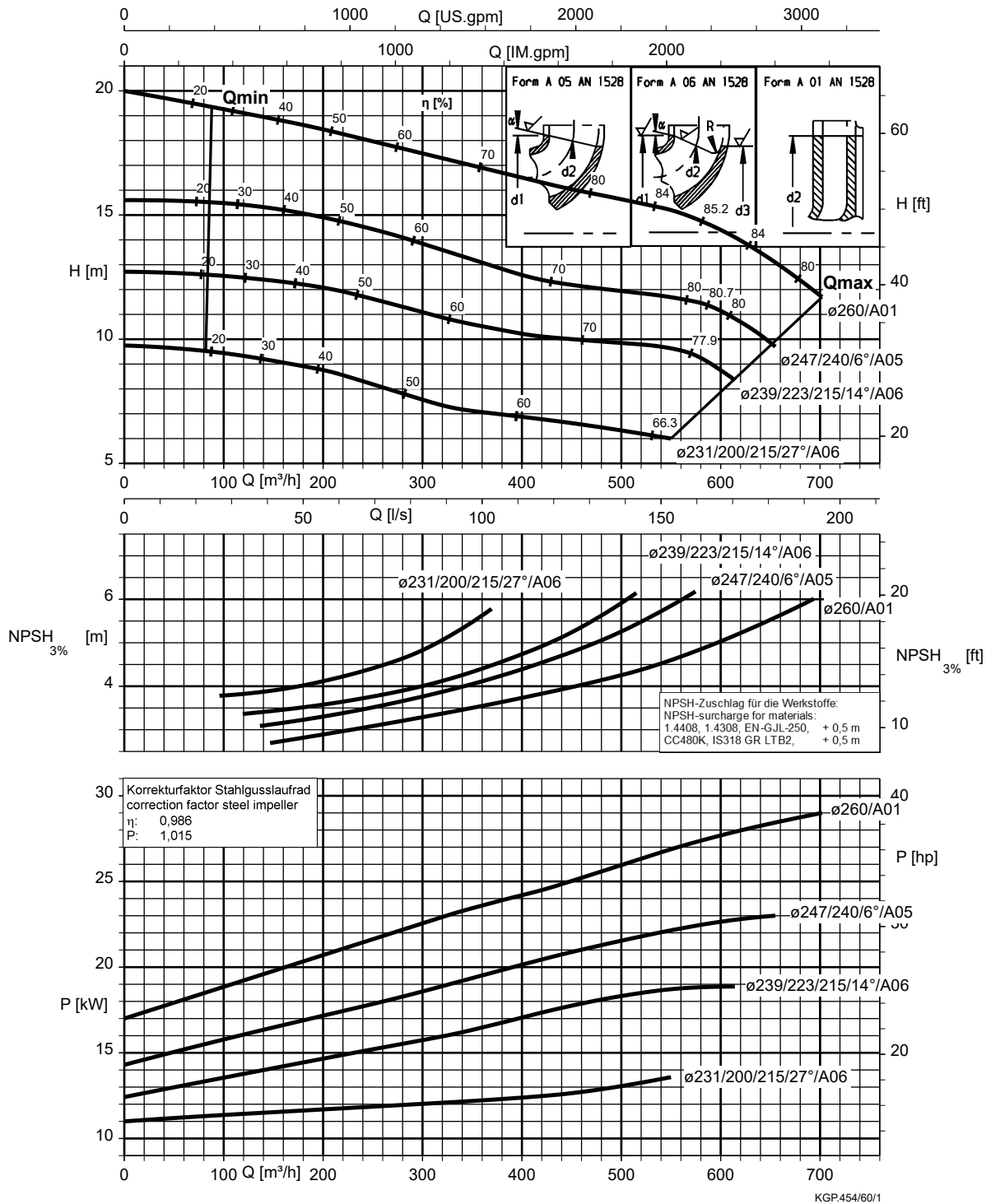

Vlet 250-200-275, n = 1450 rpm

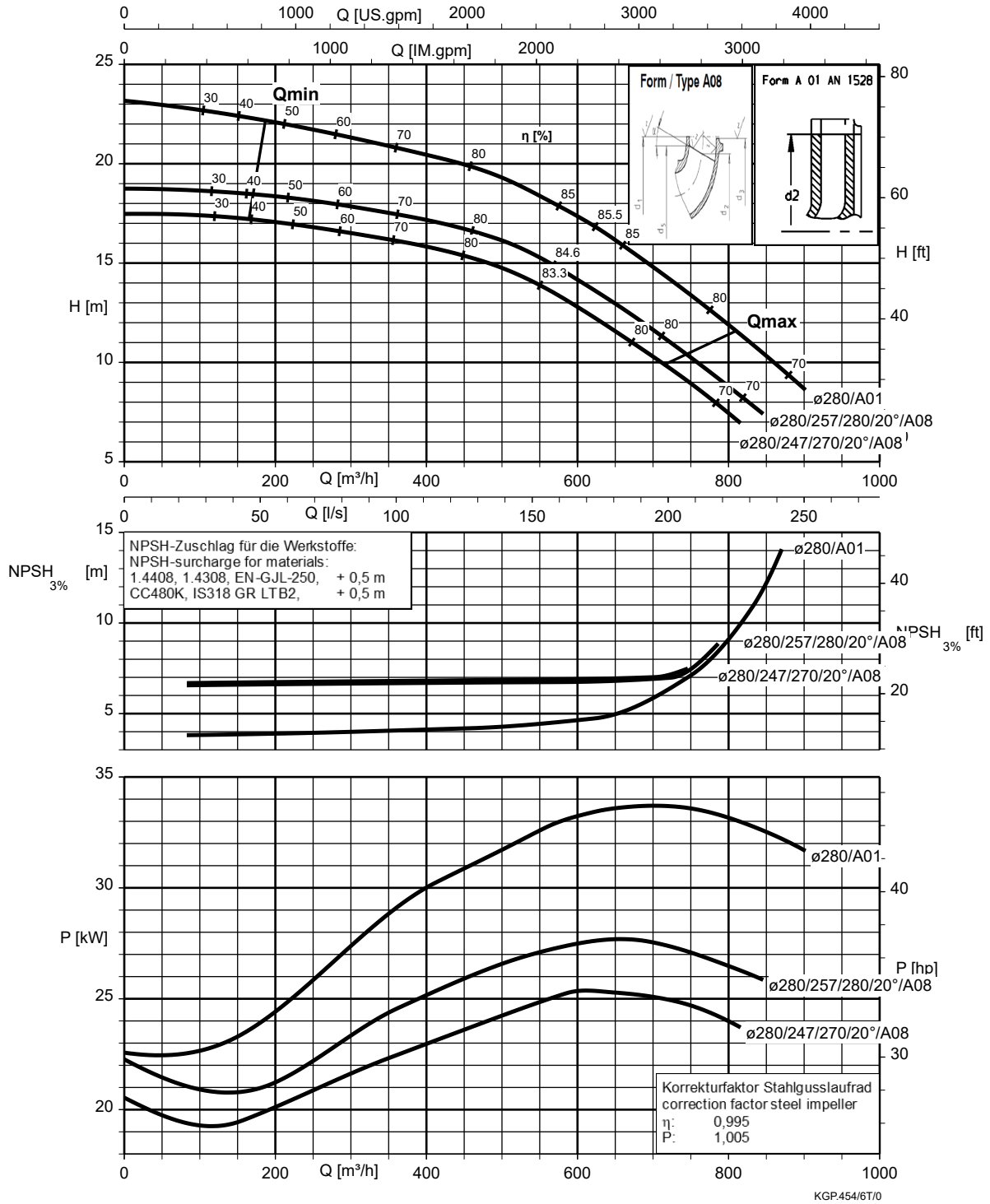

Vlet 250-200-320, n = 1450 rpm

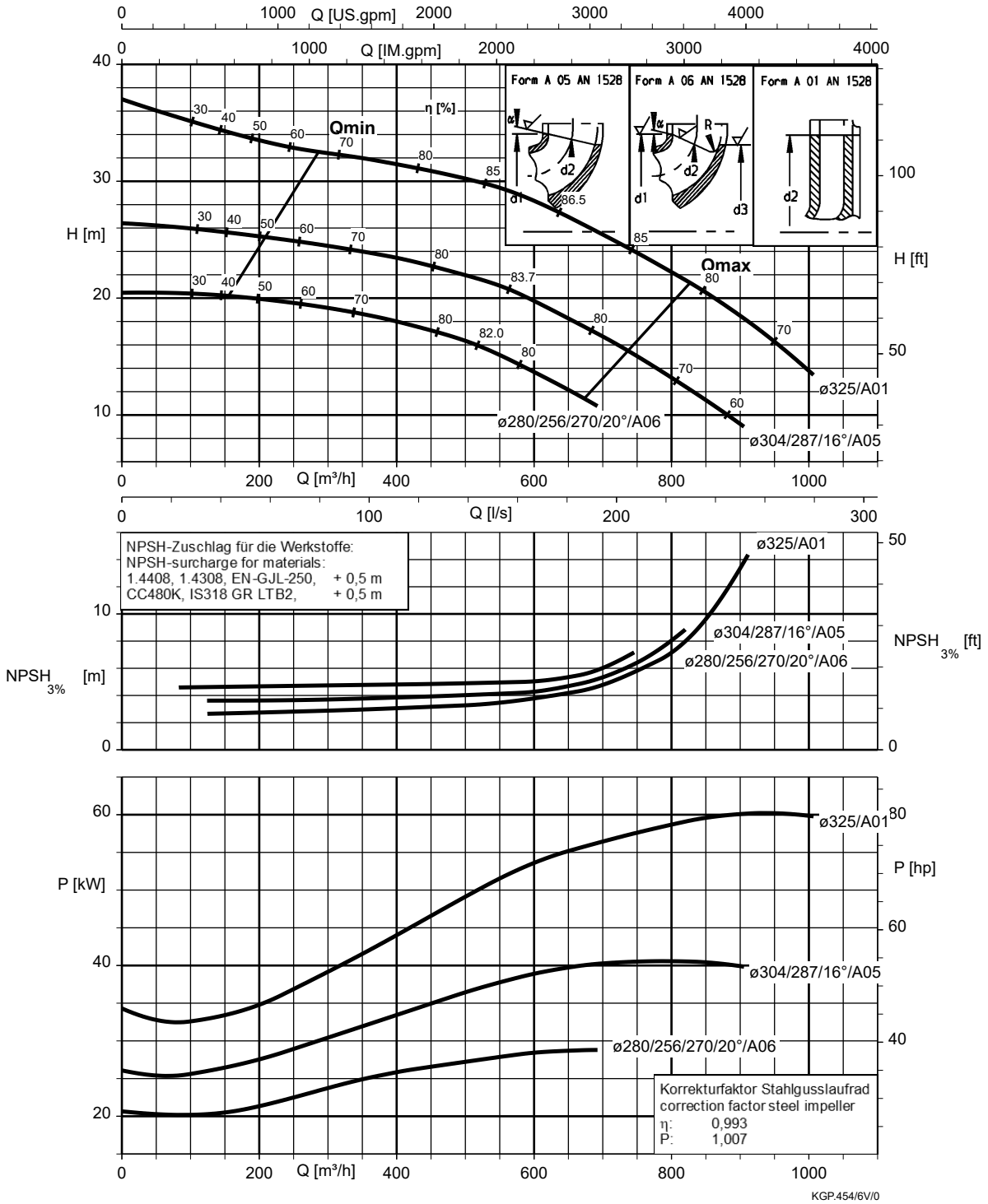

Vlet 250-200-375, n = 1450 rpm

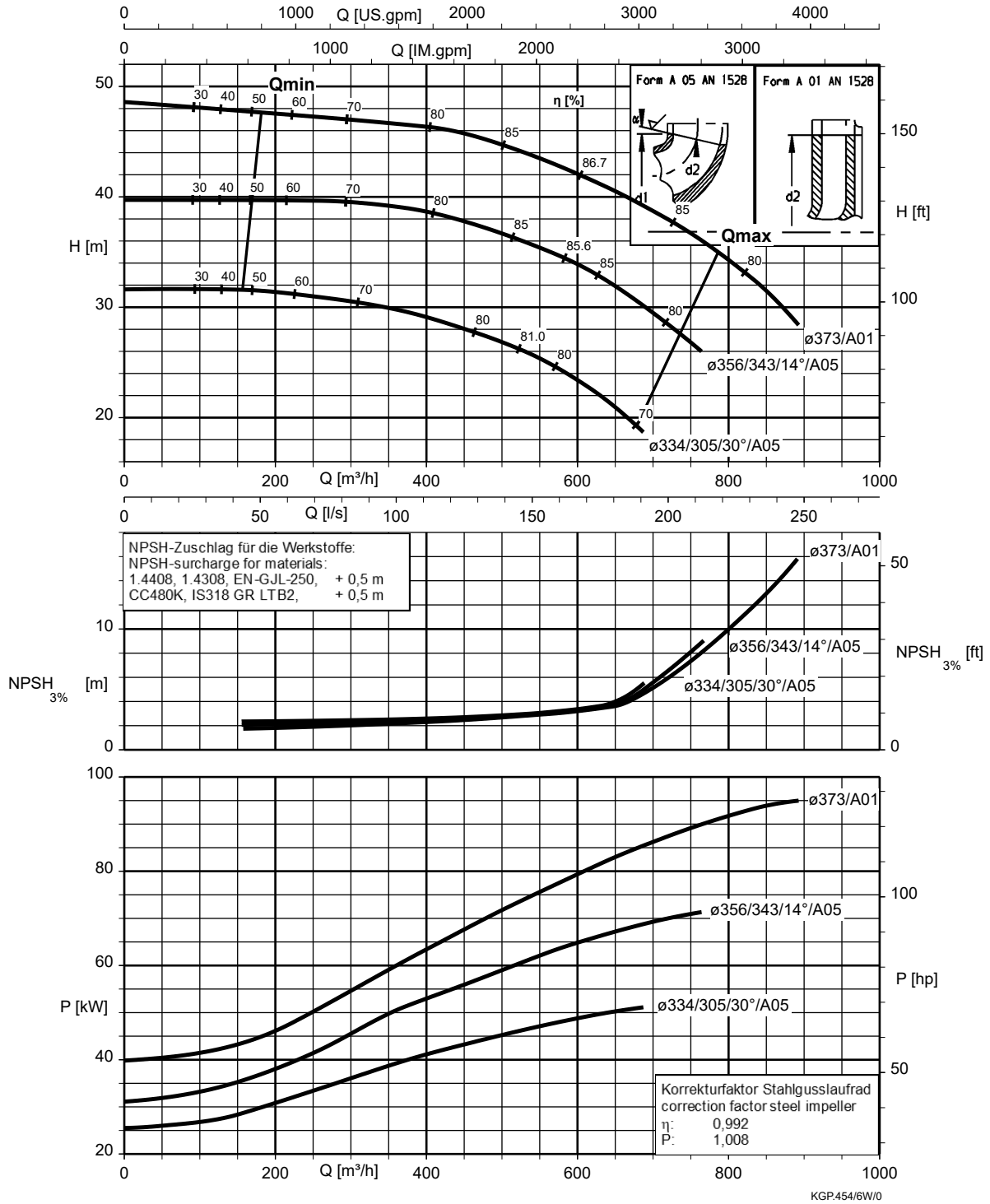

Vlet 250-200-435 , n = 1450 rpm

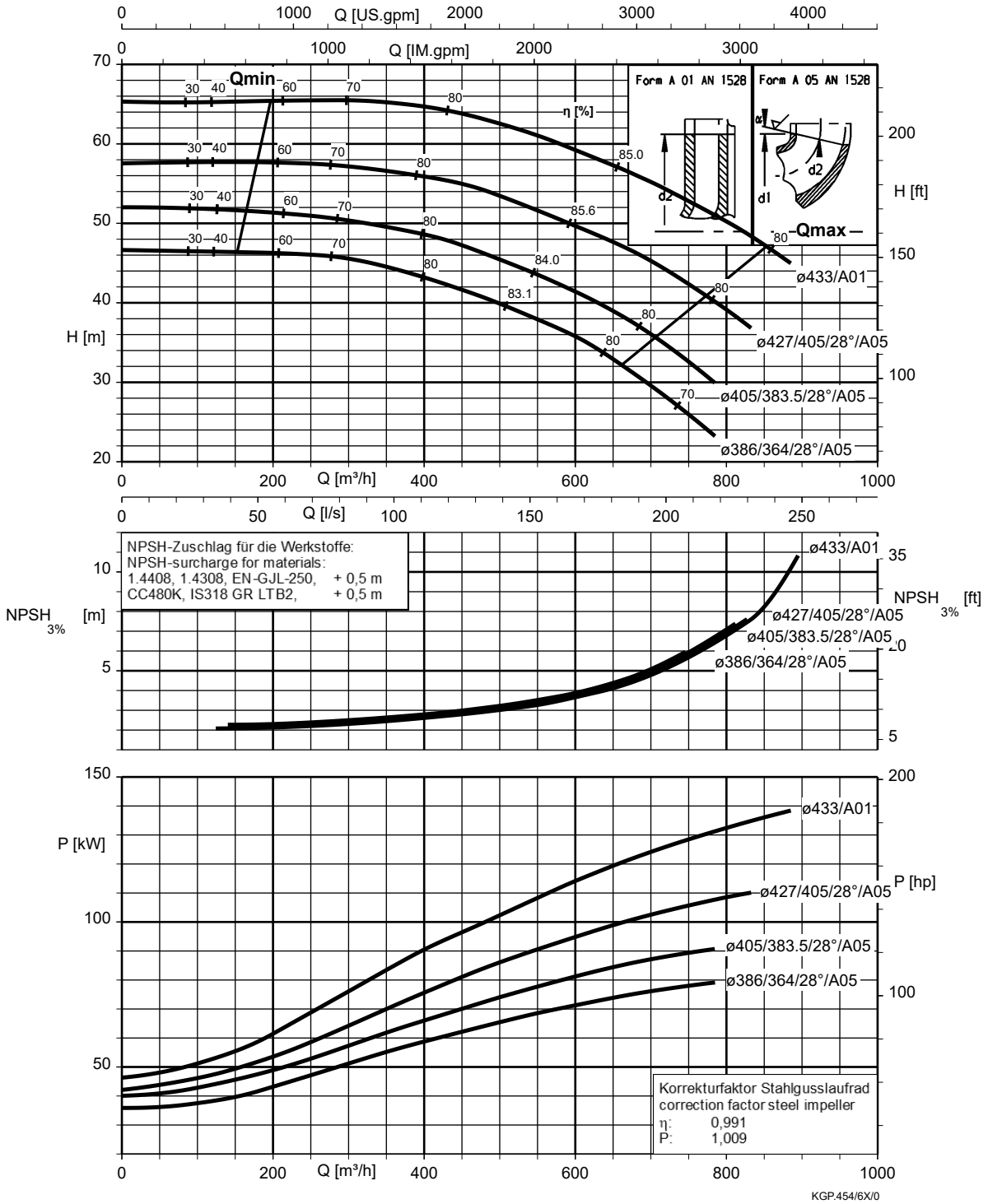

Vlet 300-250-295, n = 1450 rpm

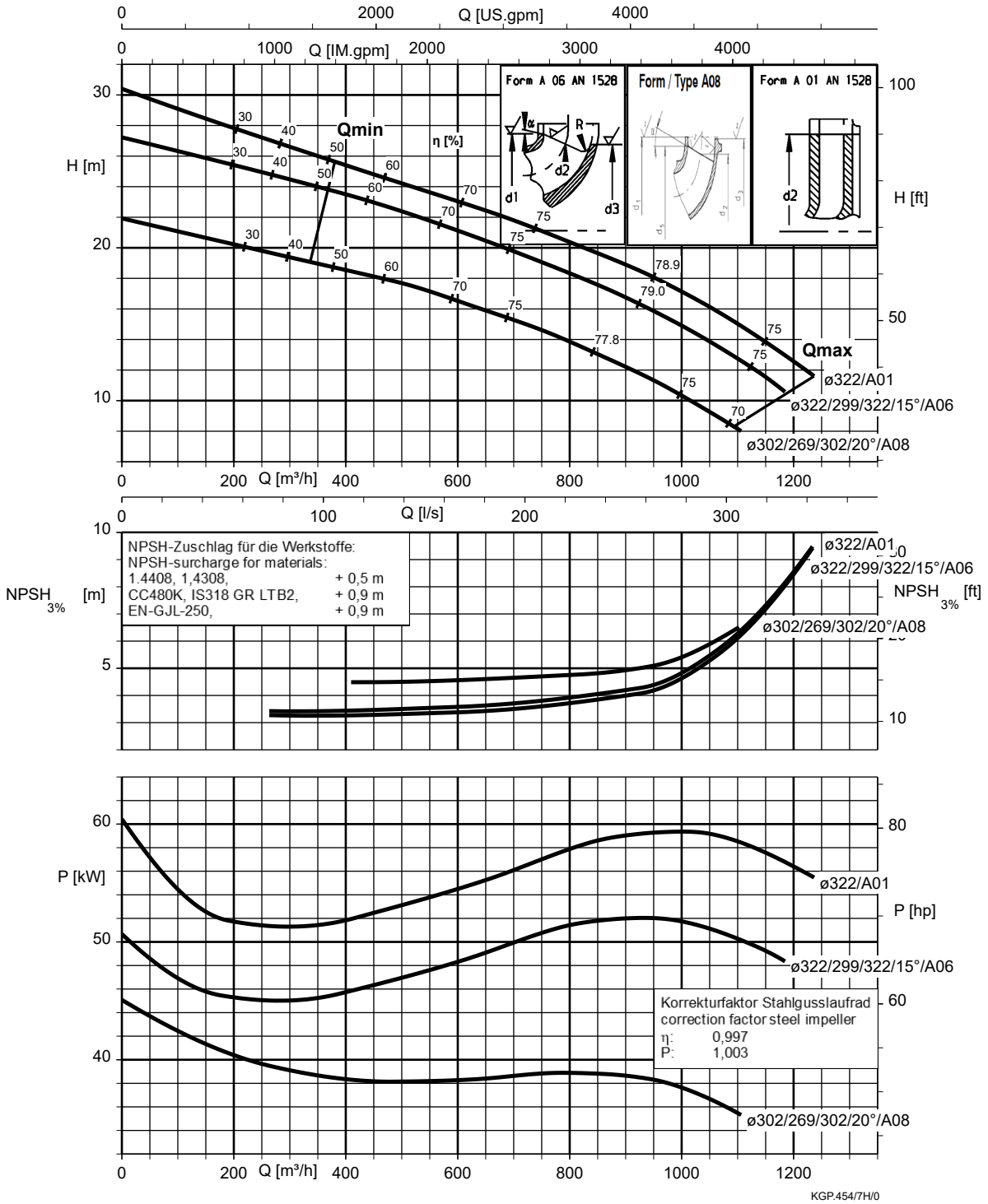

Vlet 300-250-295.1 , n = 1450 rpm

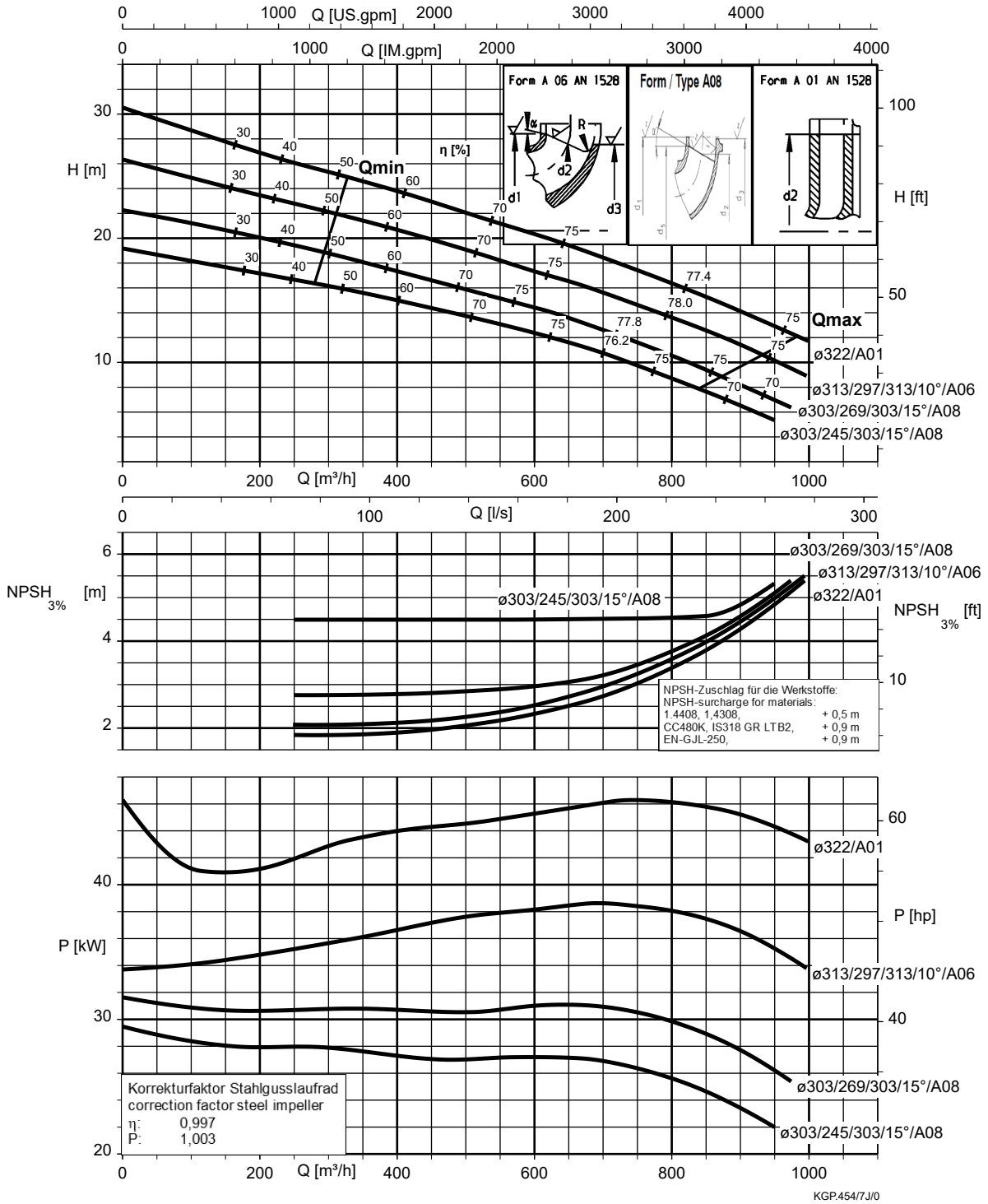

Vlet 300-250-320, n = 1450 rpm

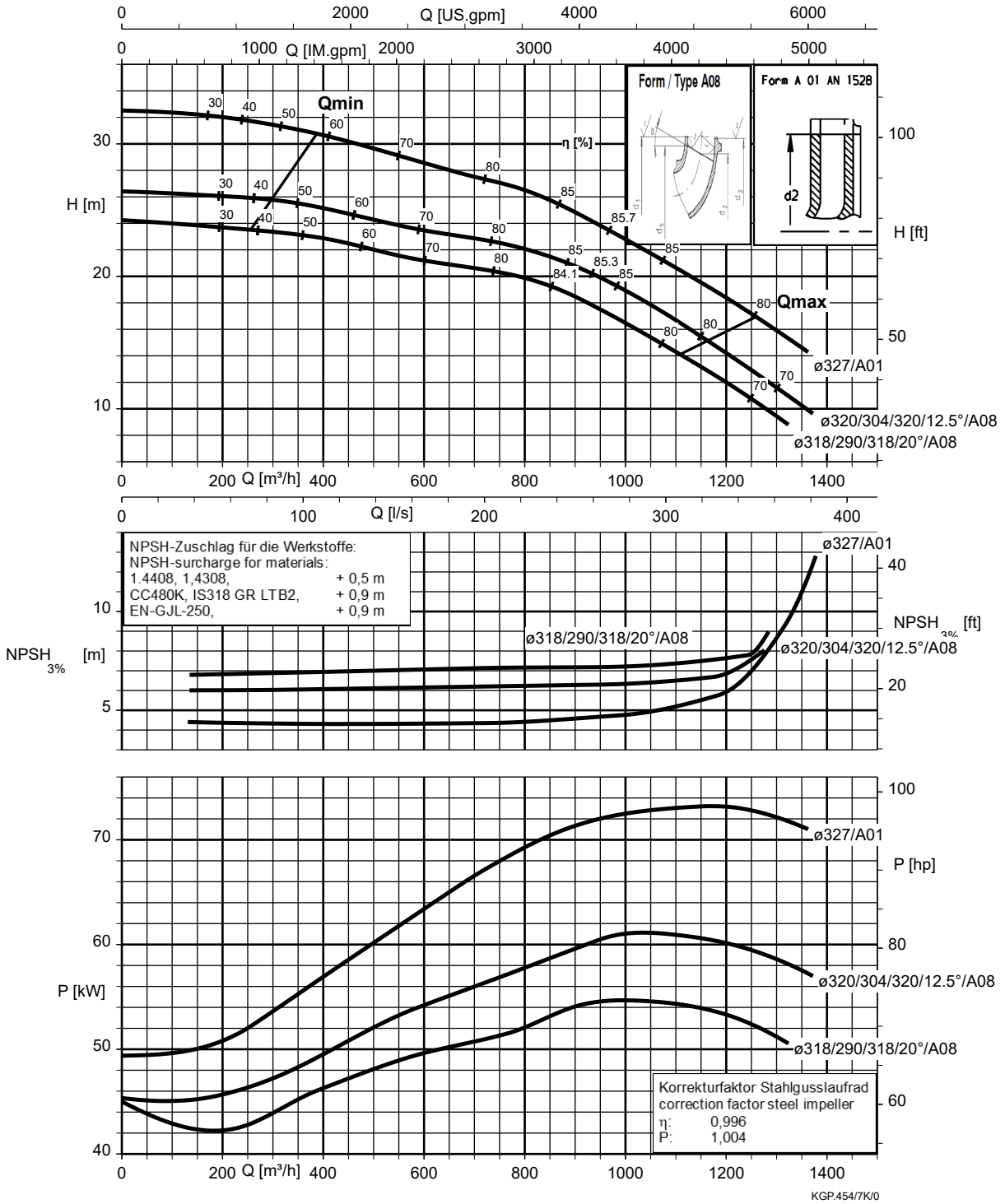

Vlet 300-250-375, n = 1450 rpm

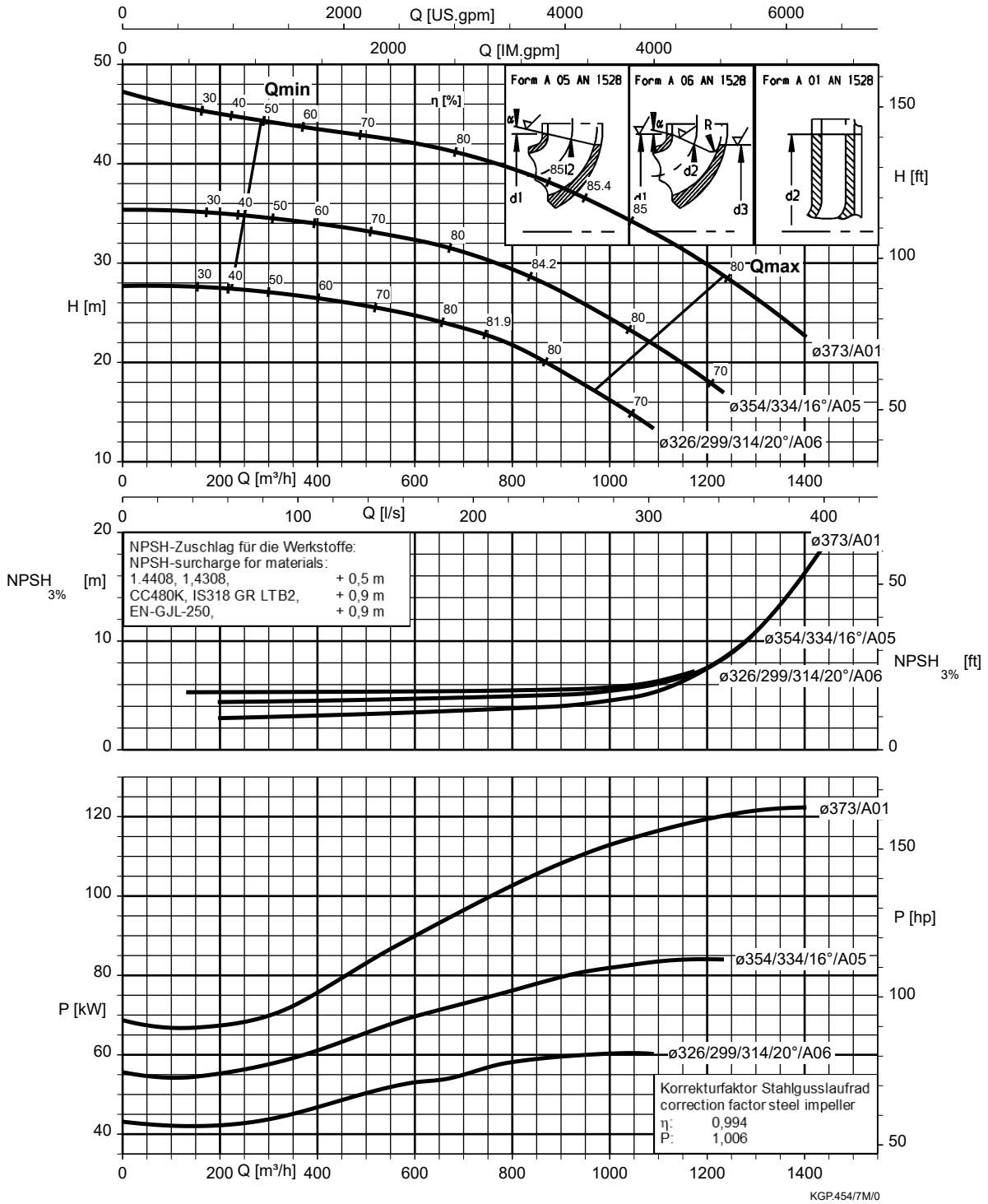

Vlet 300-250-435, n = 1450 rpm

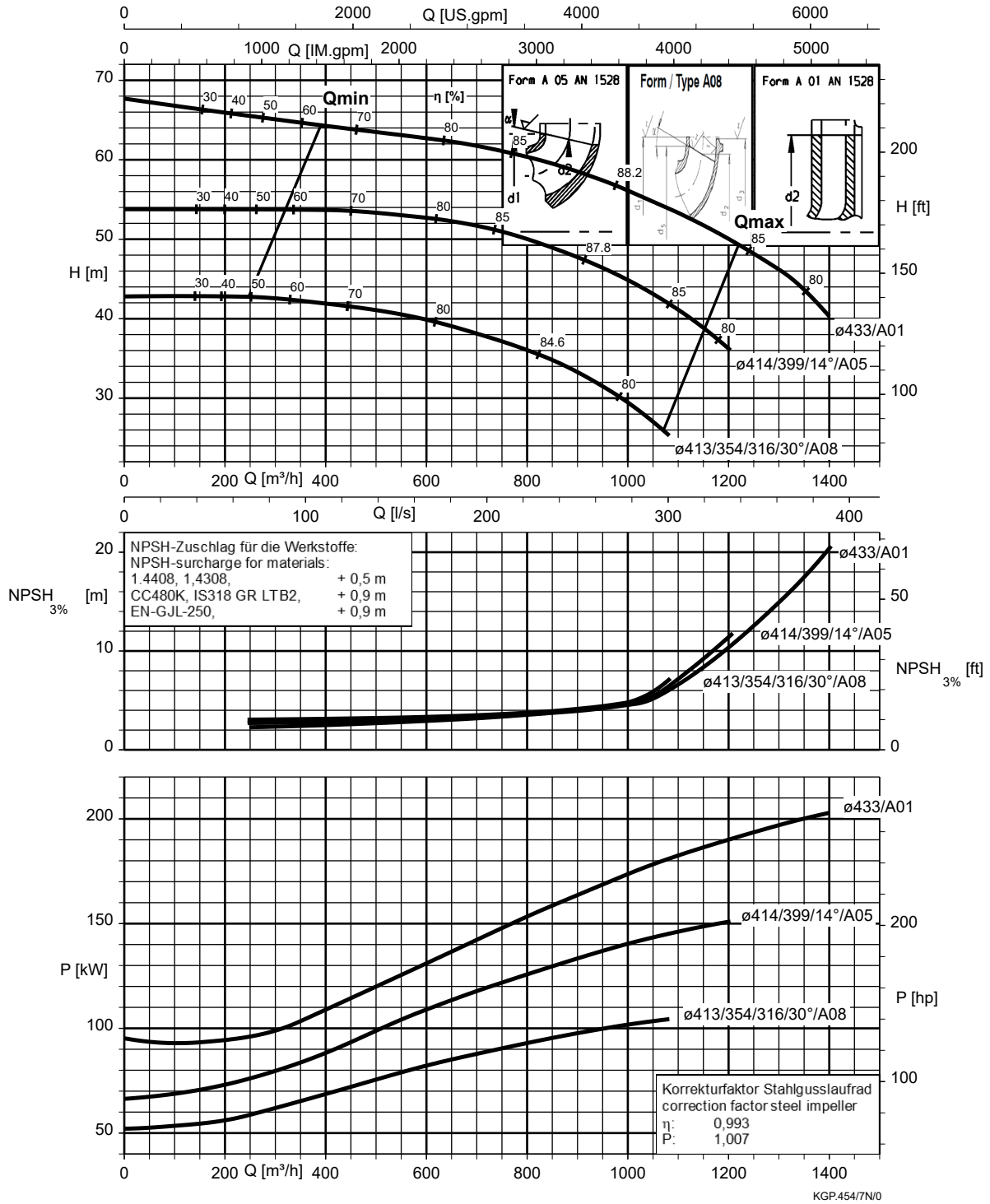

Vlet 300-250-510, n = 1450 rpm

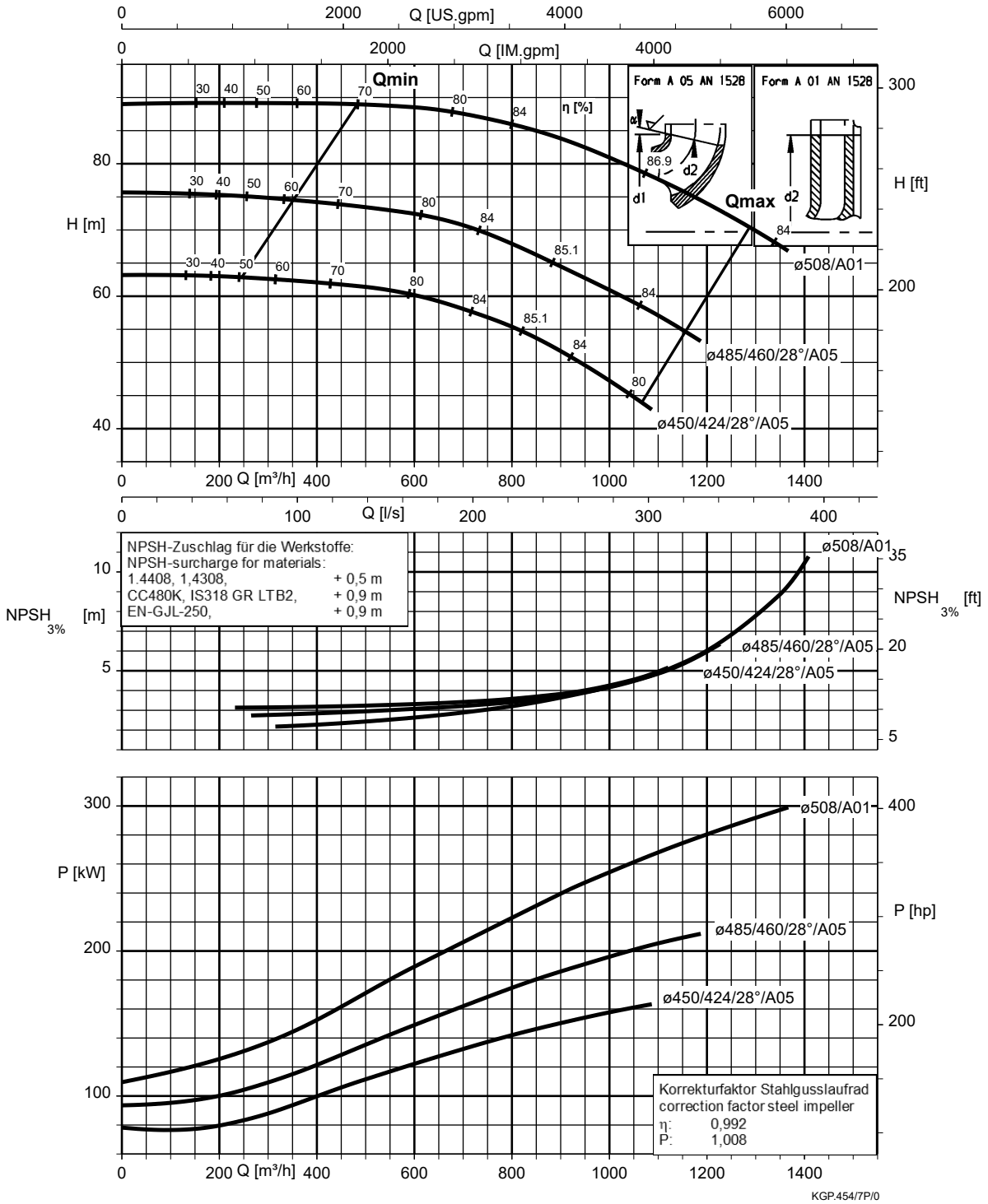

Vlet 350-300-350, n = 1450 rpm

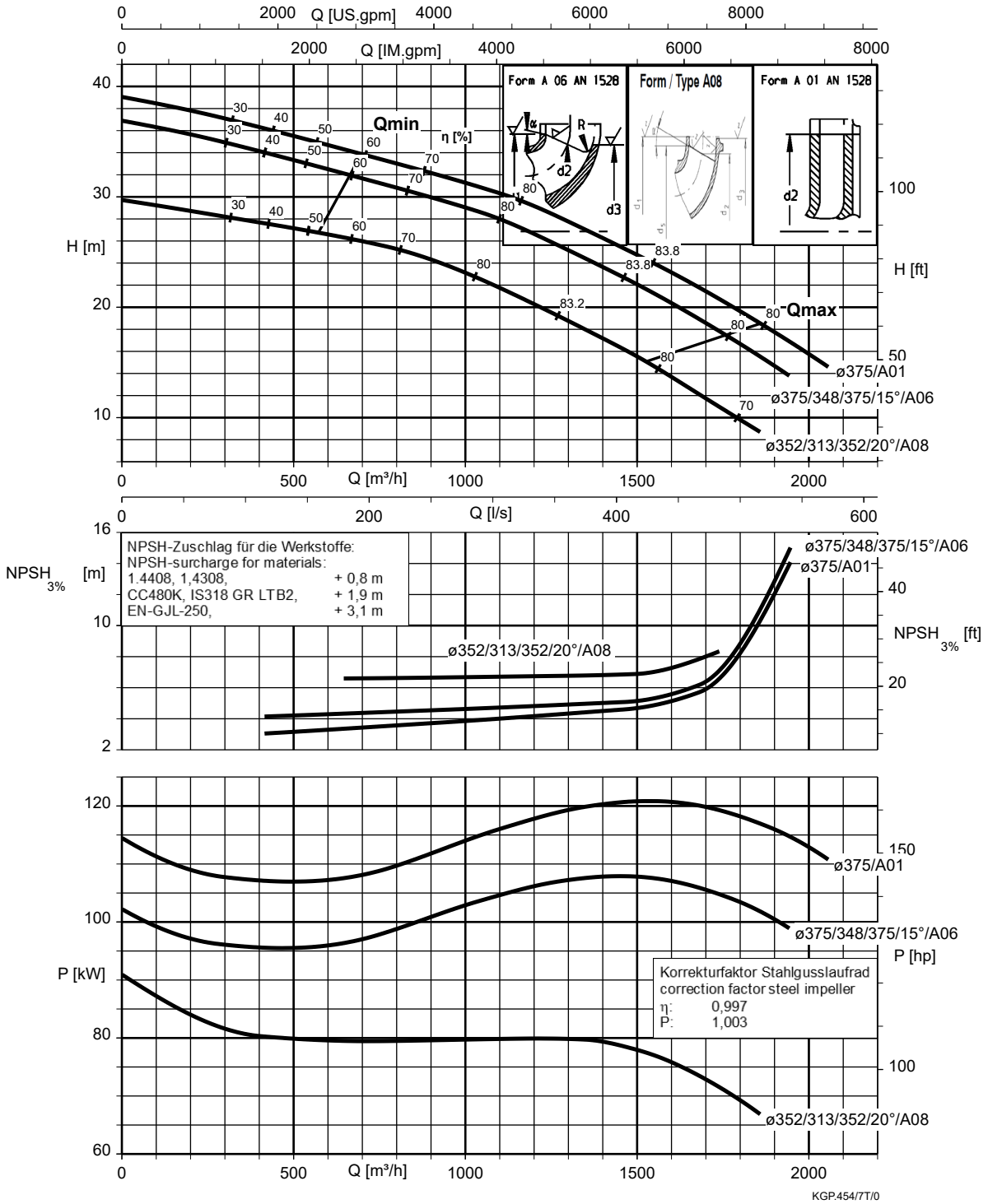

Vlet 350-300-350.1 , n = 1450 rpm

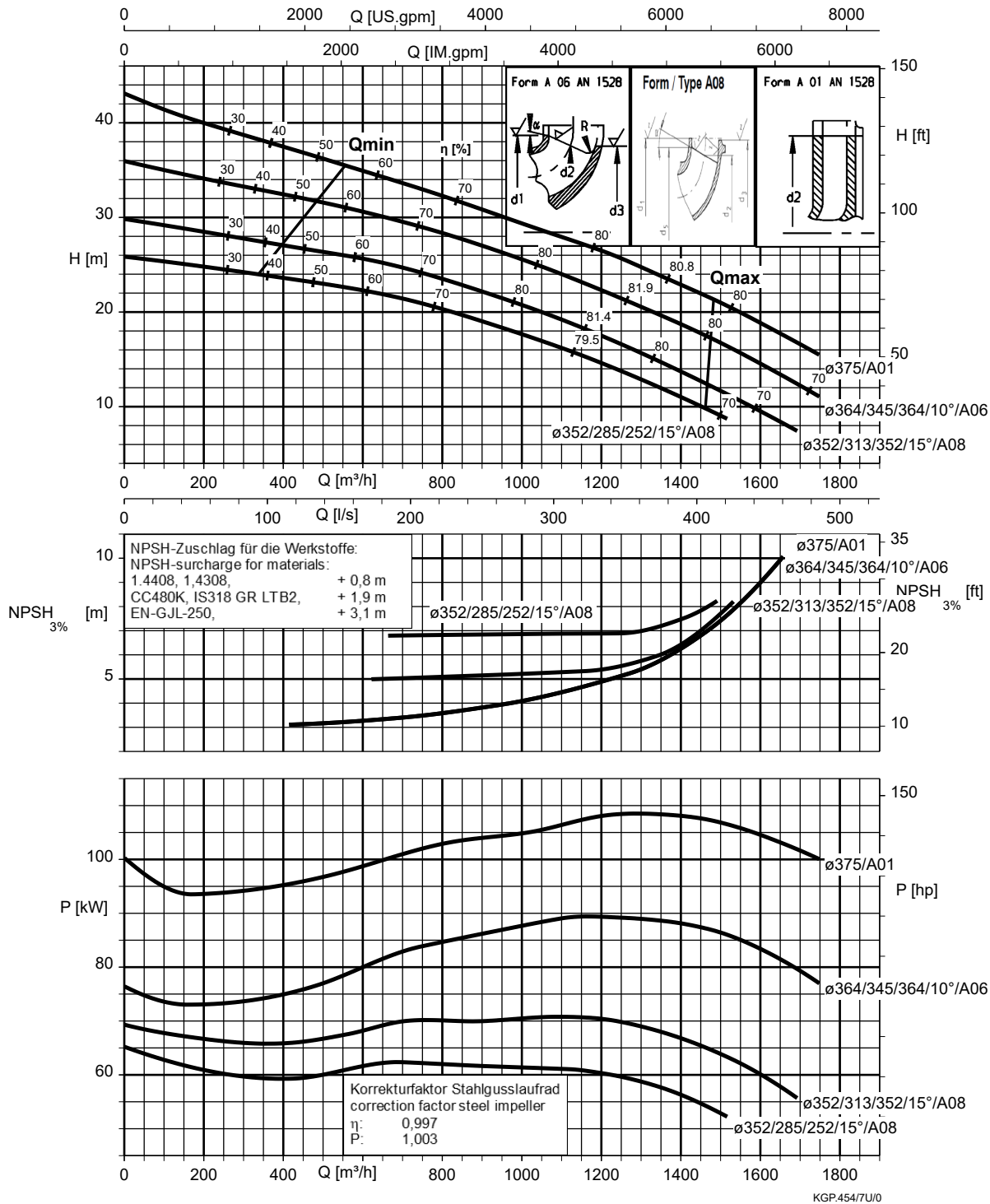

Vlet 350-300-375, n = 1450 rpm

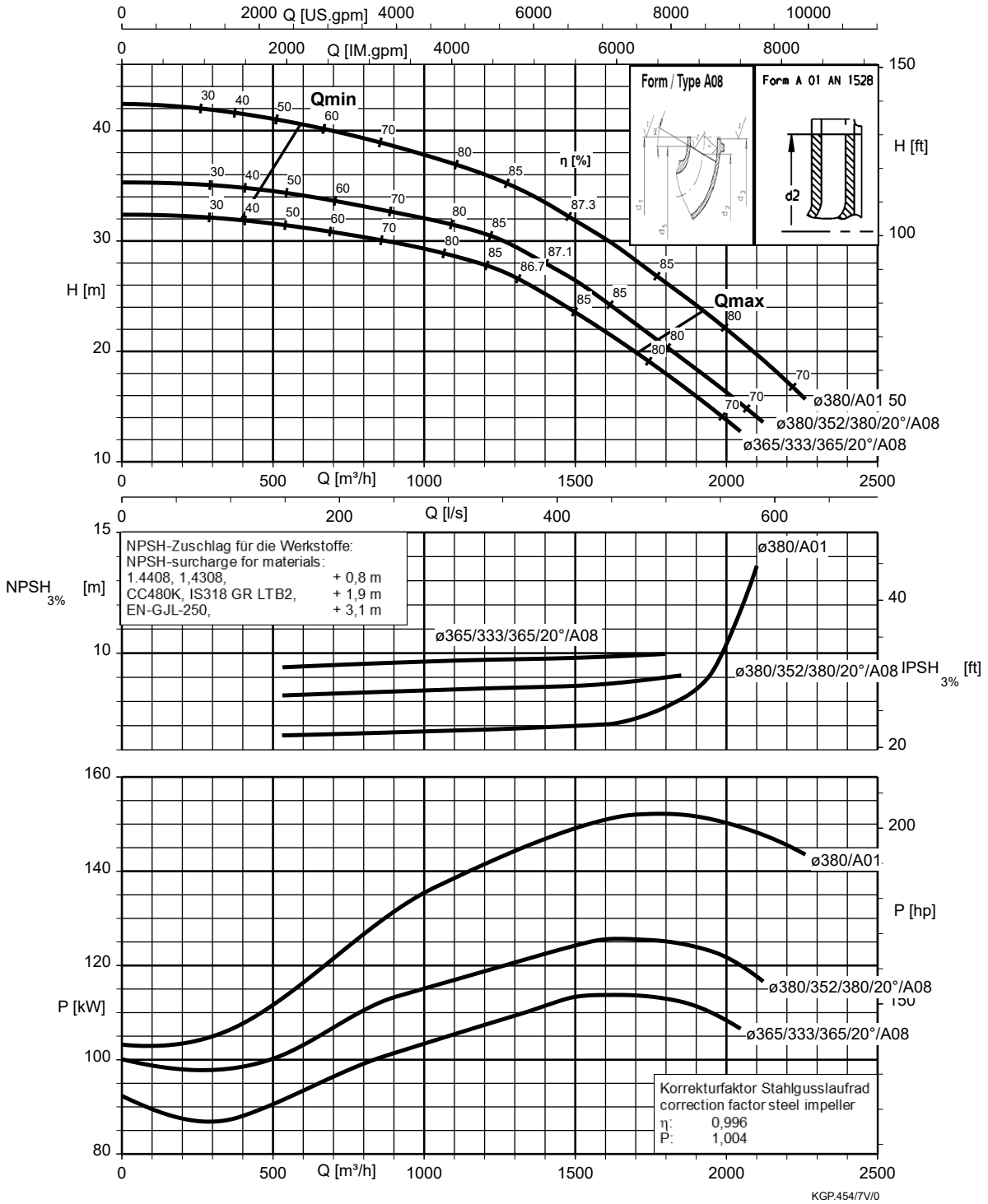

Vlet 350-300-435, n = 1450 rpm

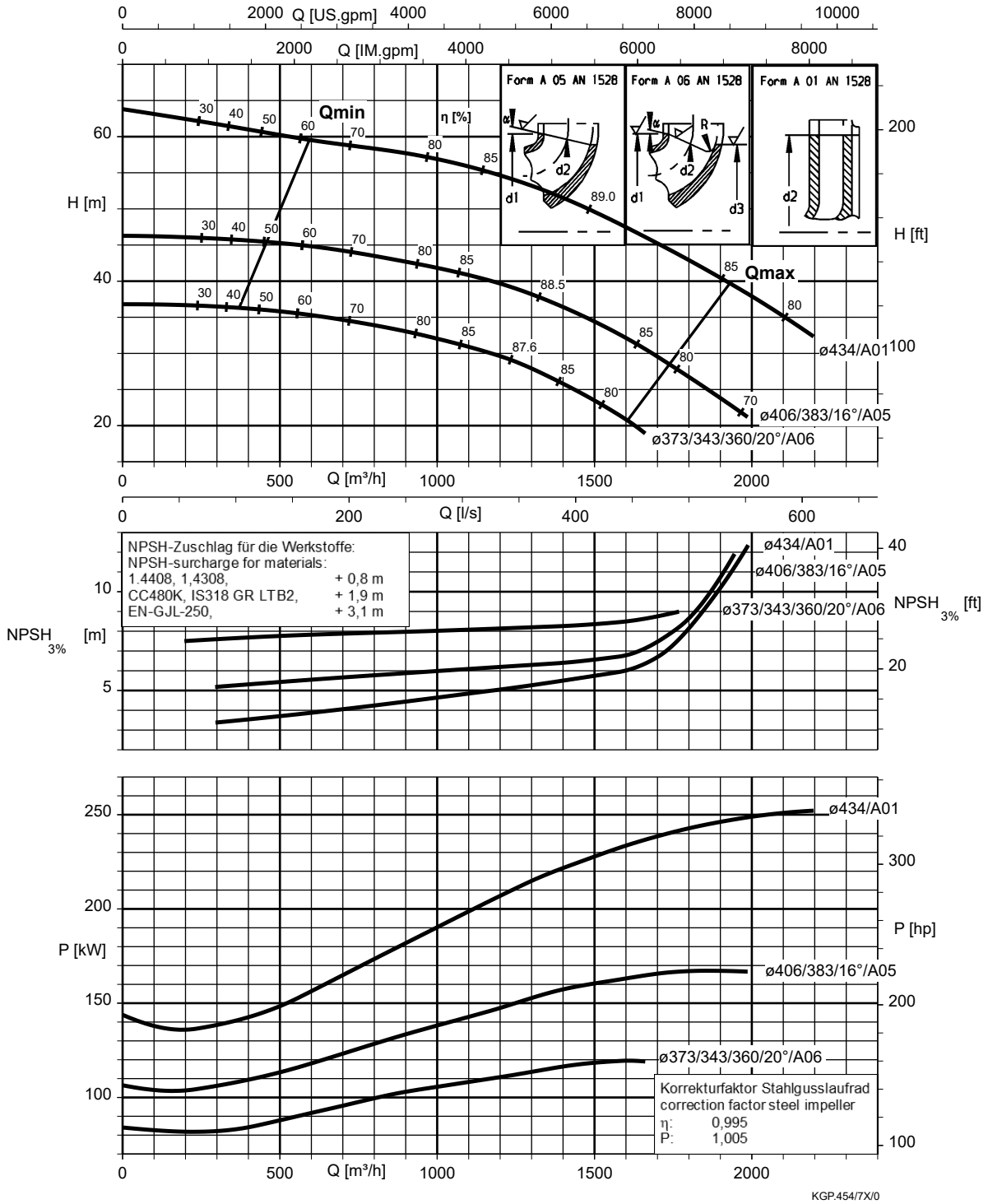

Vlet 350-300-510, n = 1450 rpm

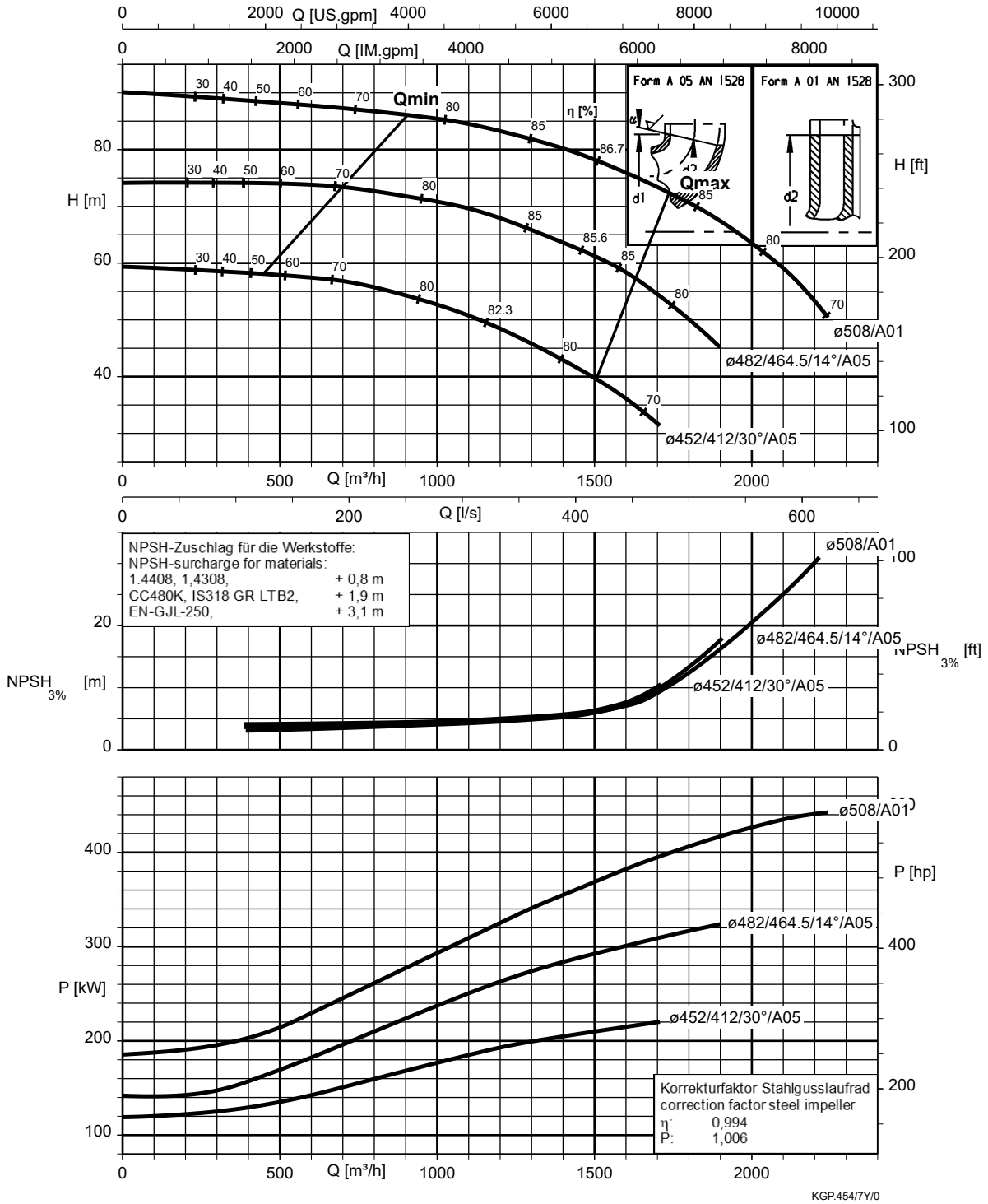

n = 960 rpm

Vlet 040-025-160, n = 960 rpm

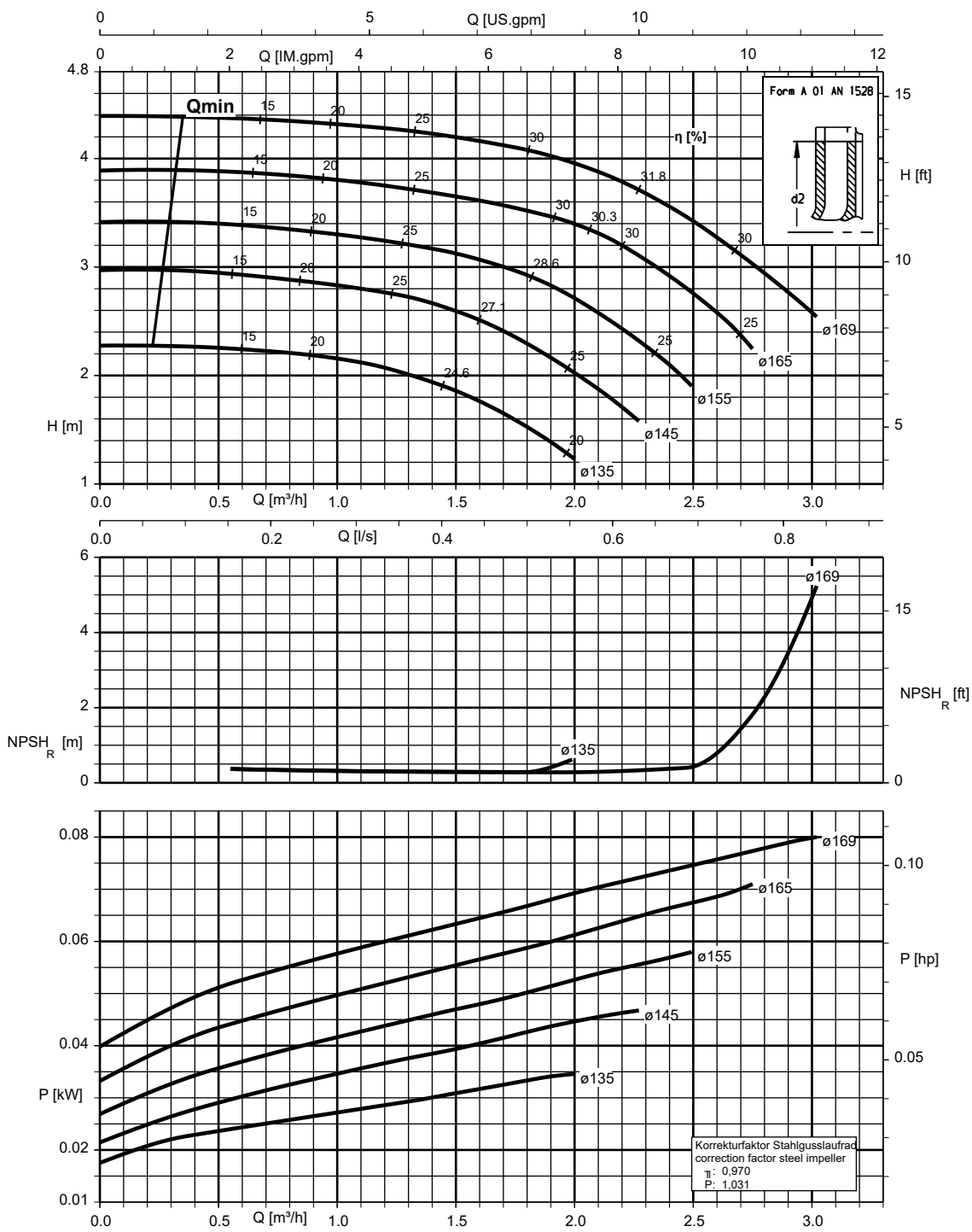

Vlet 040-025-200, n = 960 rpm

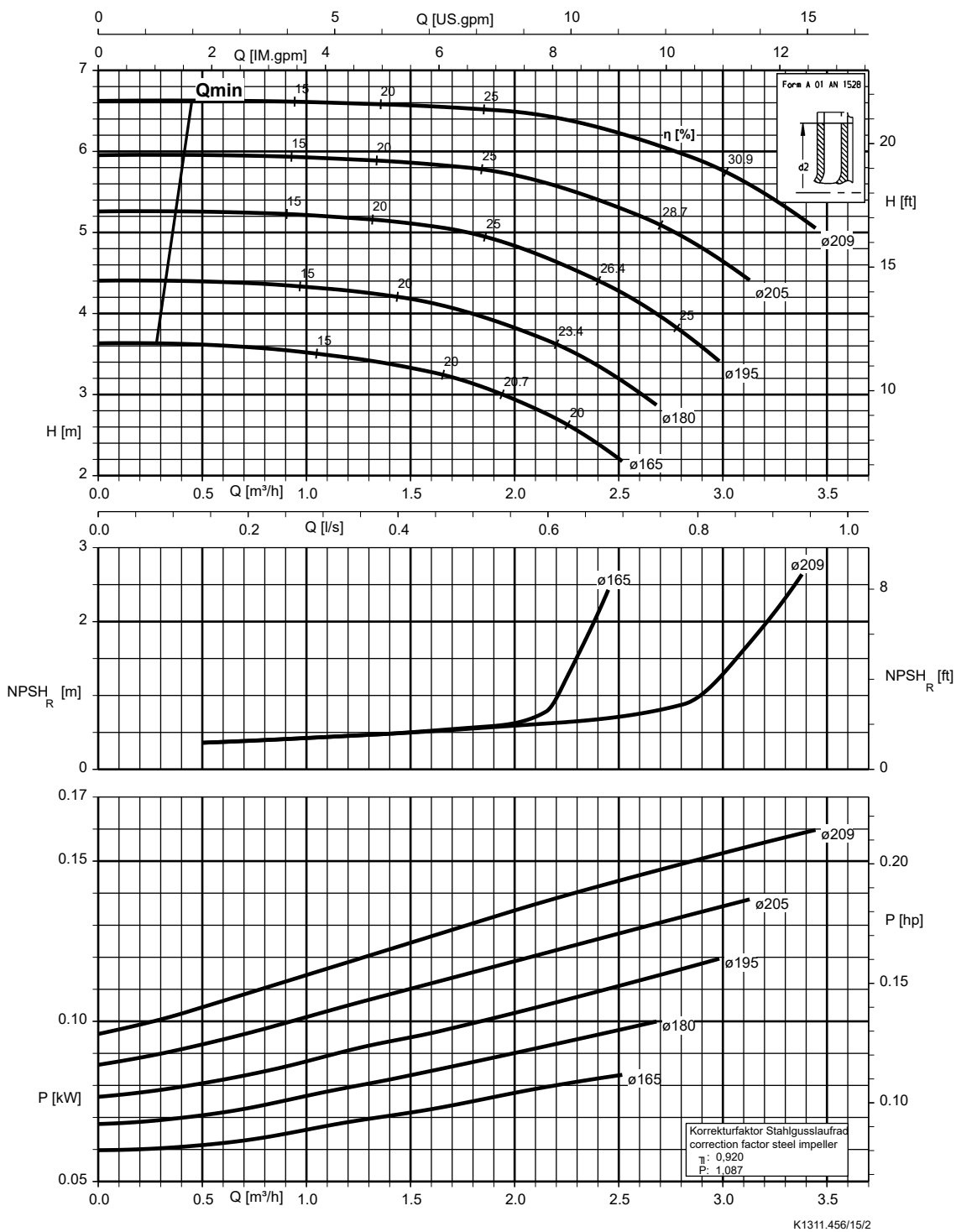

Vlet 050-032-125.1, n = 960 rpm

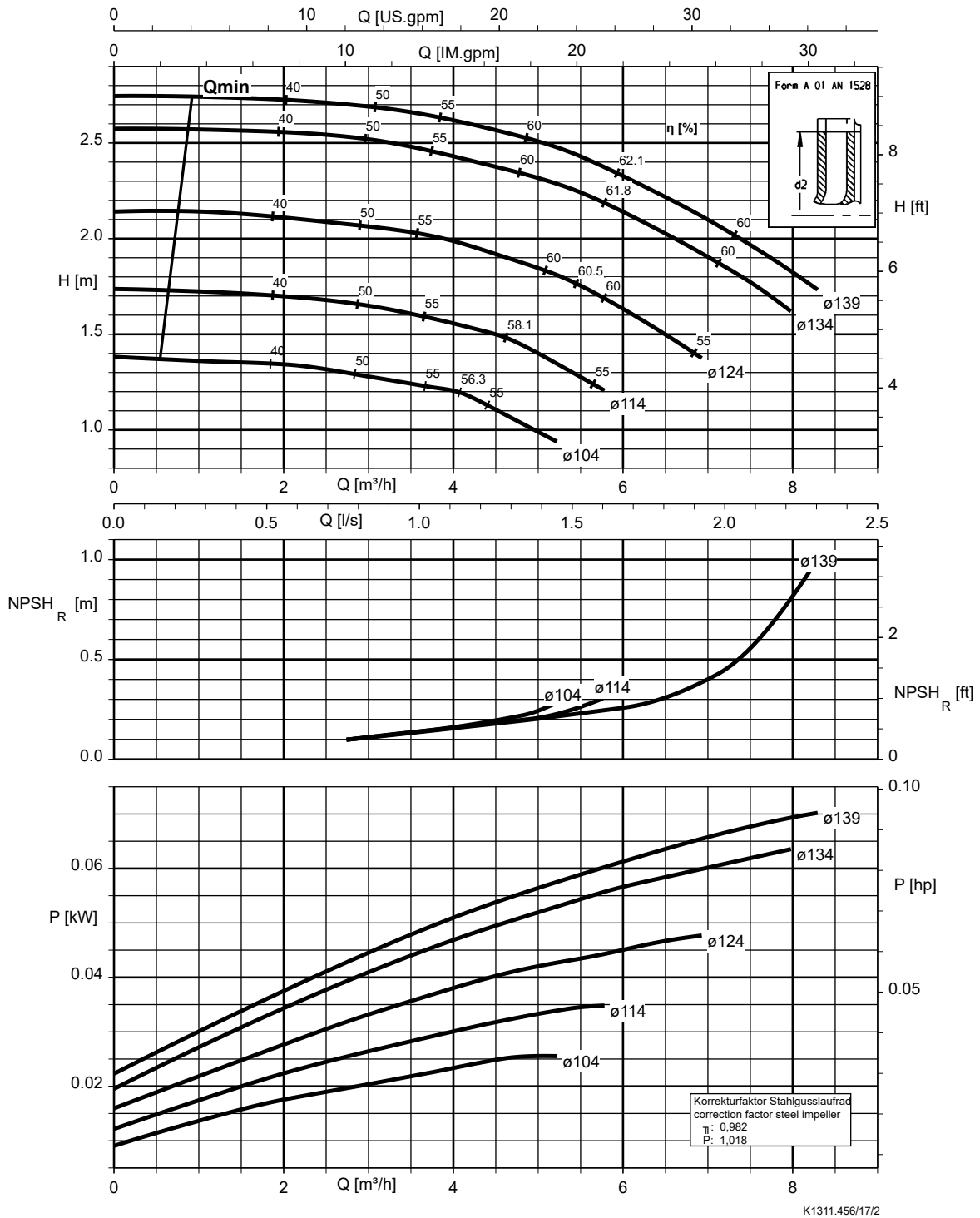

Vlet 050-032-160.1, n = 960 rpm

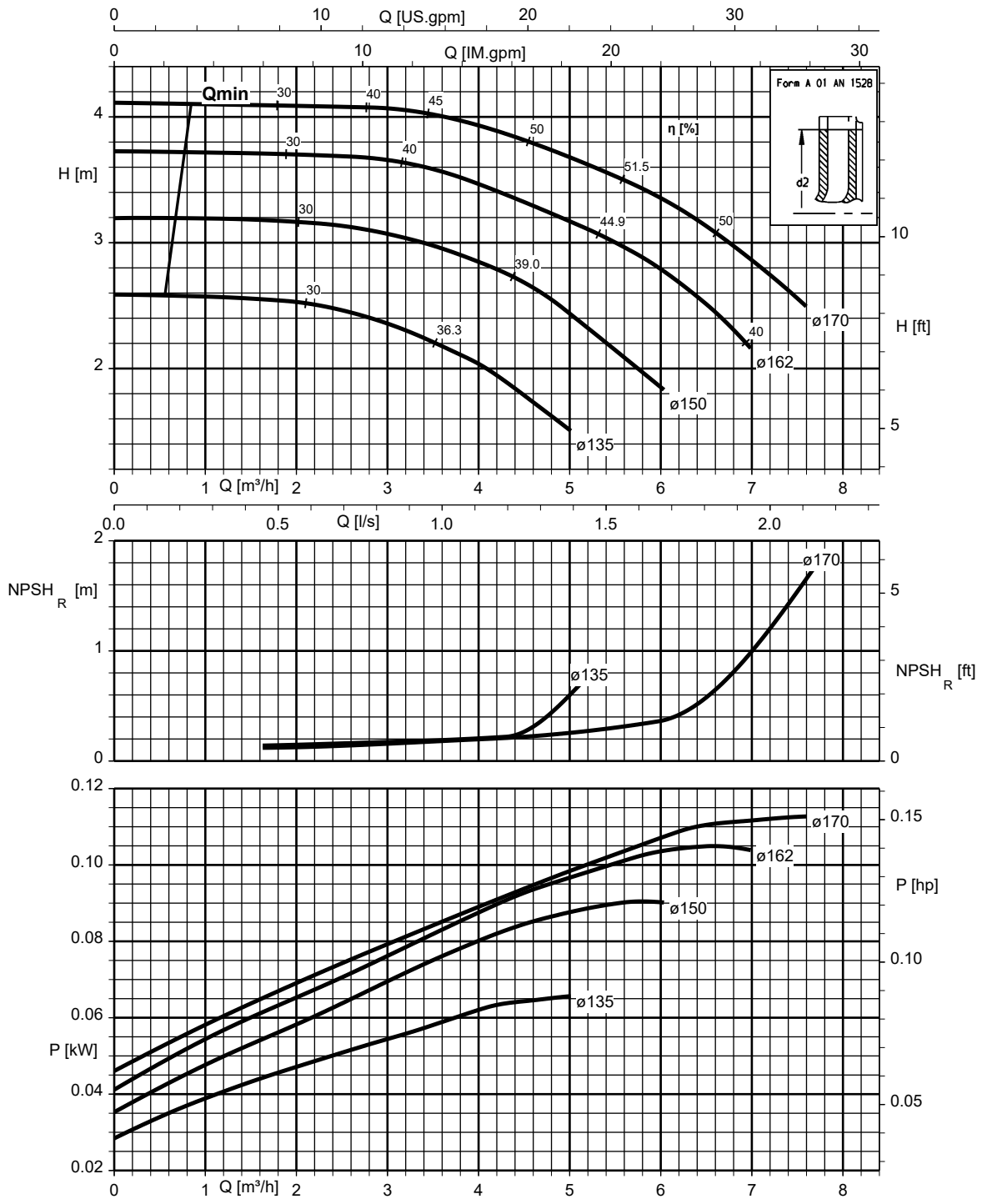

K1311.456/18/2

Vlet 050-032-200.1, n = 960 rpm

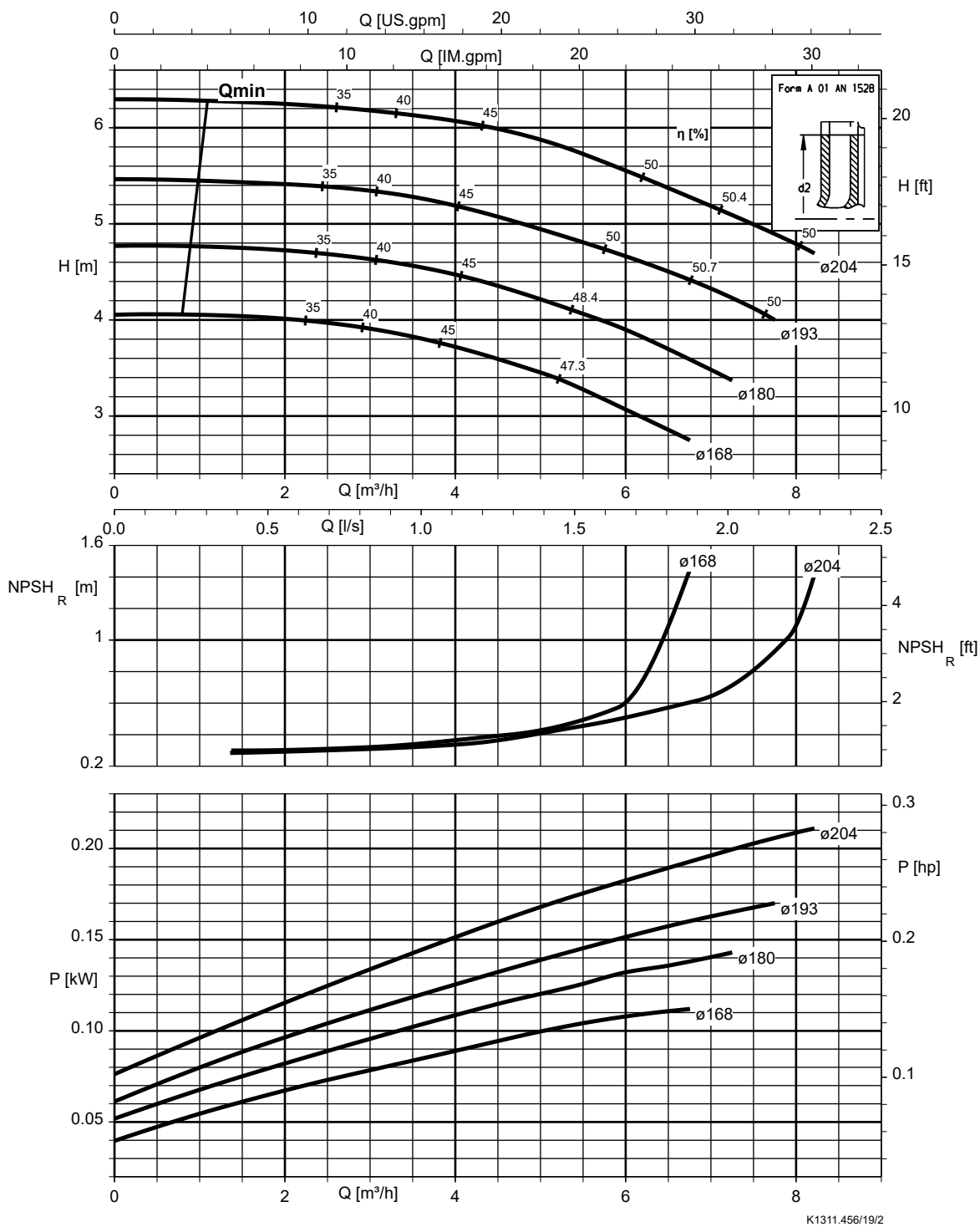

Vlet 050-032-250.1, n = 960 rpm

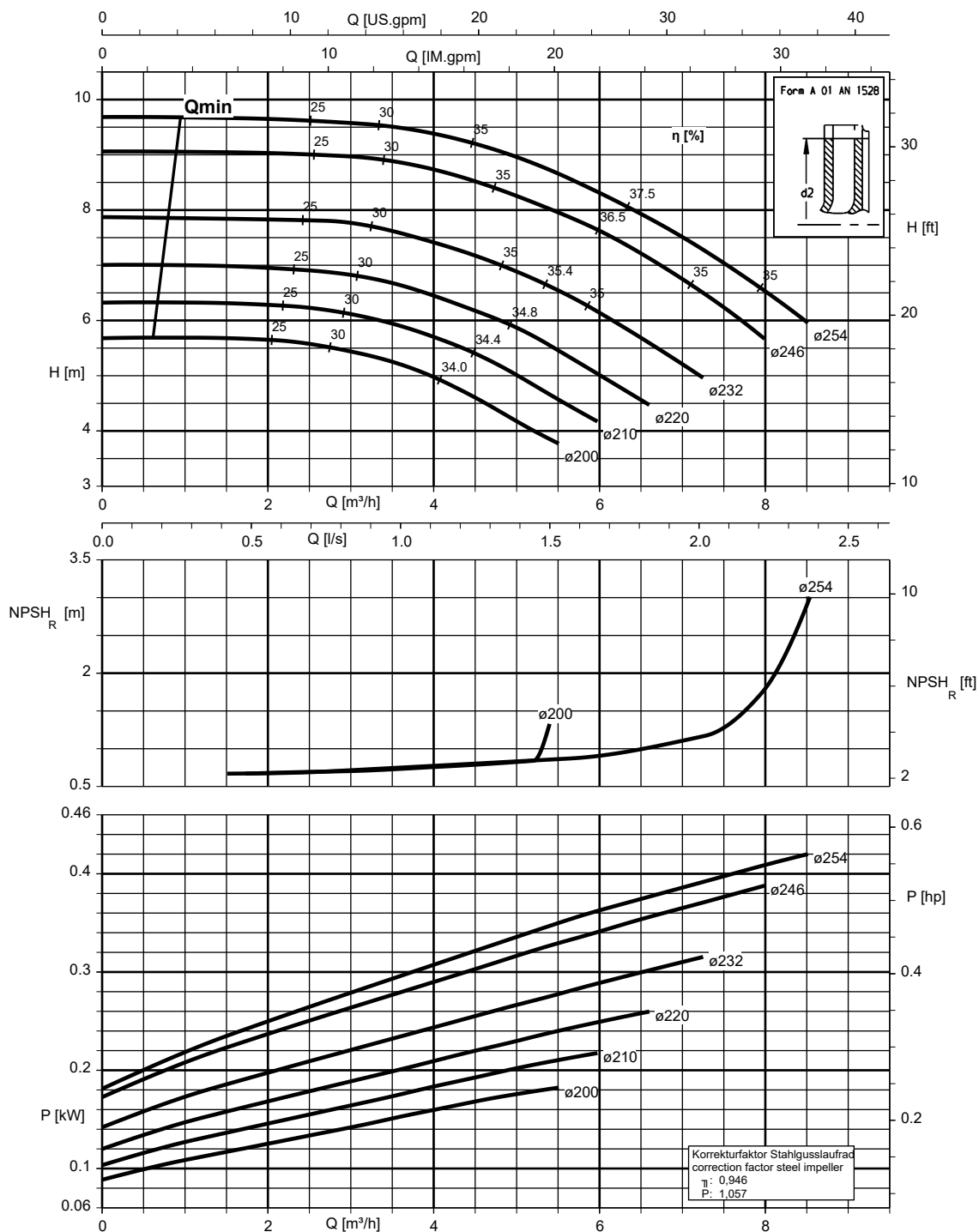

K1311.456/20/2

Vlet 050-032-125, n = 960 rpm

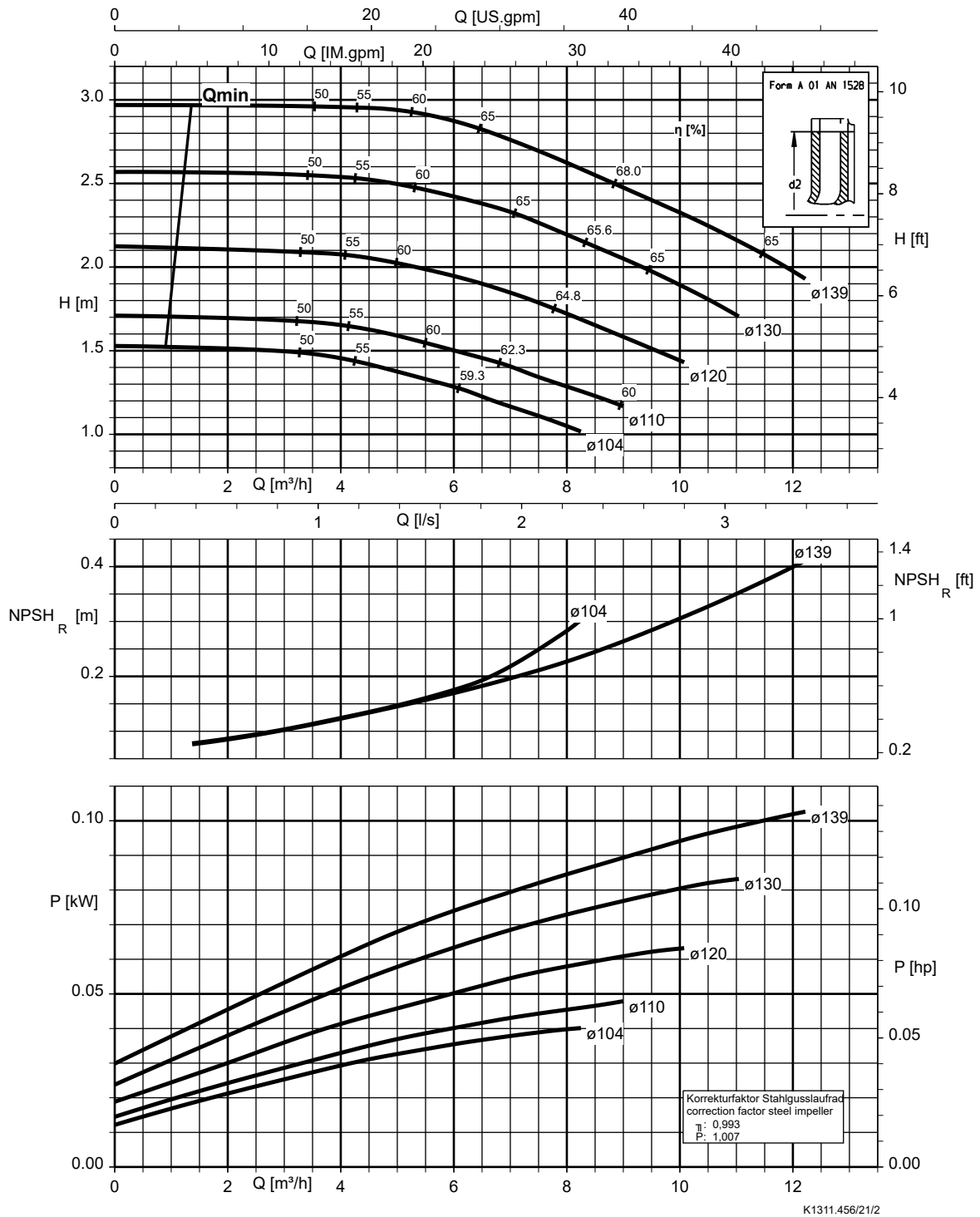

Vlet 050-032-160, n = 960 rpm

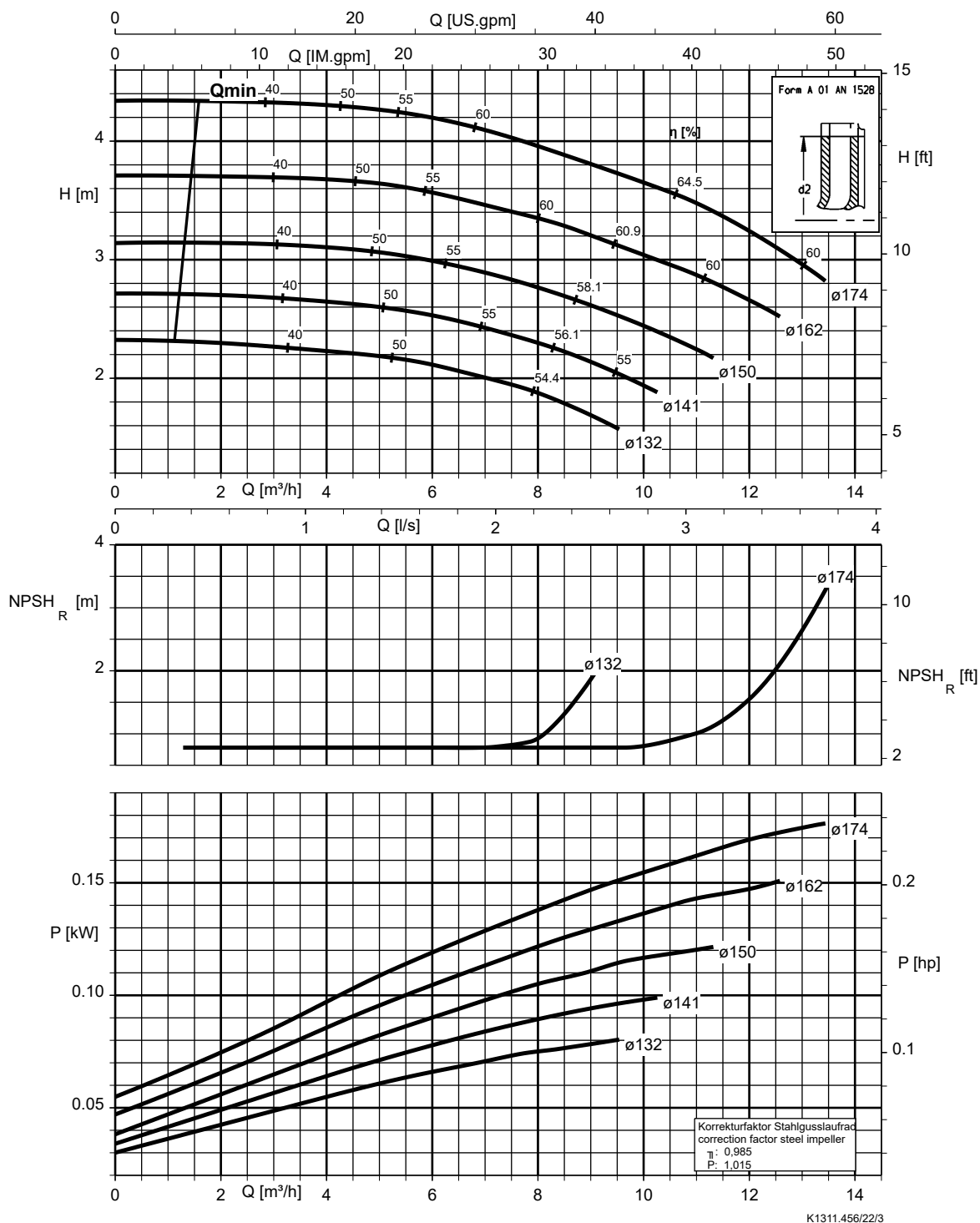

Vlet 050-032-200, n = 960 rpm

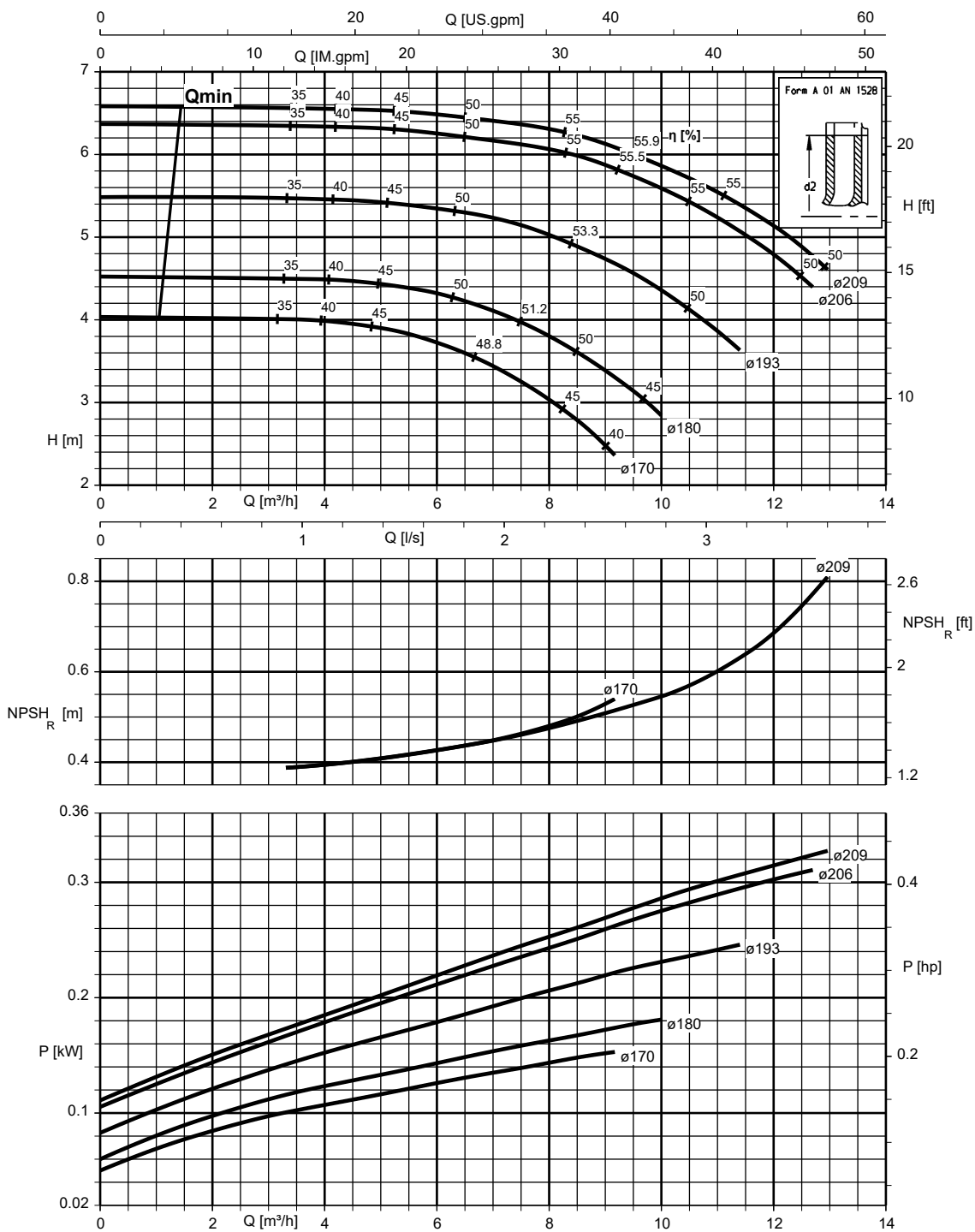

Vlet 050-032-250, n = 960 rpm

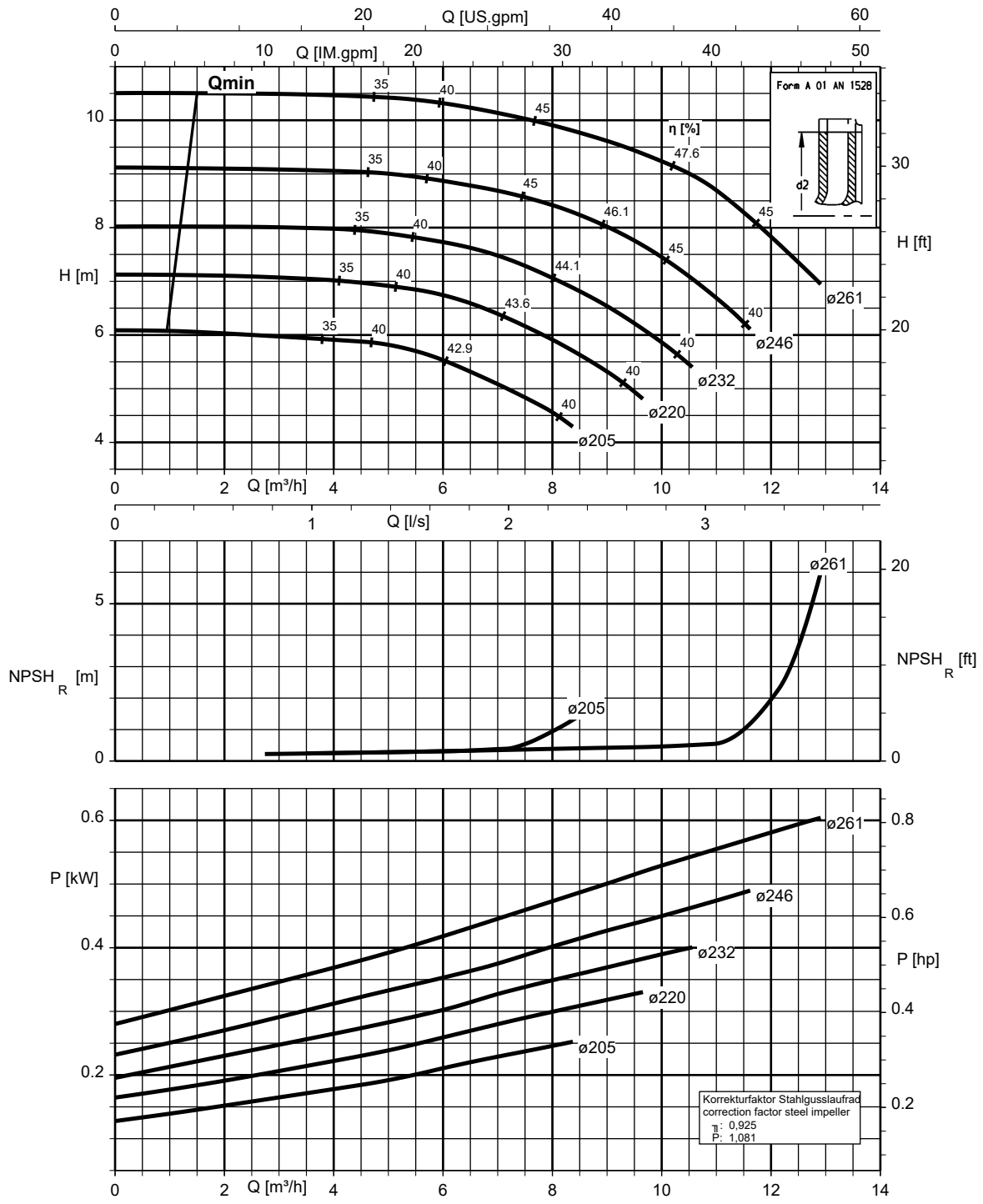

Vlet 065-040-125, n = 960 rpm

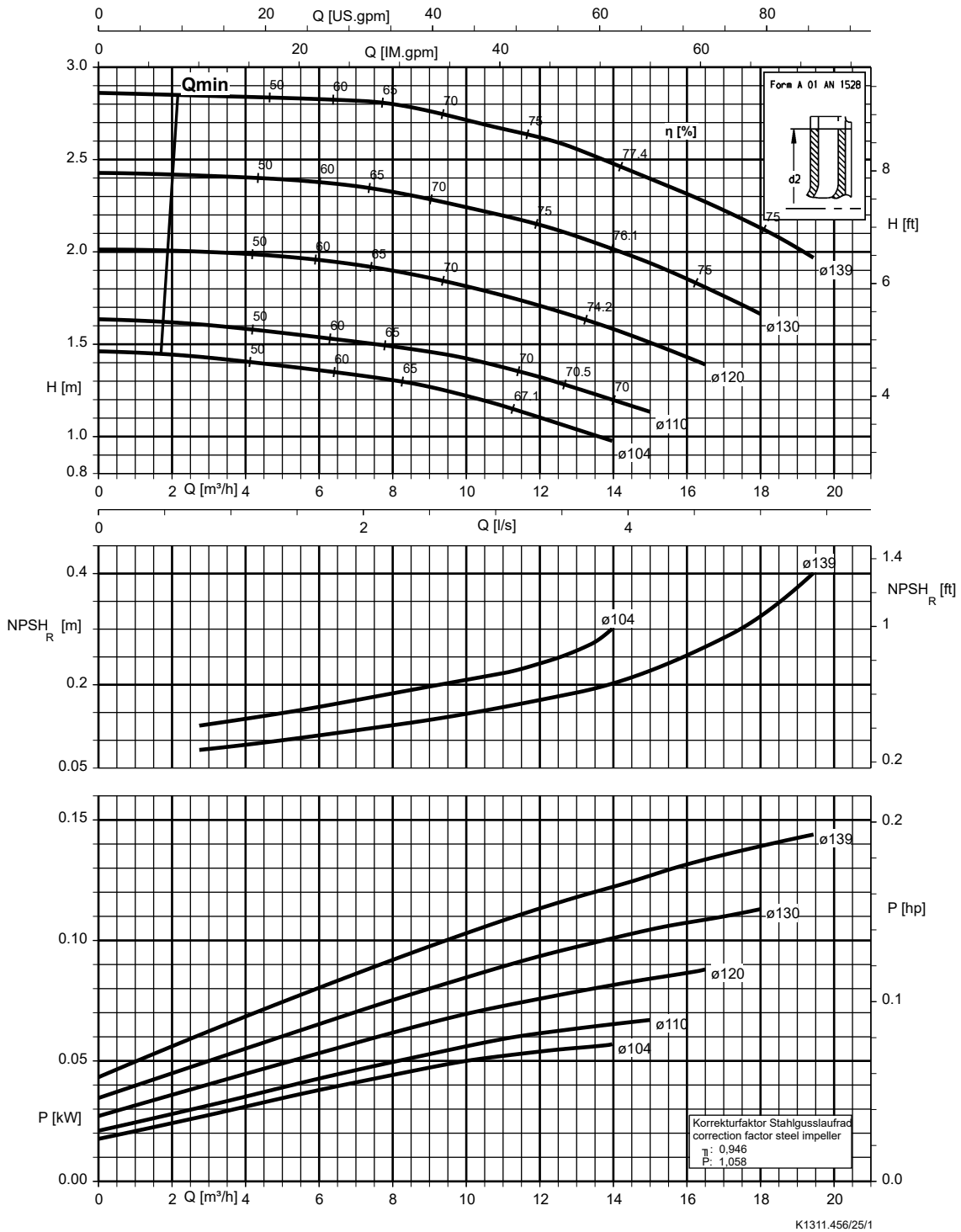

Vlet 065-040-160, n = 960 rpm

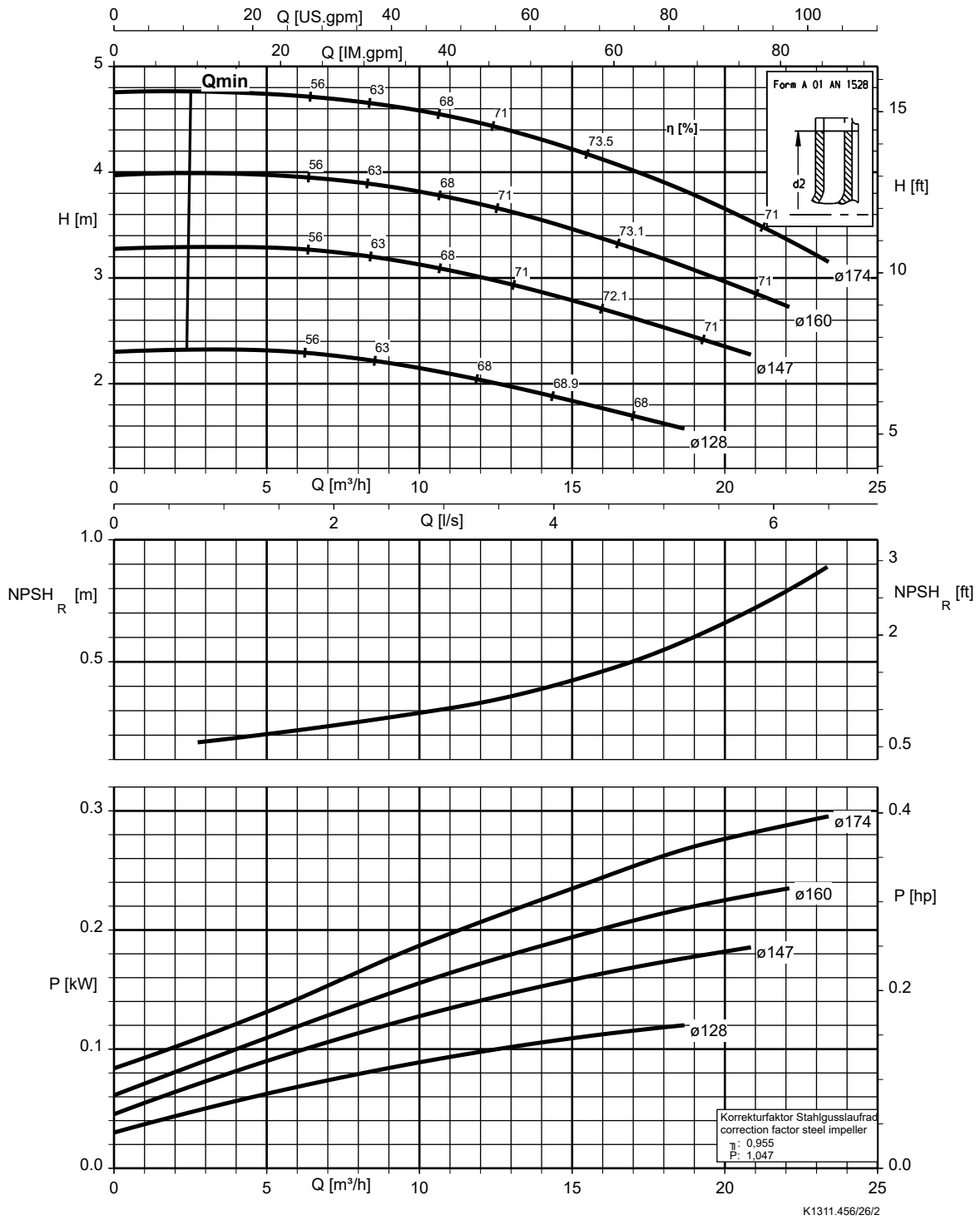

Vlet 065-040-200, n = 960 rpm

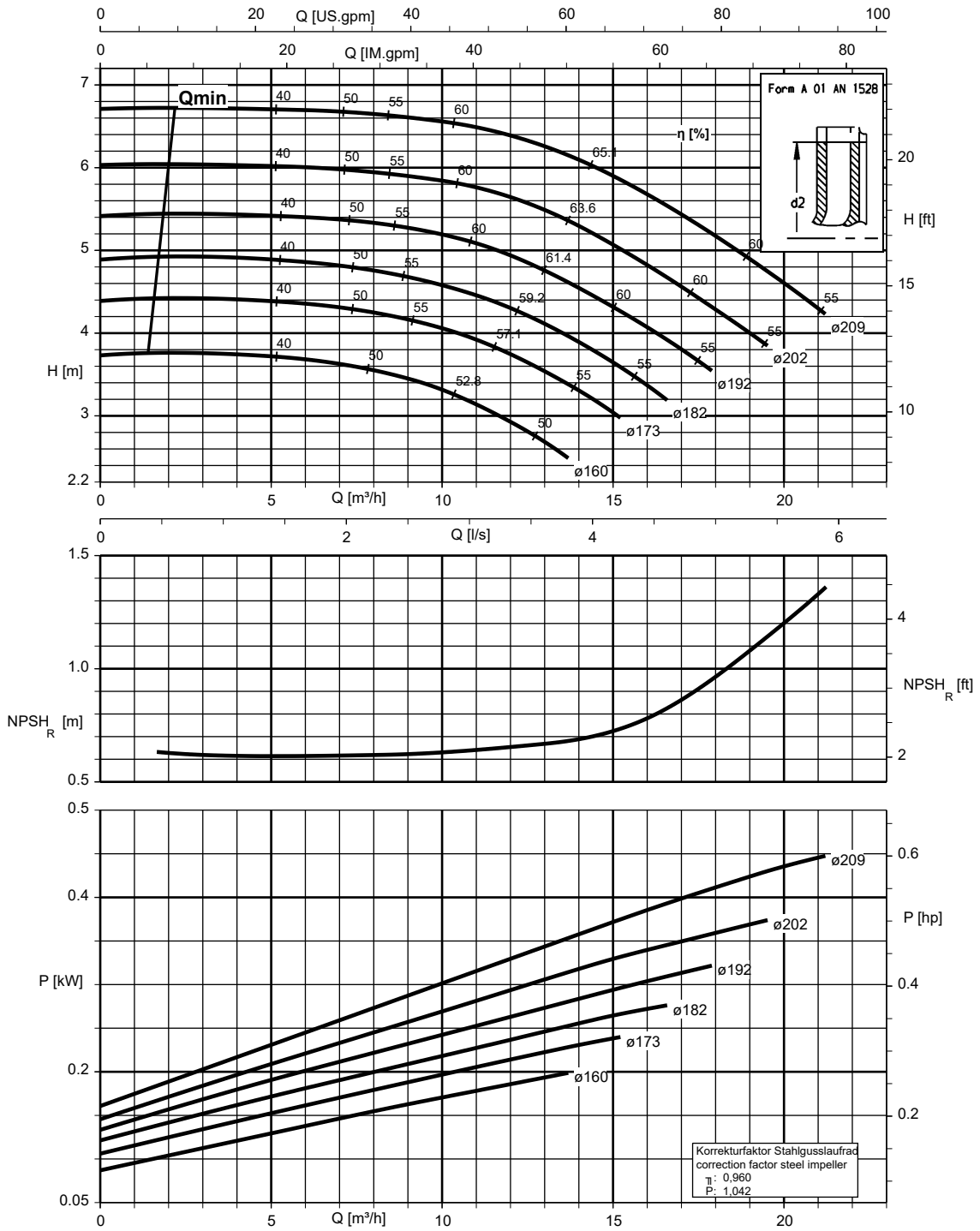

K1311.456/27/1

Vlet 065-040-250, n = 960 rpm

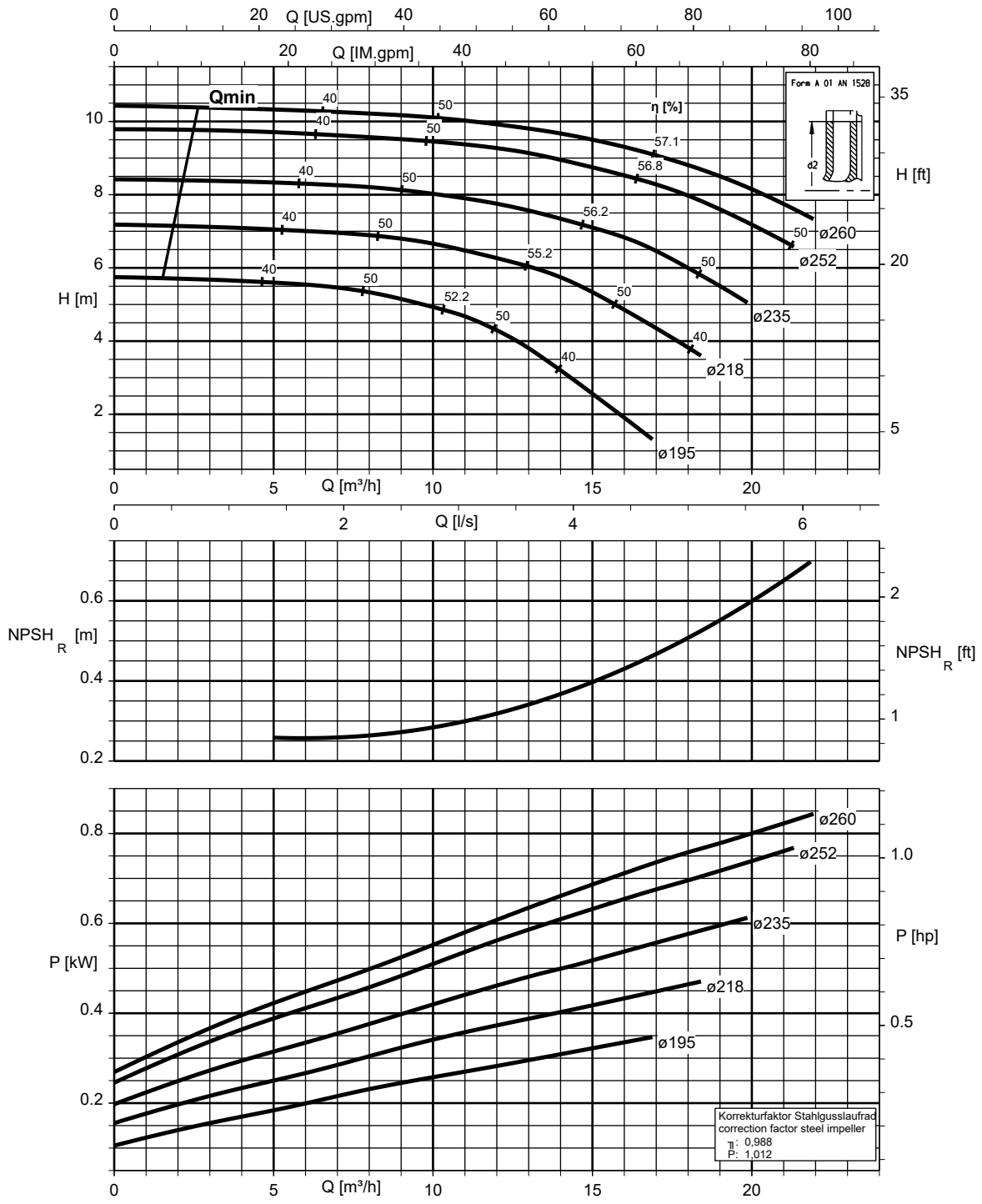

K1311.456/28/2

Vlet 065-040-315, n = 960 rpm

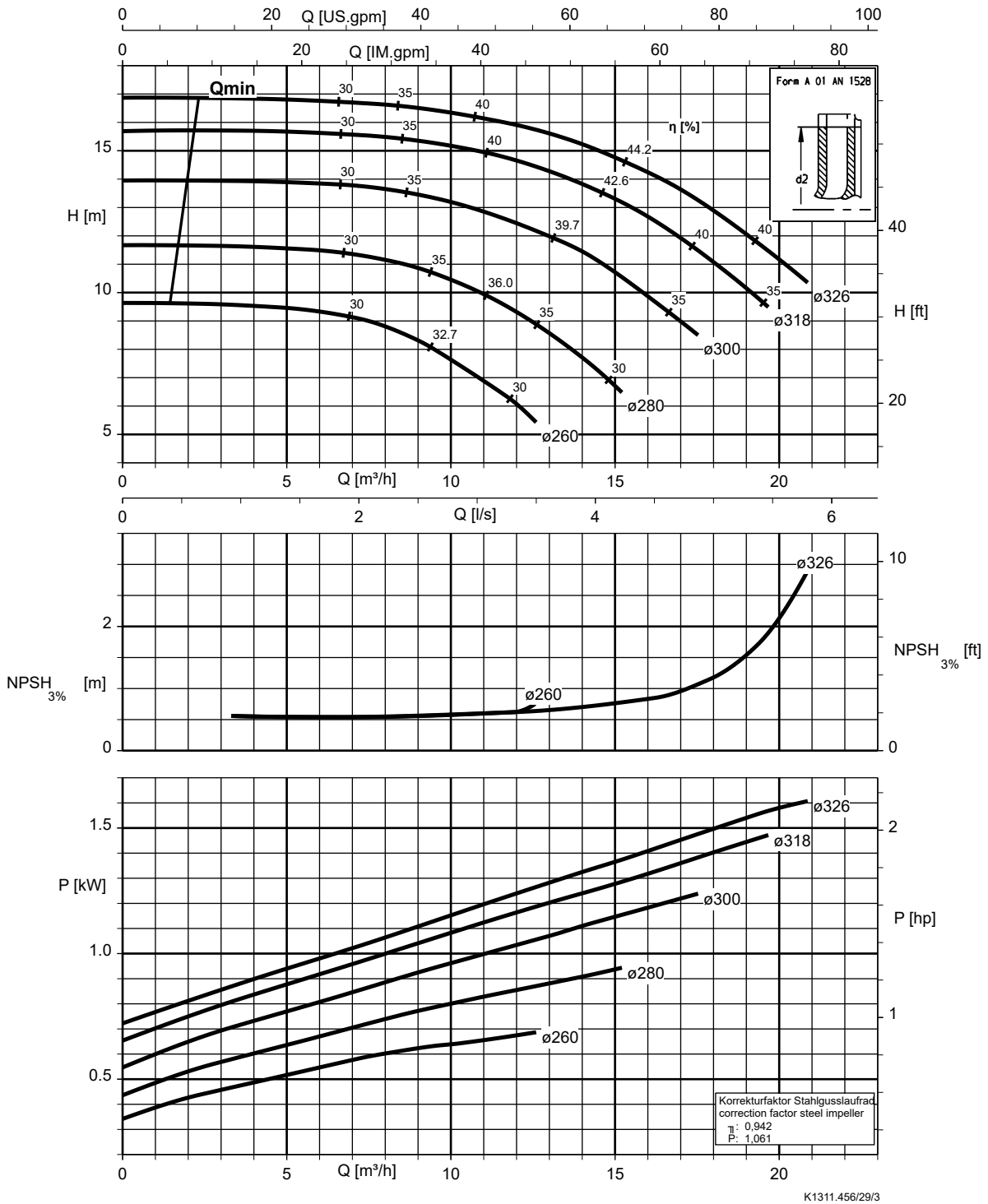

Vlet 065-050-125, n = 960 rpm

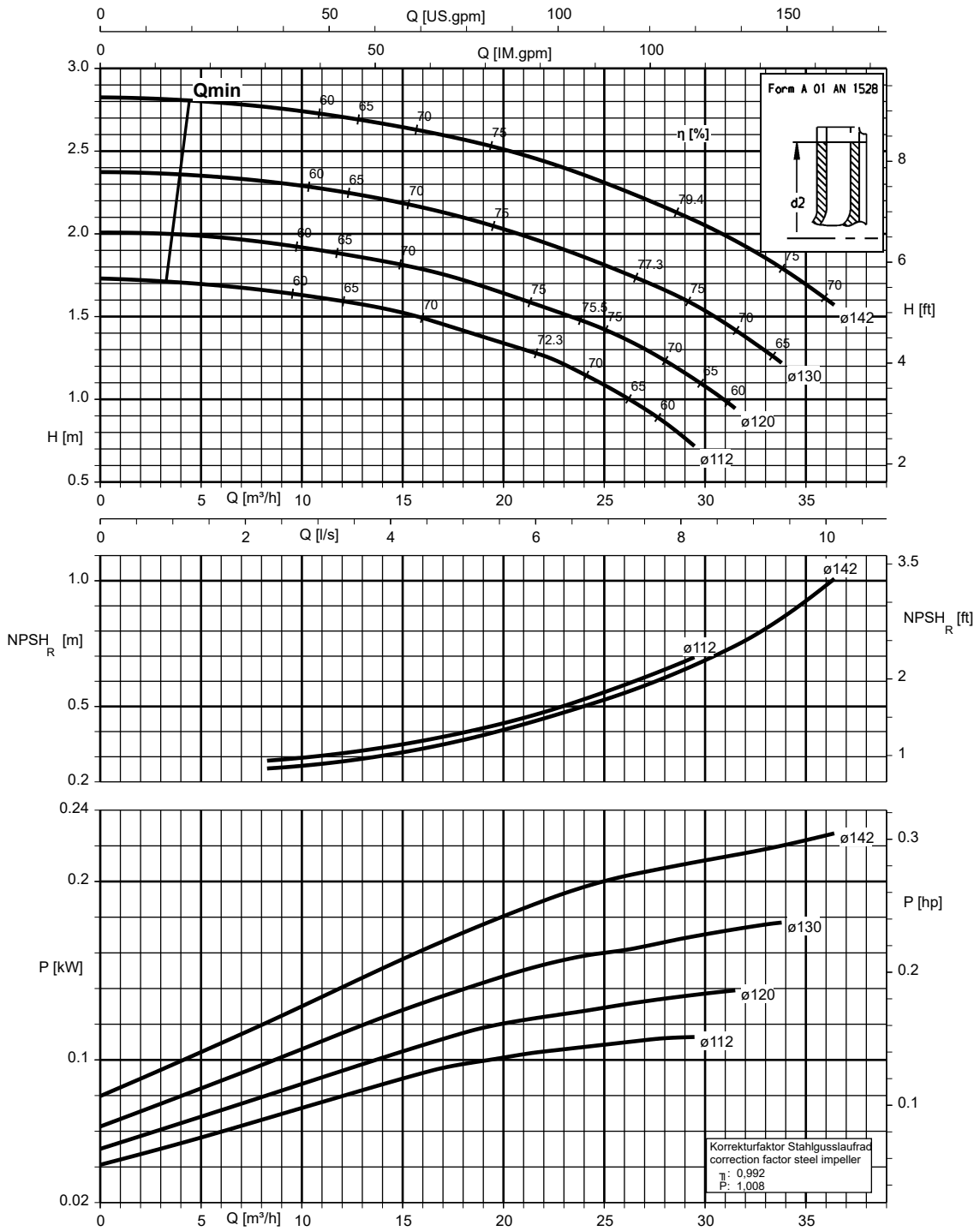

K1311.456/30/1

Vlet 065-050-160, n = 960 rpm

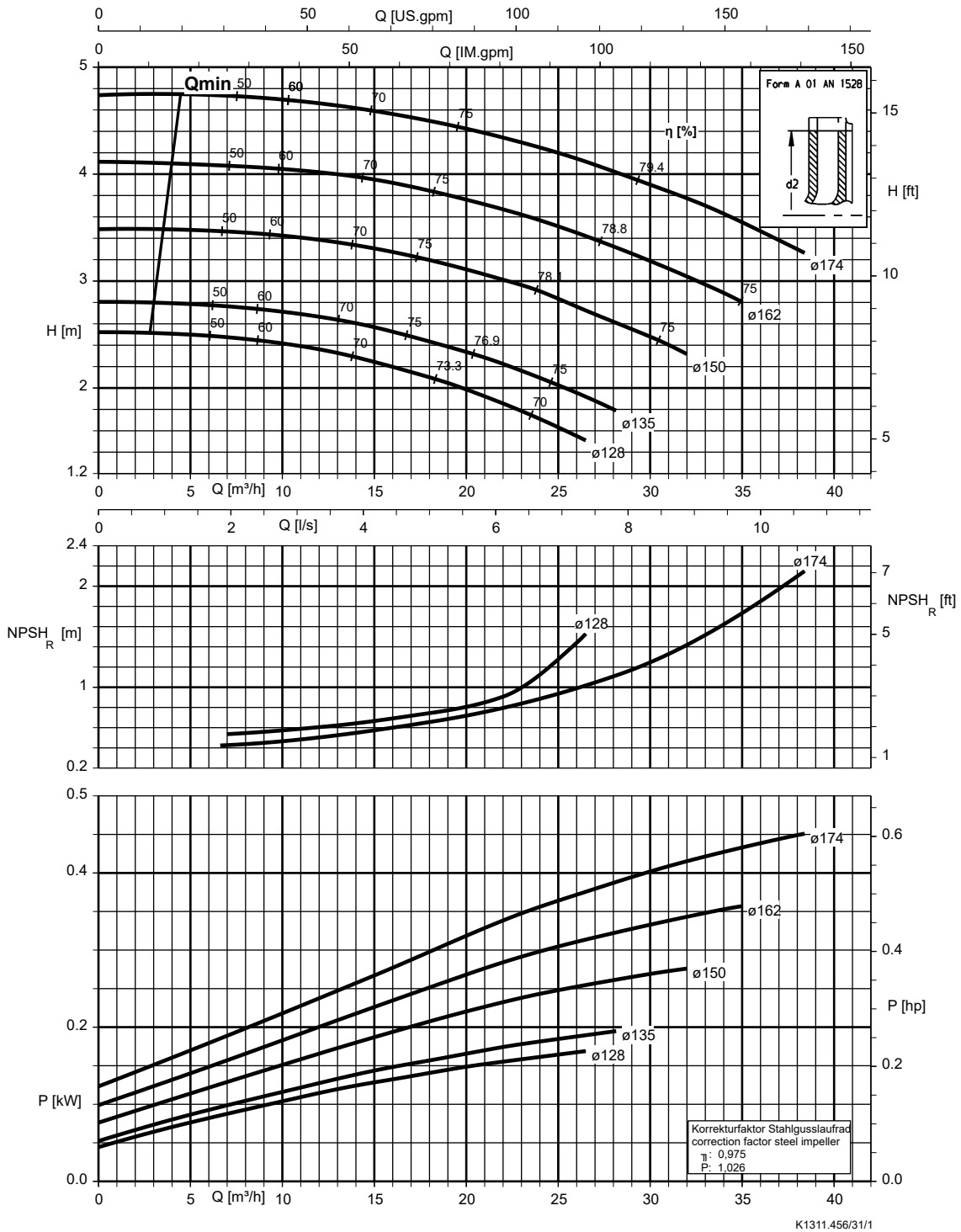

Vlet 065-050-200, n = 960 rpm

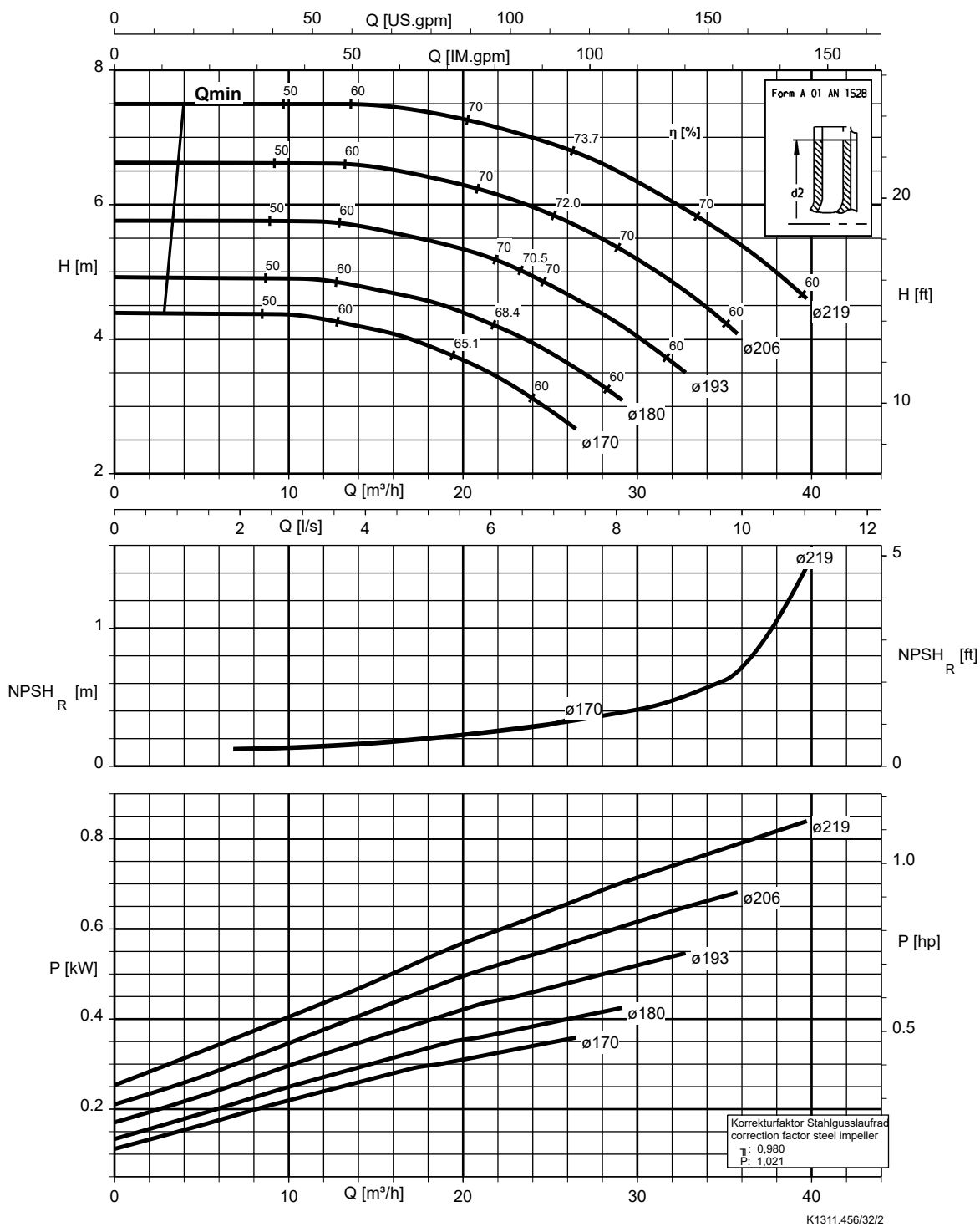

Vlet 065-050-250, n = 960 rpm

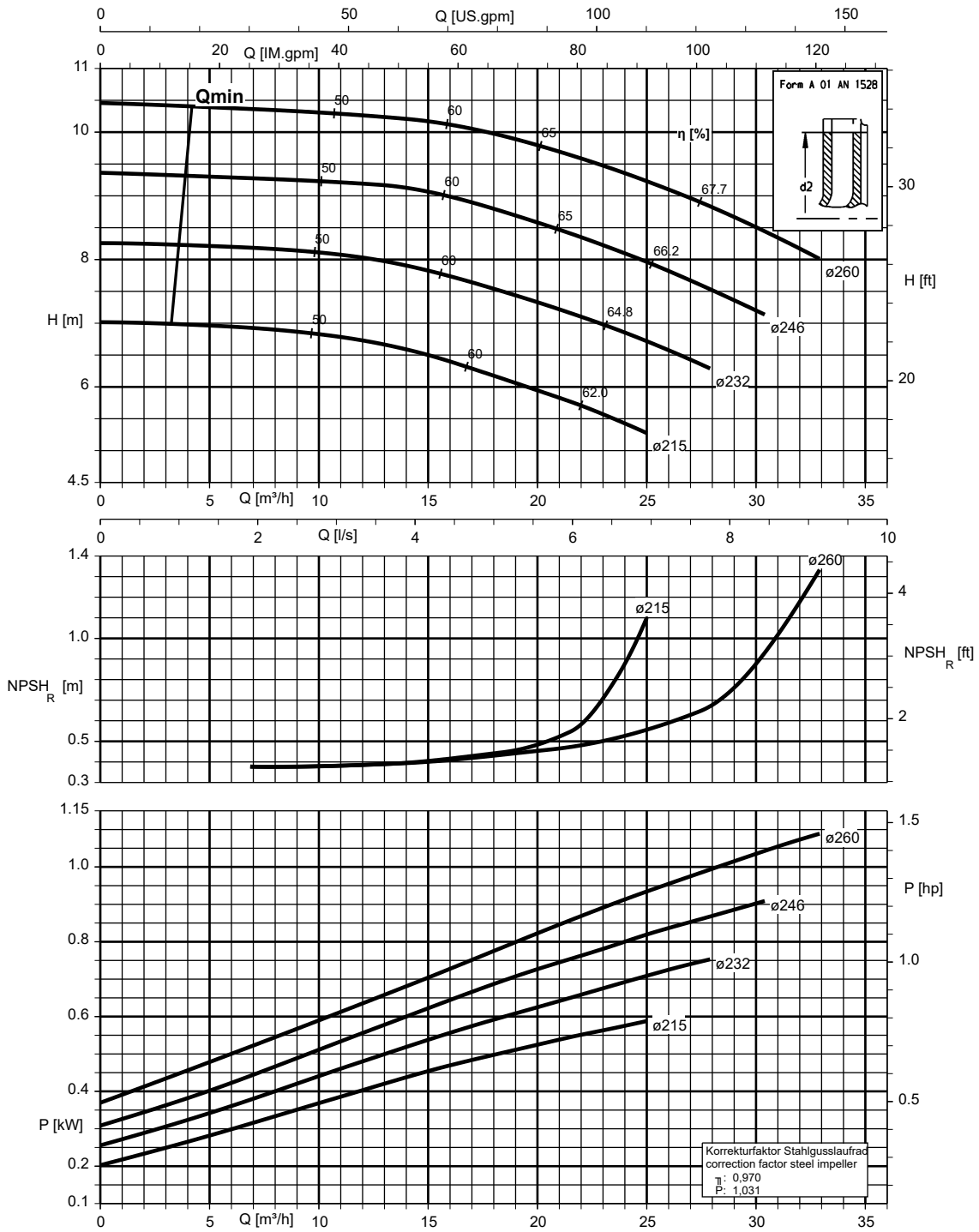

K1311.456/33/1

Vlet 065-050-315, n = 960 rpm

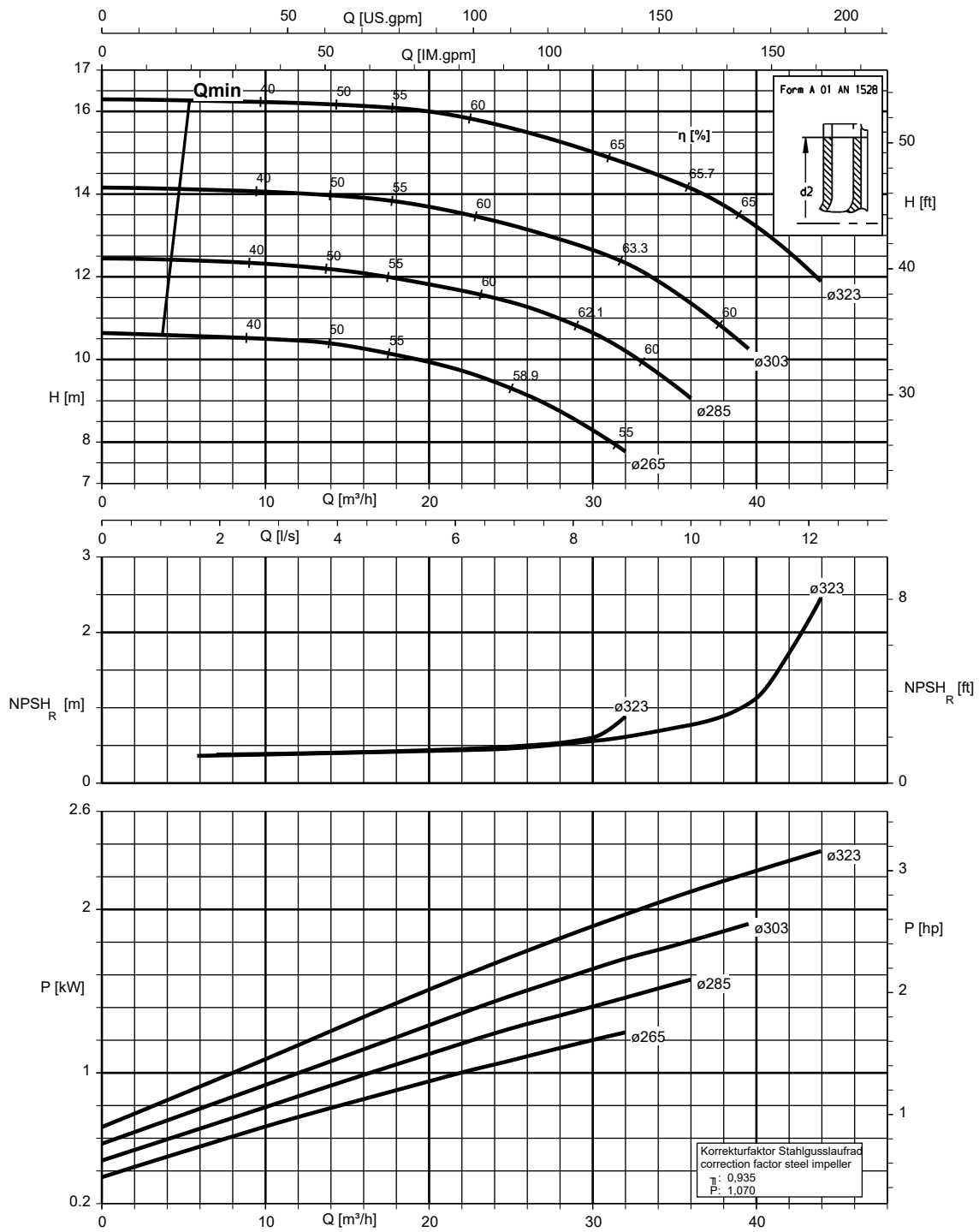

K1311.456/34/2

Vlet 080-065-125, n = 960 rpm

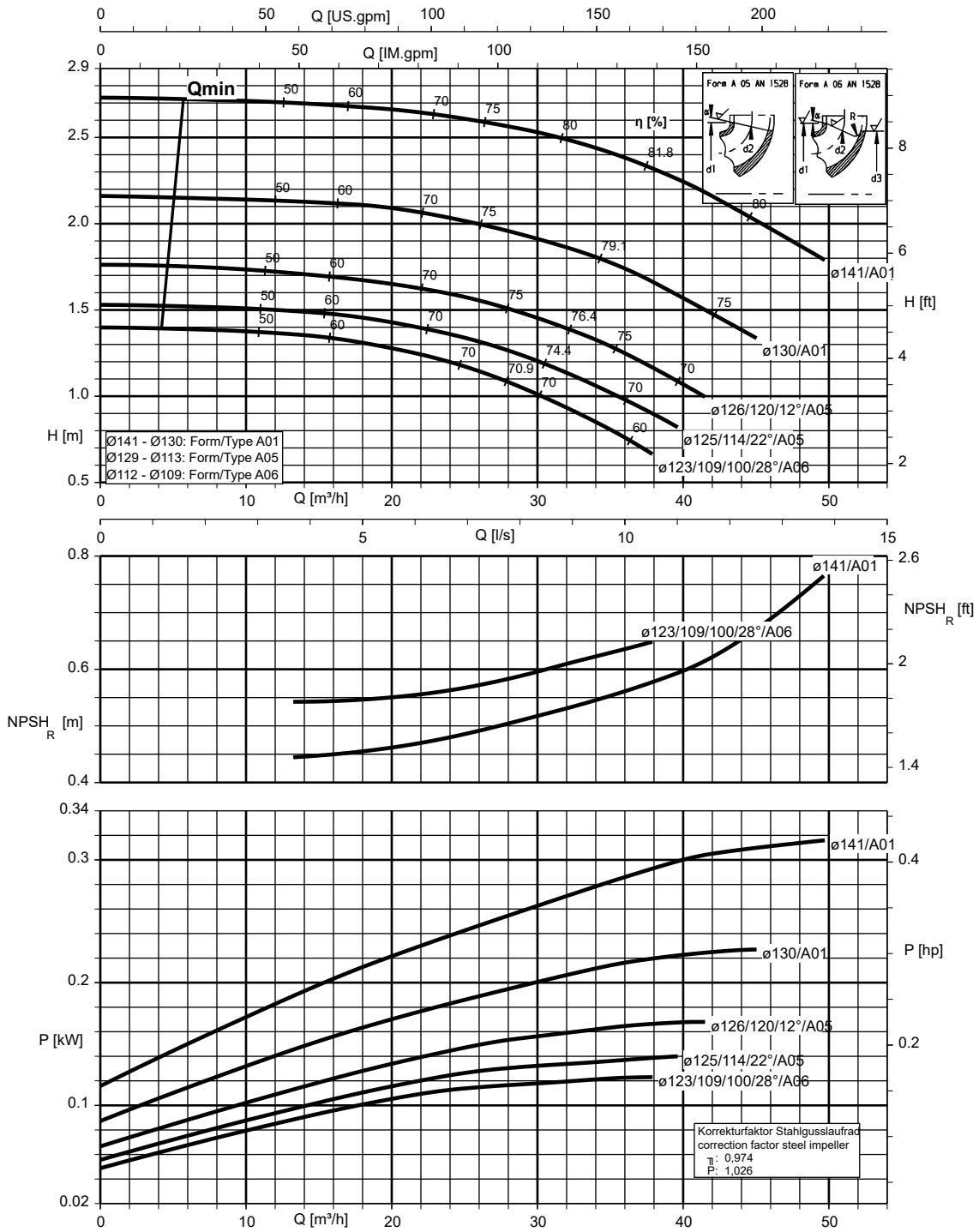

K1311.456/35/2

Vlet 080-065-160, n = 960 rpm

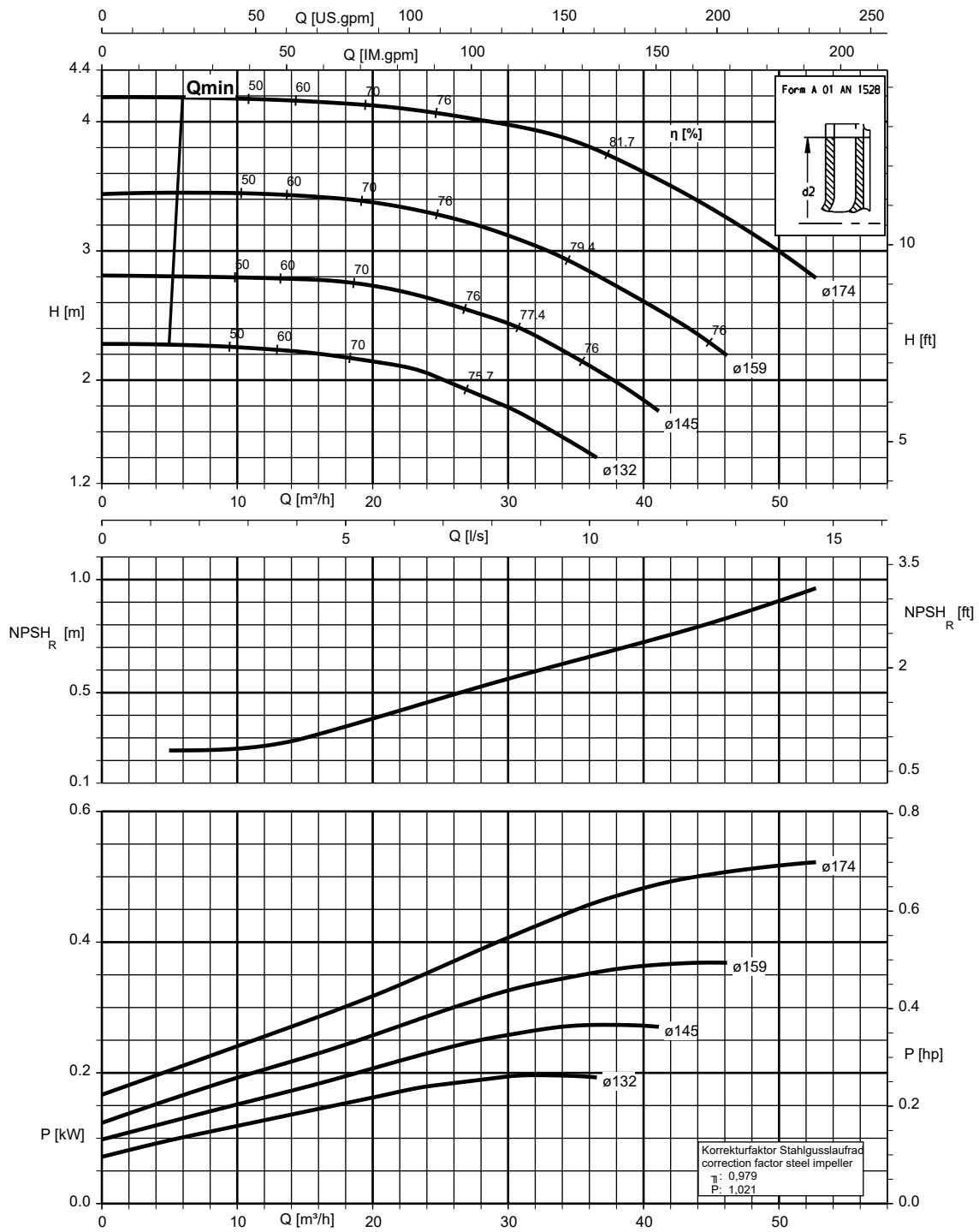

K1311.456/36/2

Vlet 080-065-200, n = 960 rpm

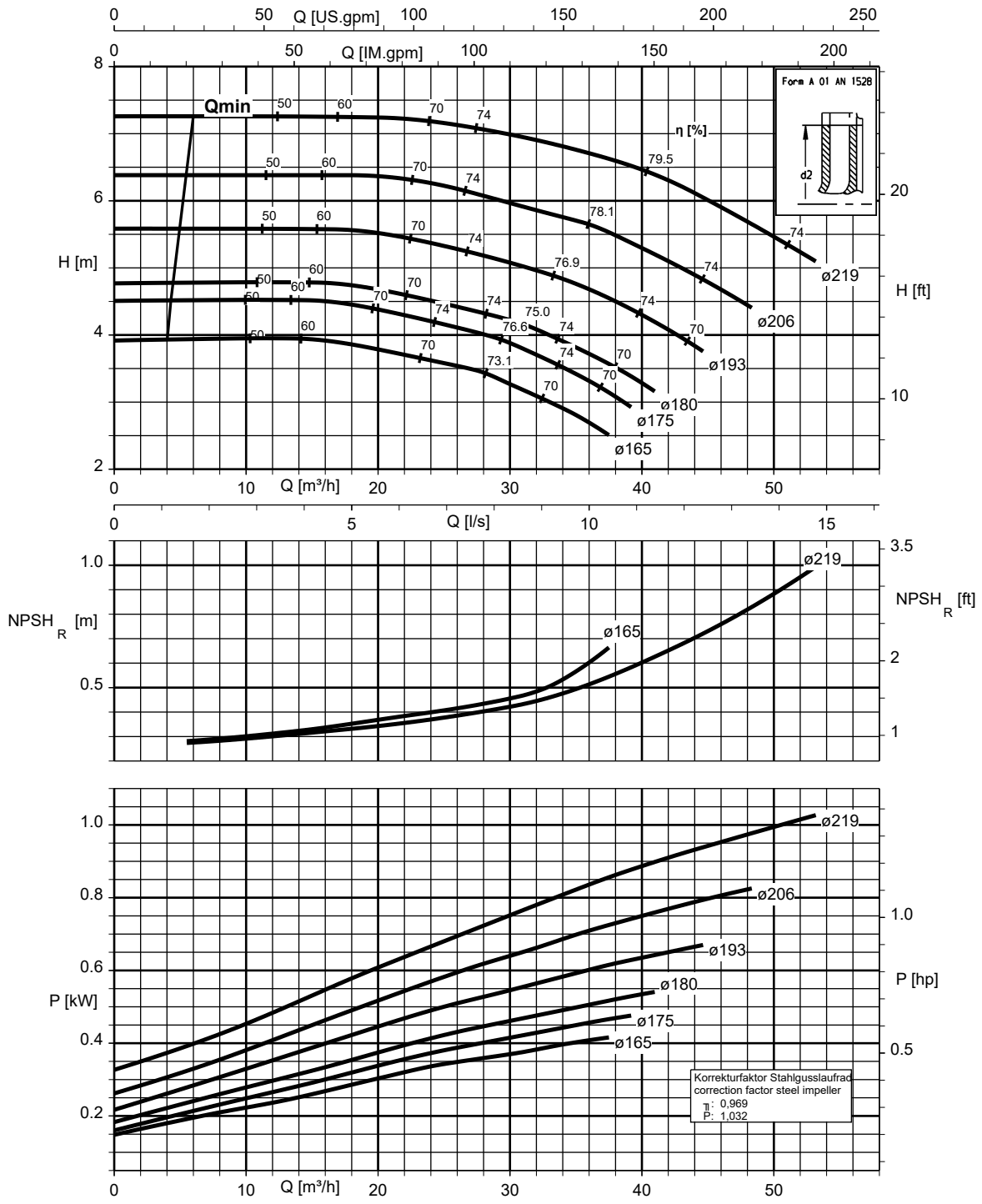

K1311.456/37/2

Vlet 080-065-250, n = 960 rpm

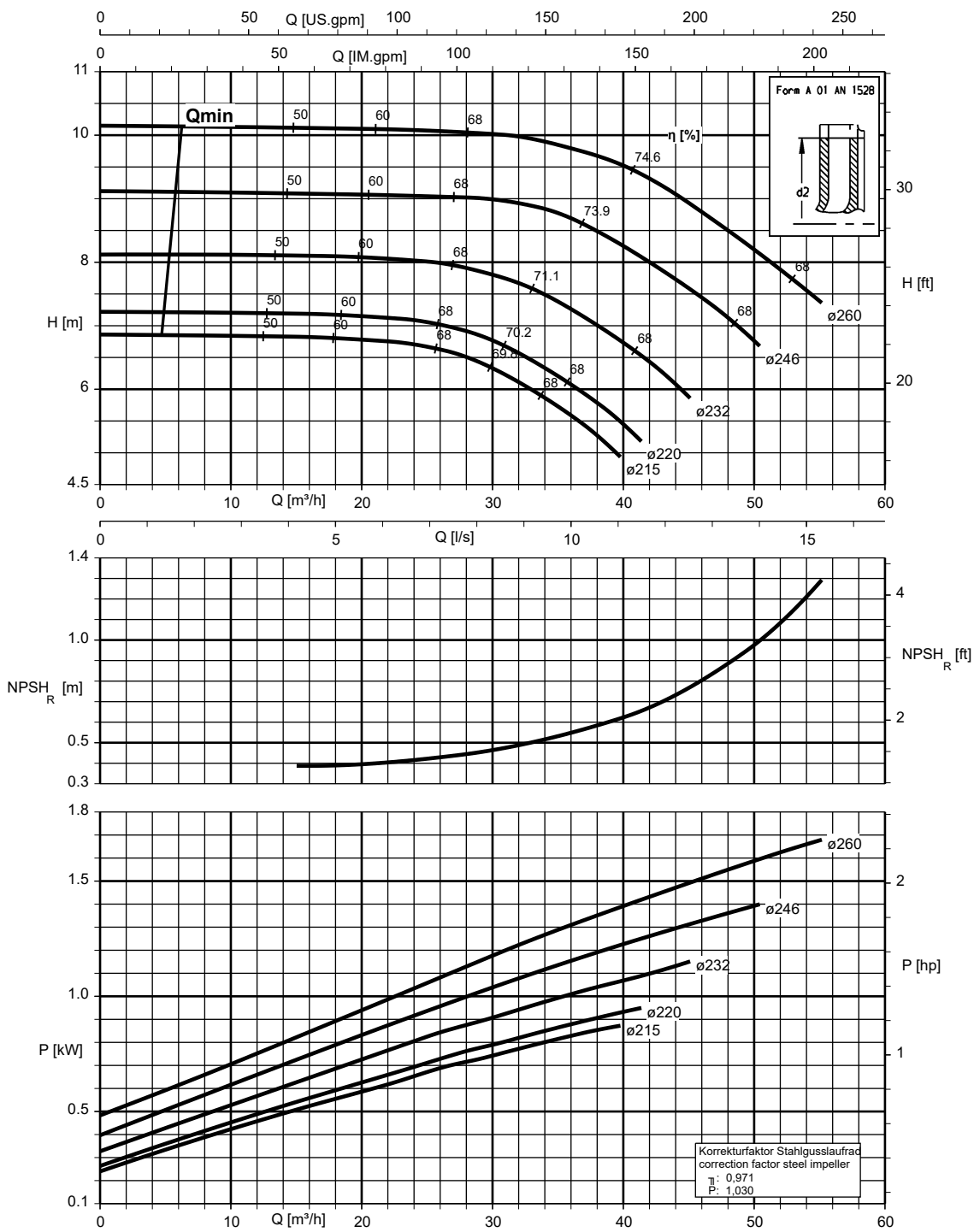

K1311.456/38/2

Vlet 080-065-315, n = 960 rpm

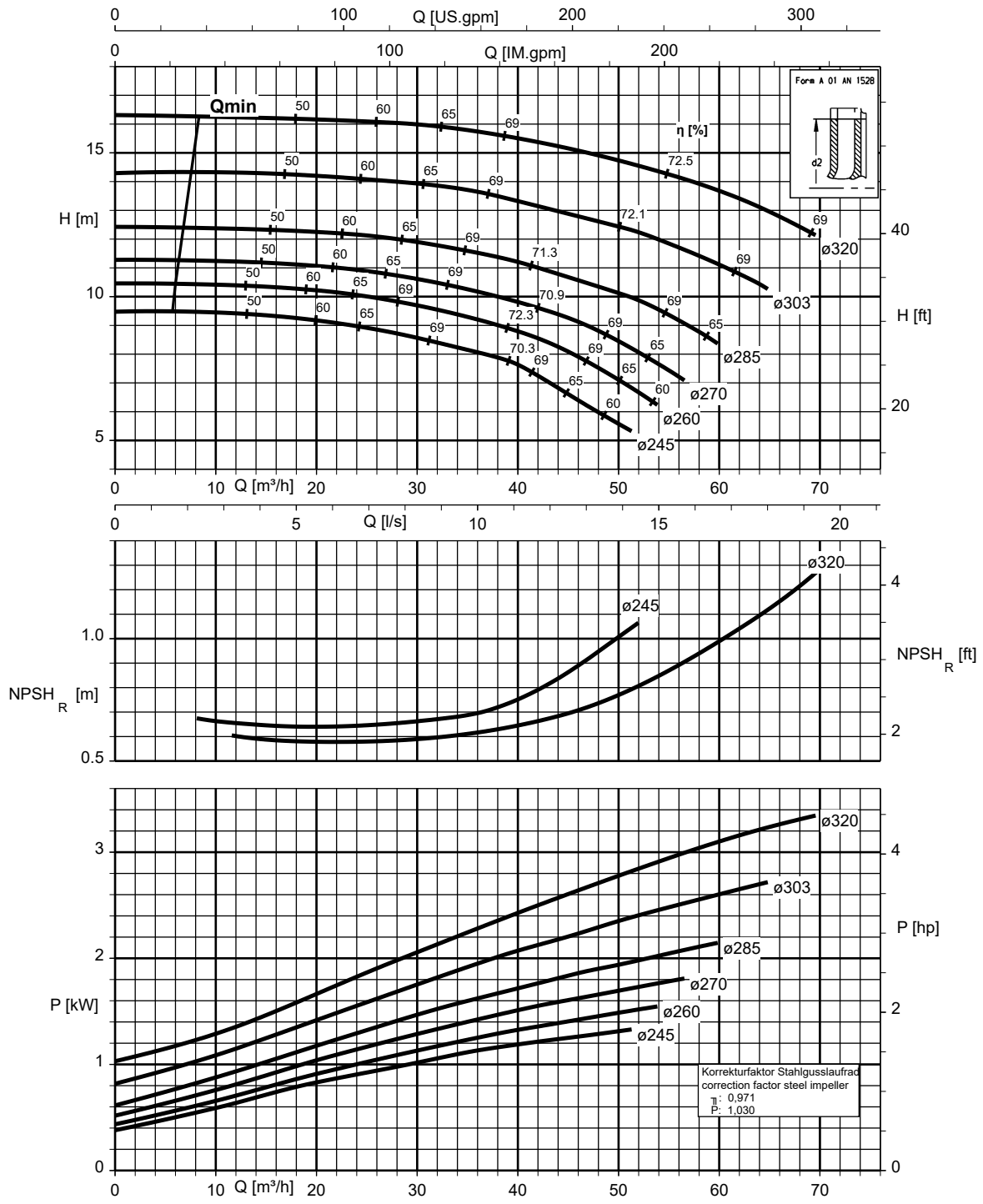

K1311.456/39/2

Vlet 100-080-160, n = 960 rpm

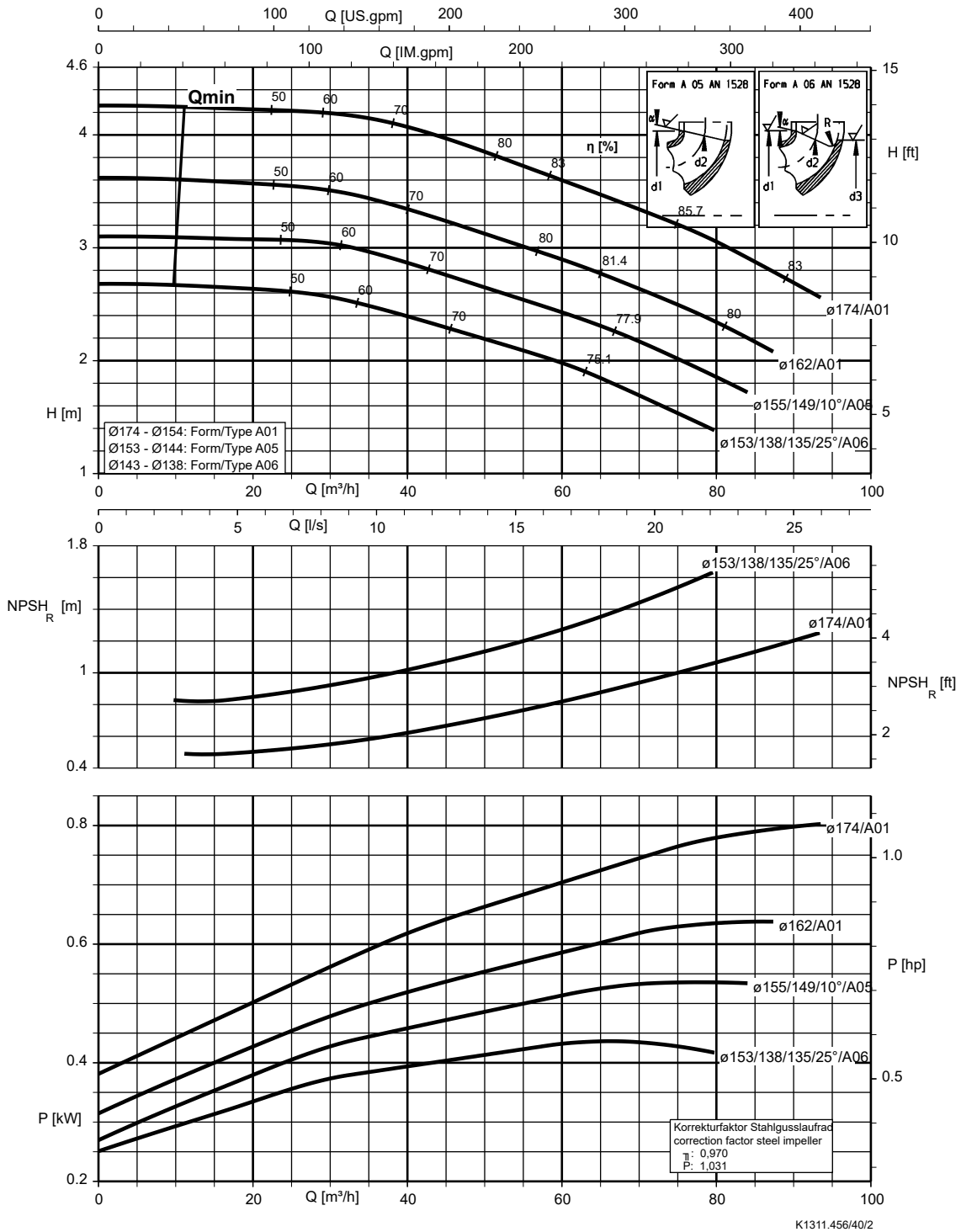

Vlet 100-080-200, n = 960 rpm

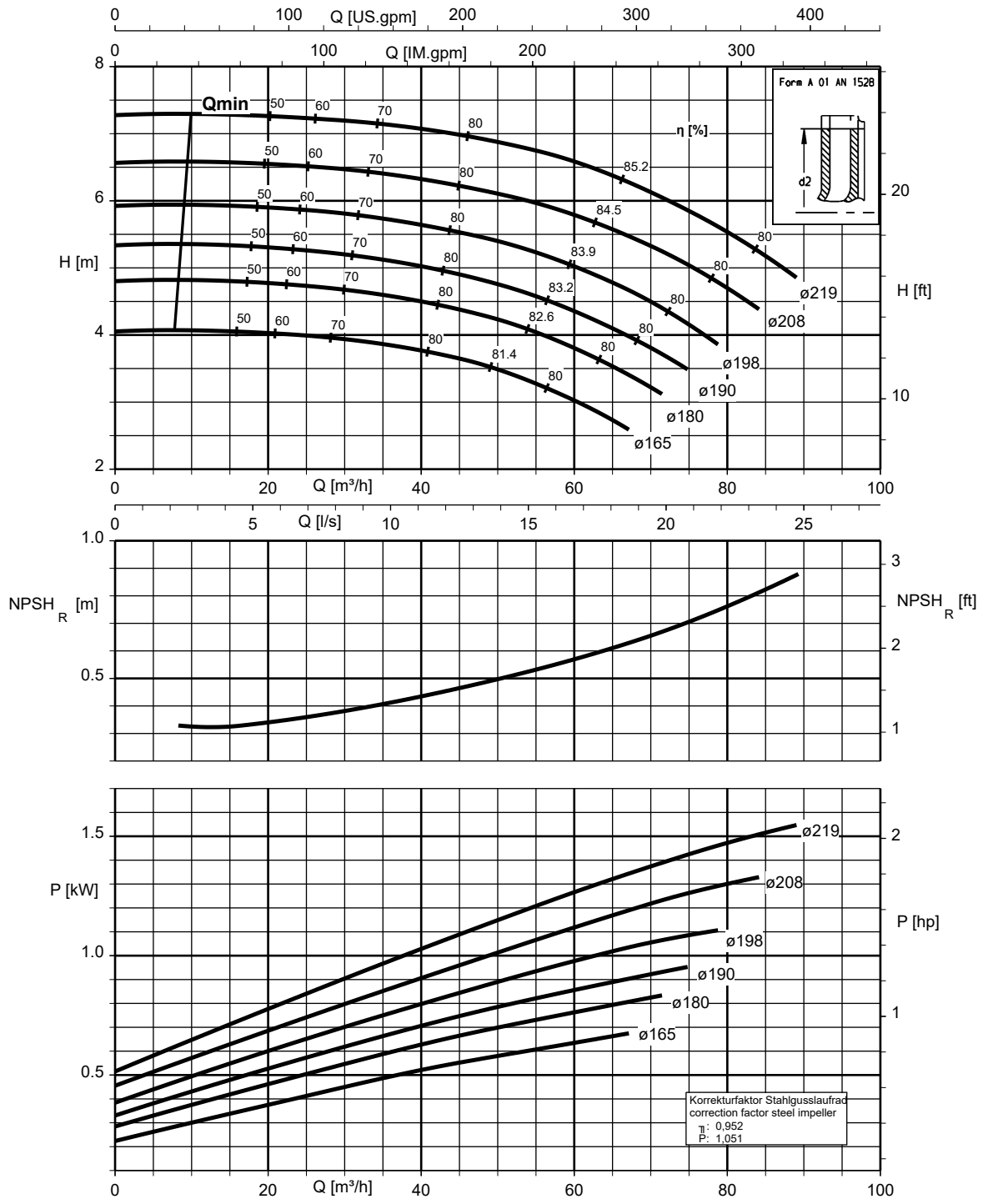

Vlet 100-080-250, n = 960 rpm

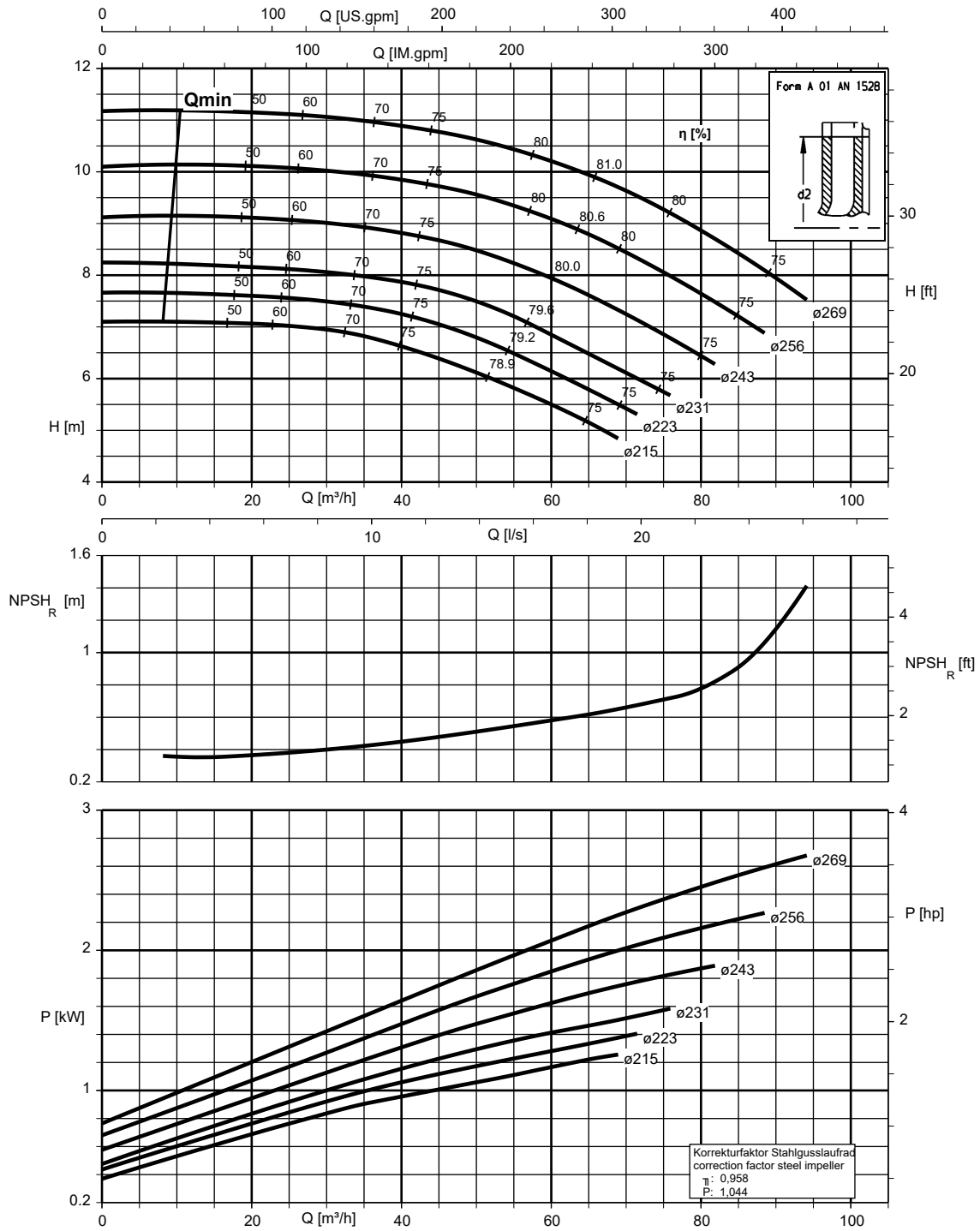

K1311.456/42/2

Vlet 100-080-315, n = 960 rpm

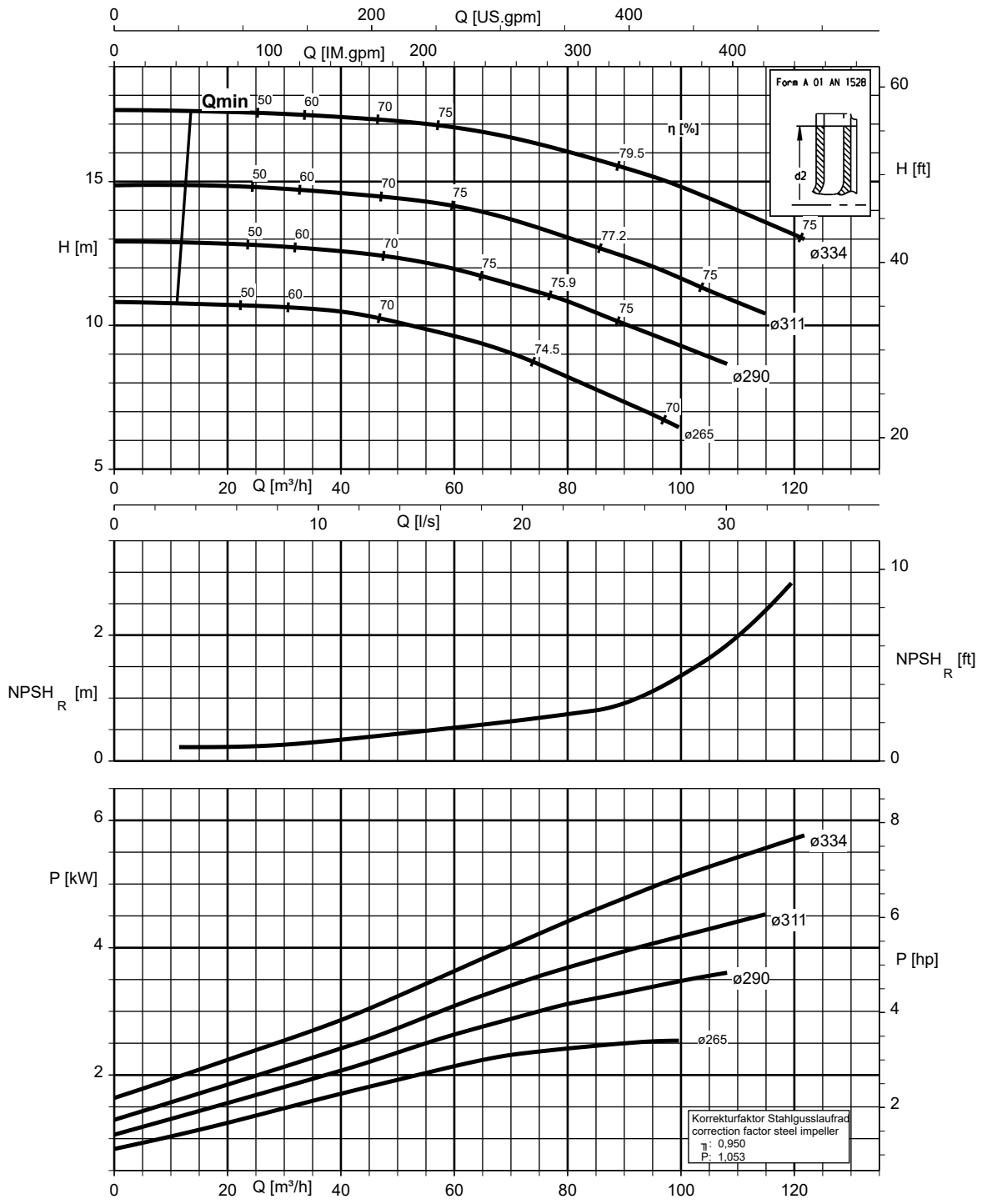

Vlet 100-080-400, n = 960 rpm

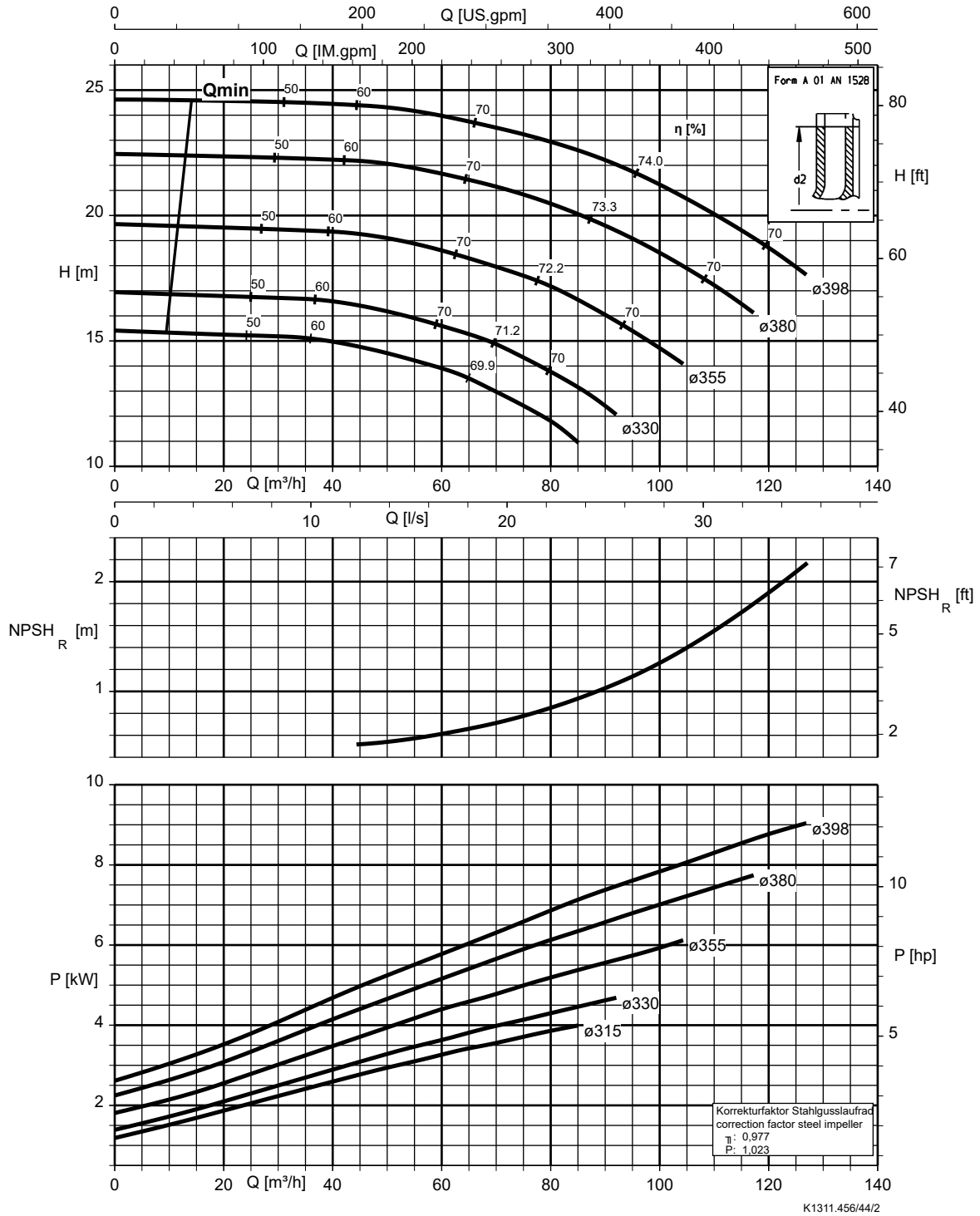

Vlet 125-100-160, n = 960 rpm

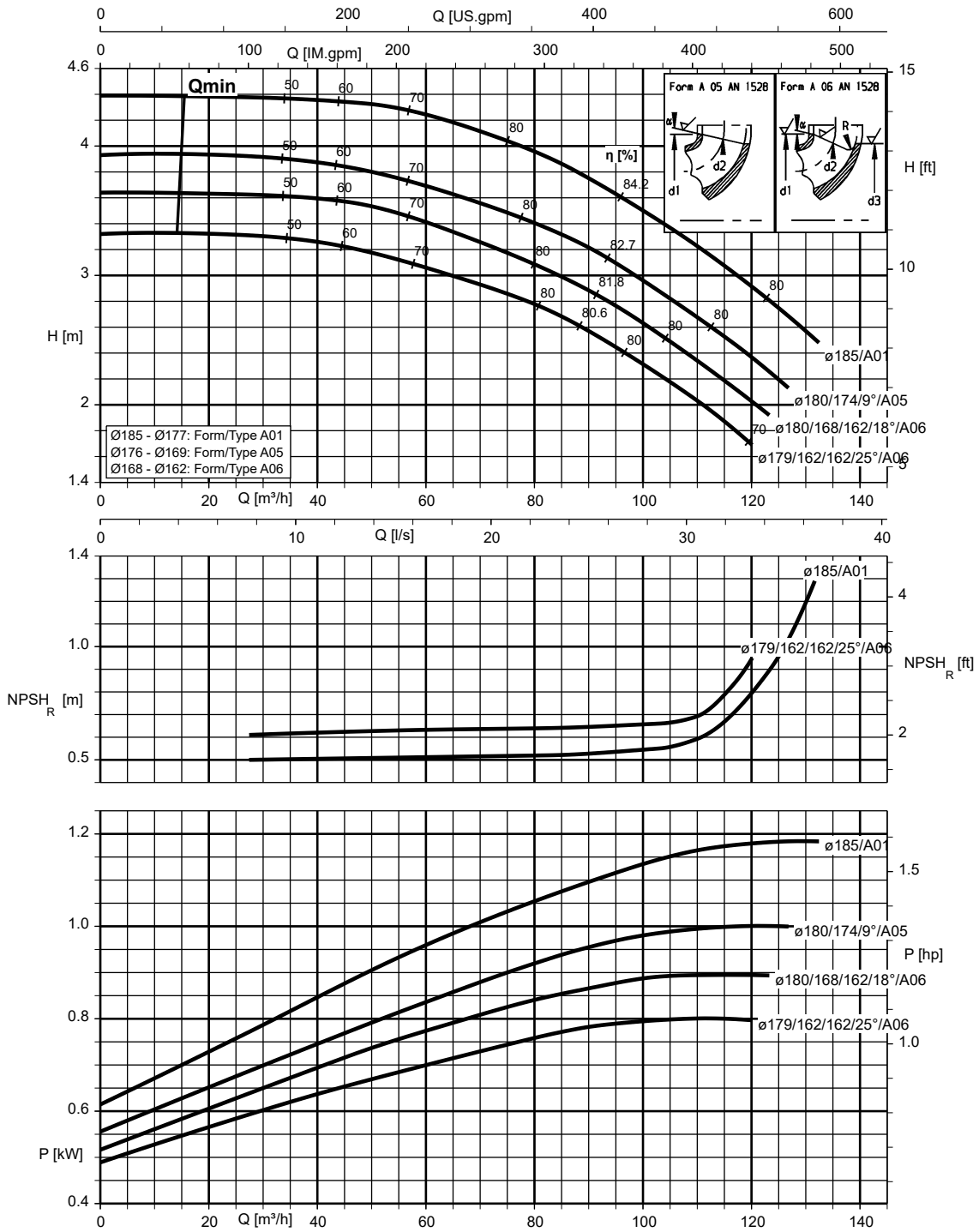

K1311.456/45/2

Vlet 125-100-200, n = 960 rpm

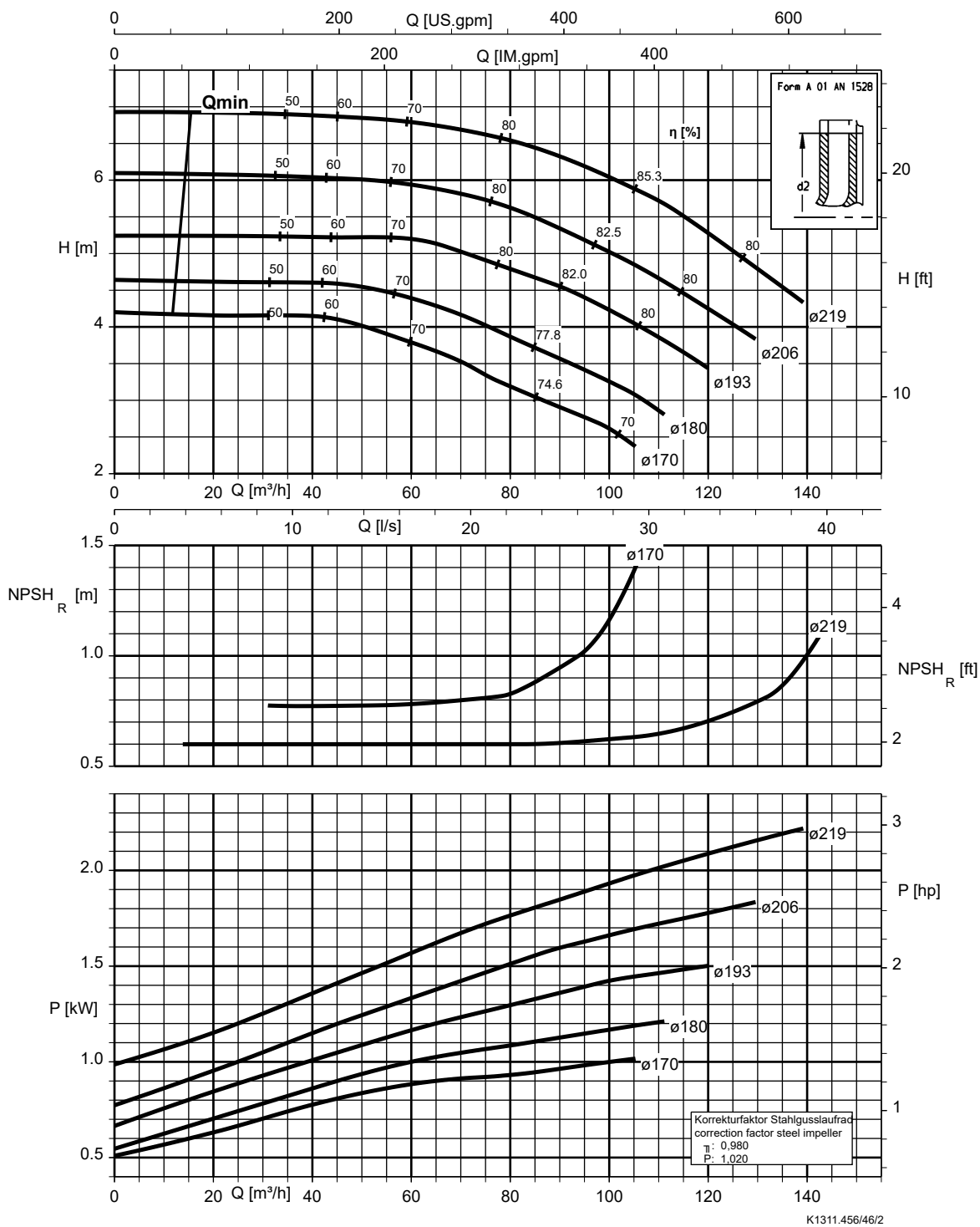

Vlet 125-100-250, n = 960 rpm

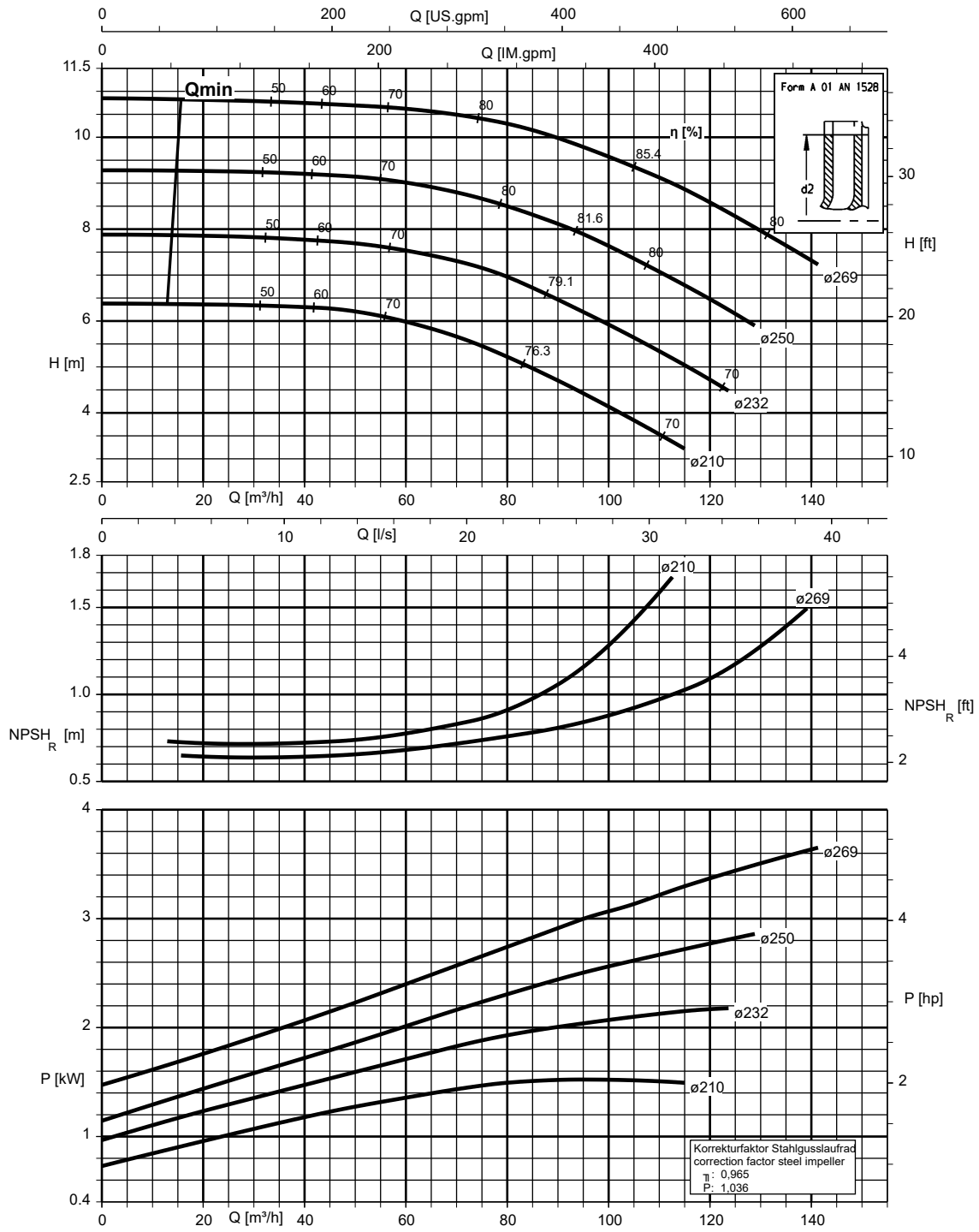

K1311.456/47/2

Vlet 125-100-315, n = 960 rpm

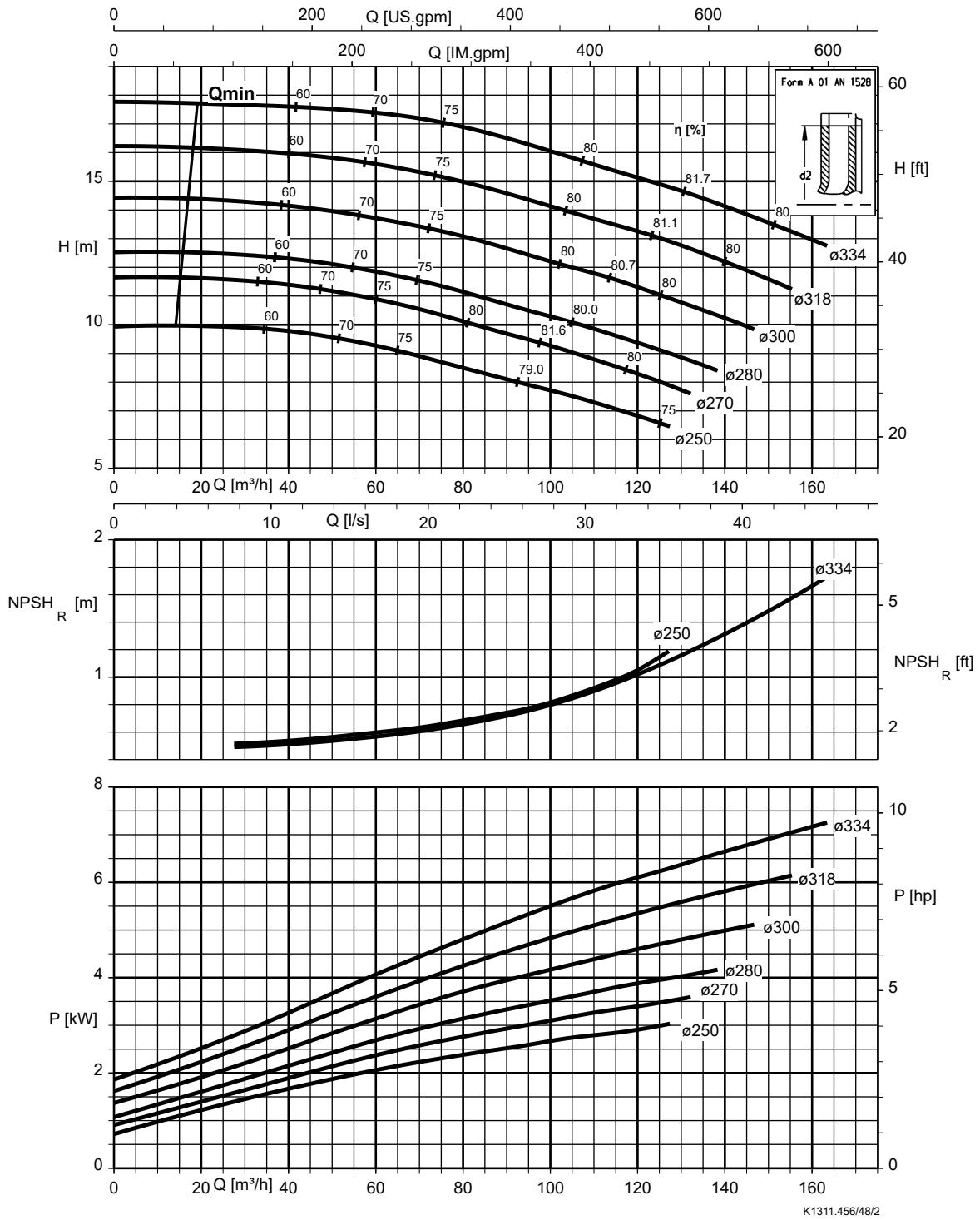

Vlet 125-100-400, n = 960 rpm

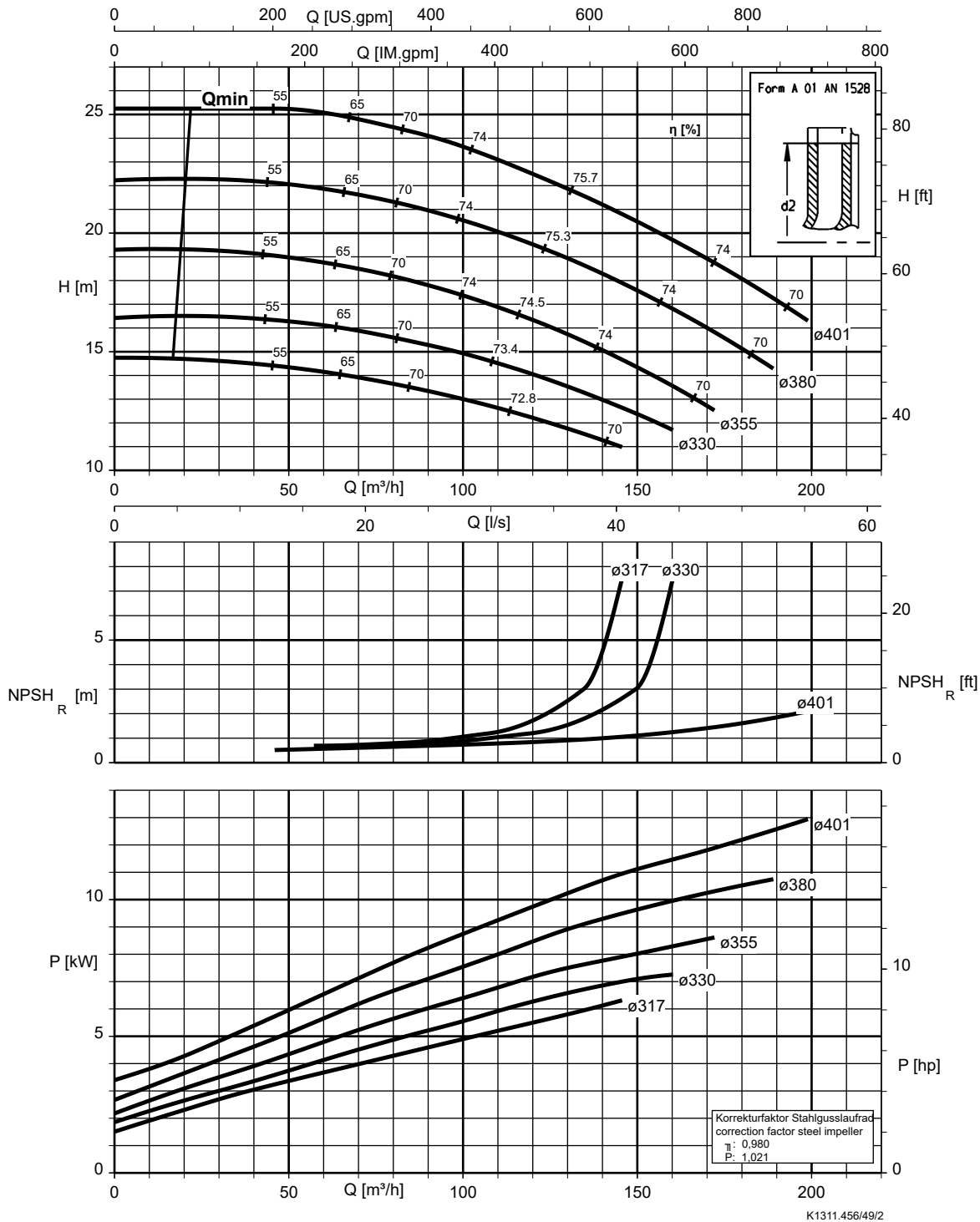

Vlet 150-125-200, n = 960 rpm

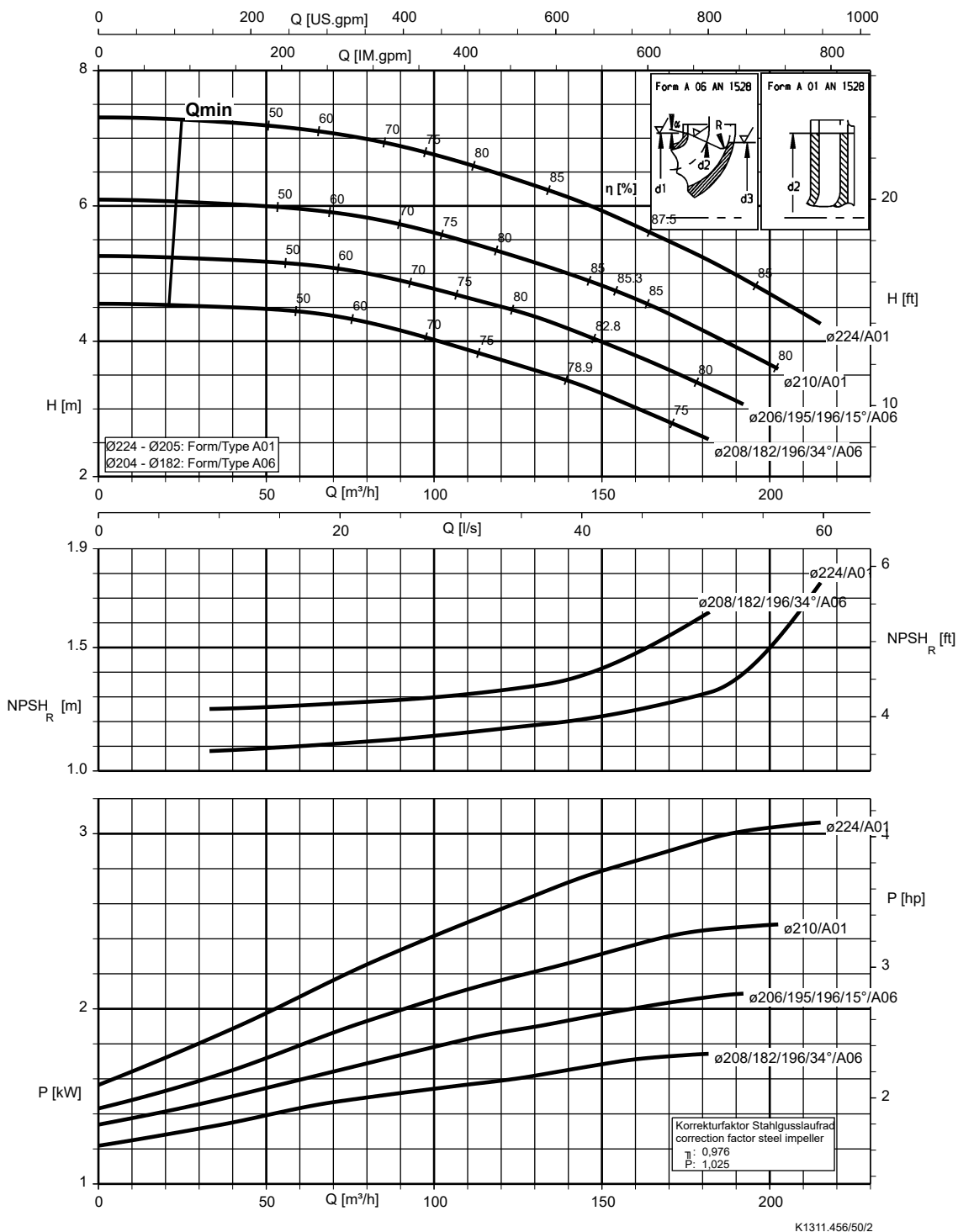

Vlet 150-125-315, n = 960 rpm

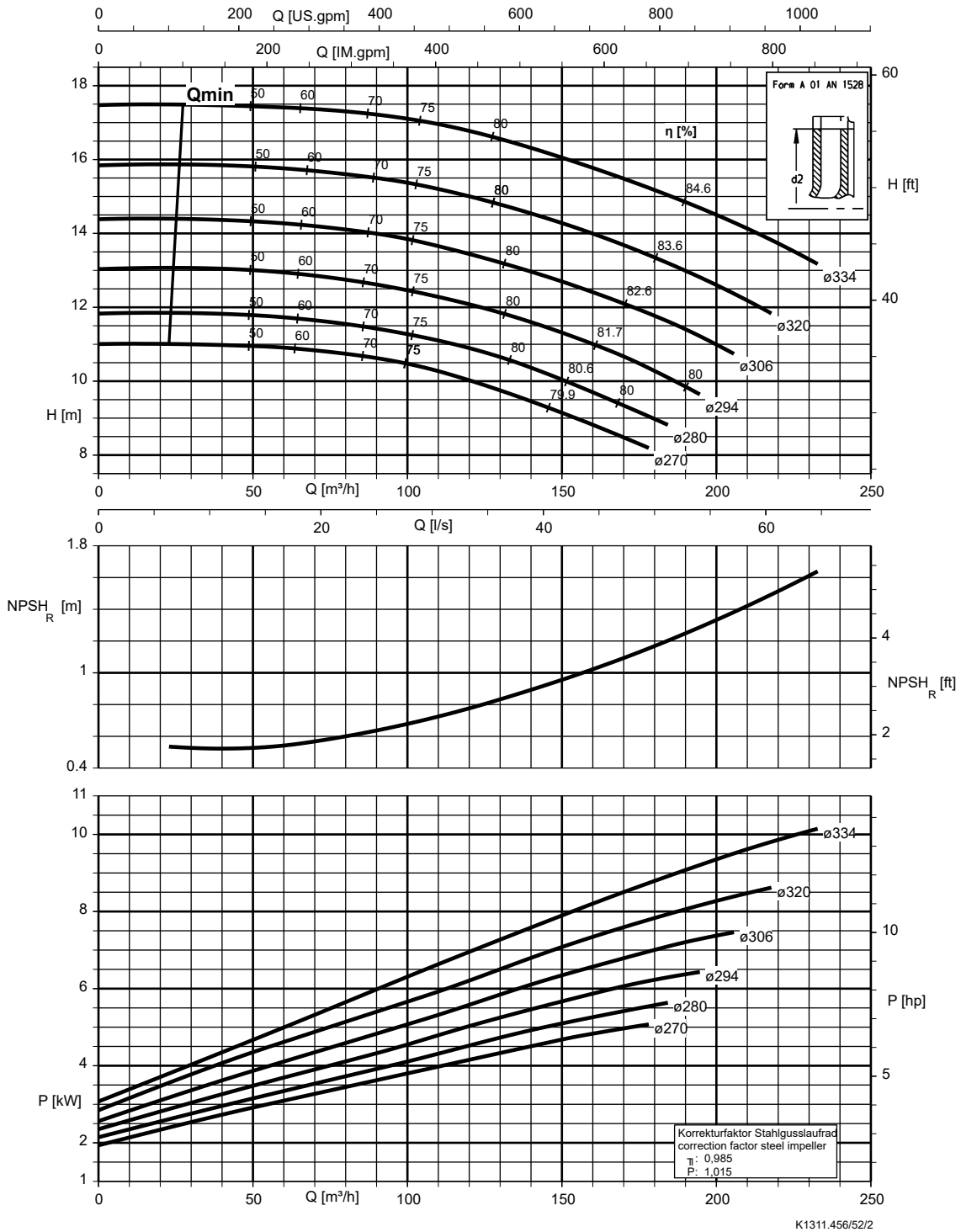

Vlet 150-125-400, n = 960 rpm

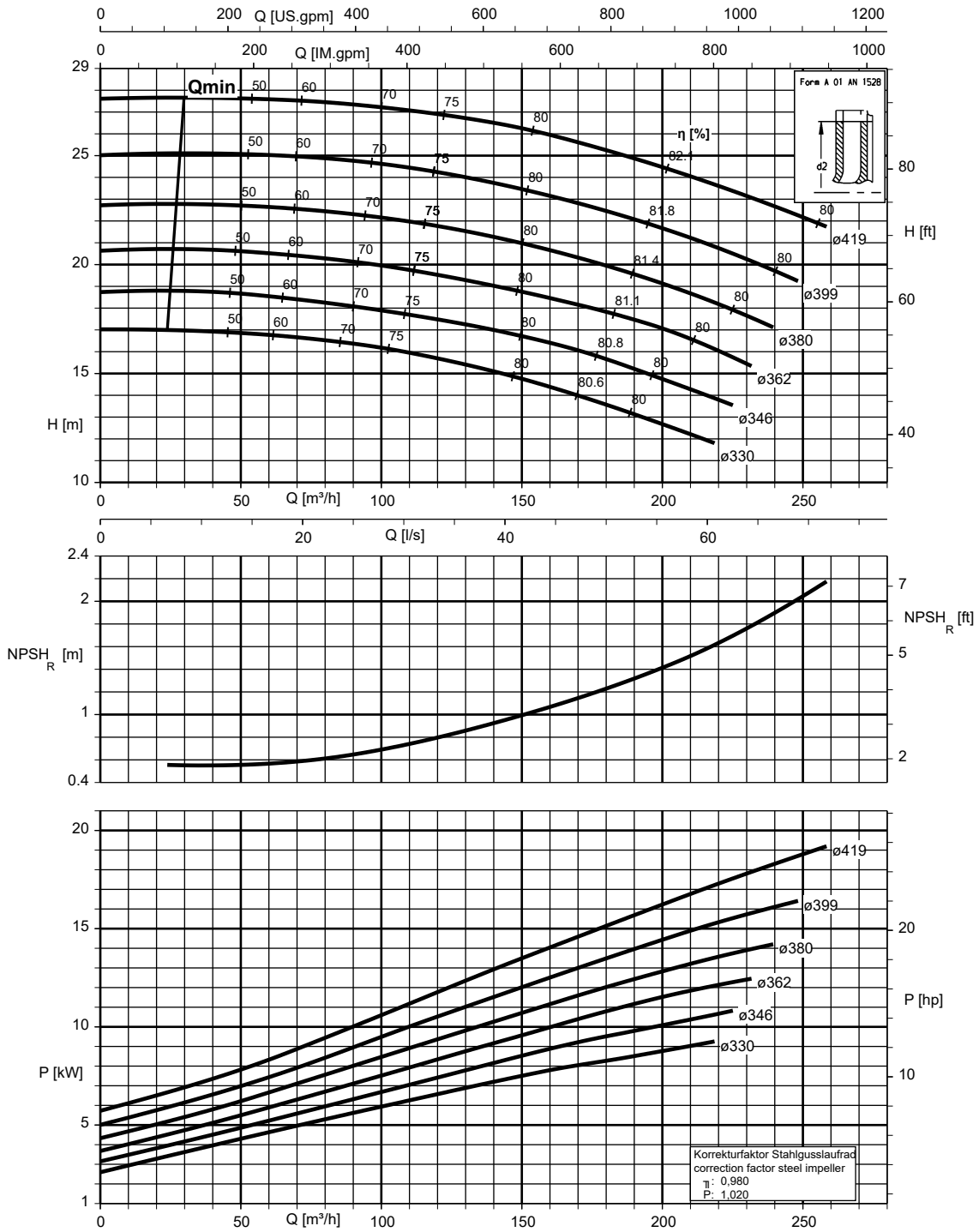

K1311.456/53/2

Vlet 150-125-510, n = 960 rpm

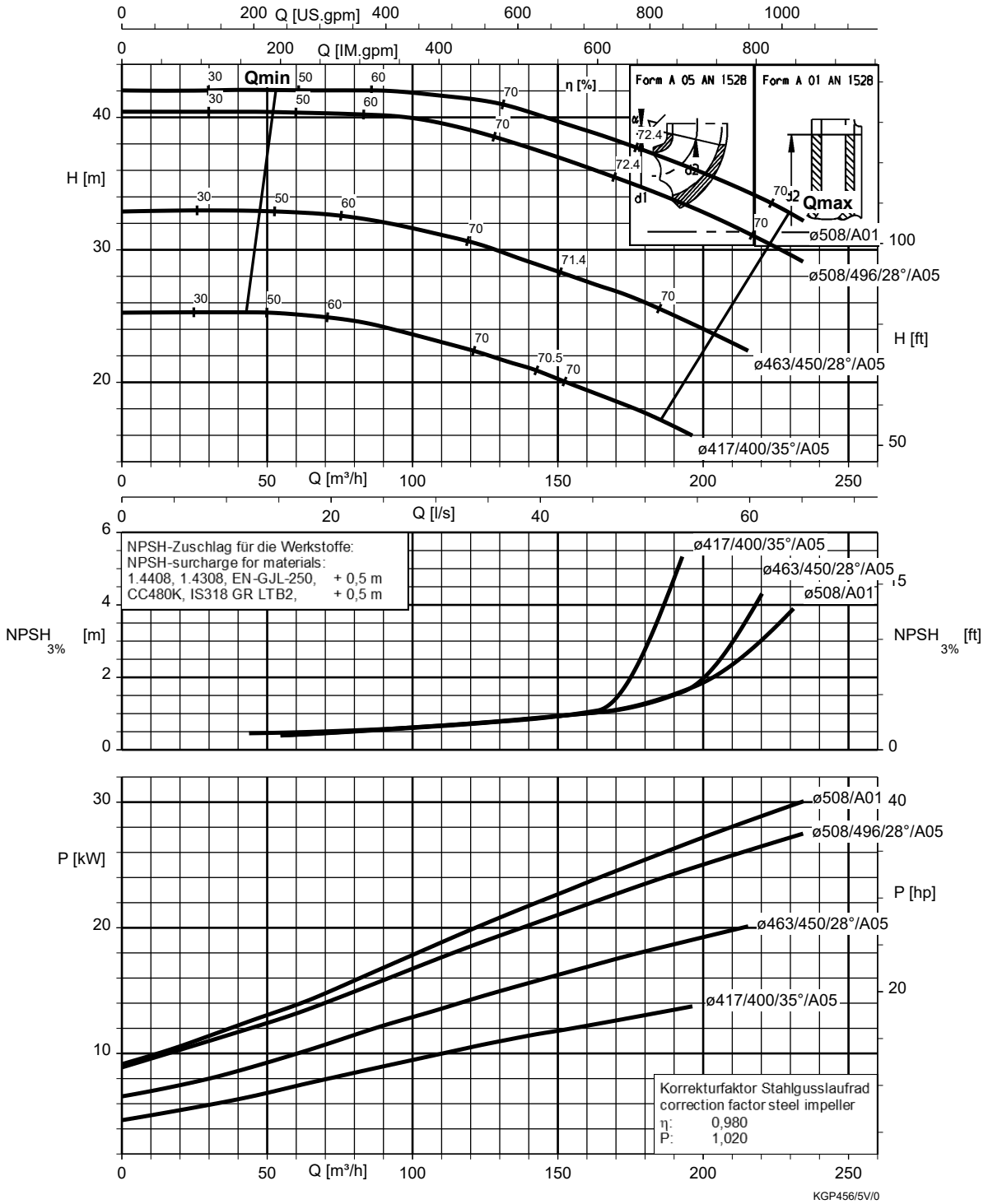

Vlet 200-150-200, n = 960 rpm

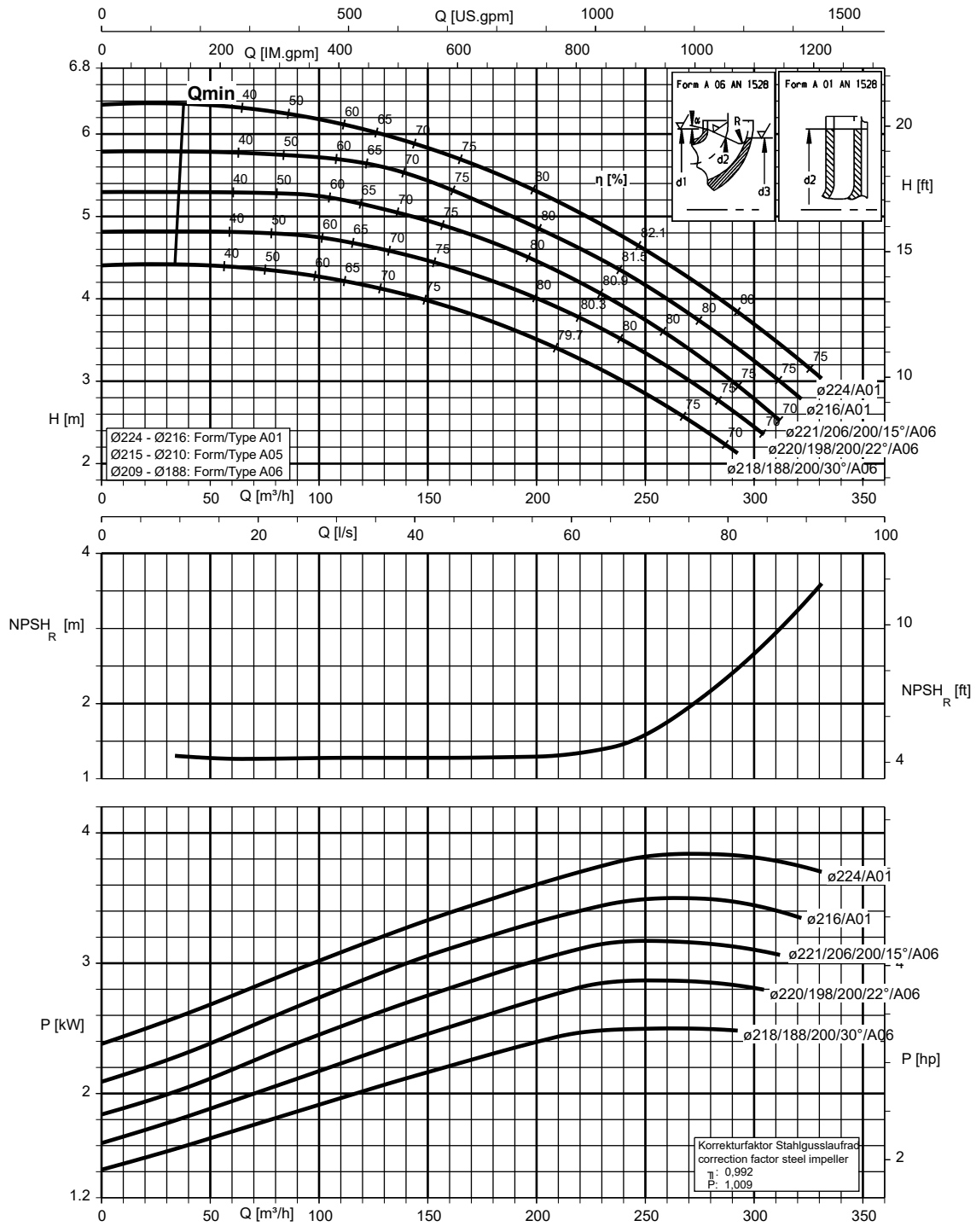

Vlet 200-150-250, n = 960 rpm

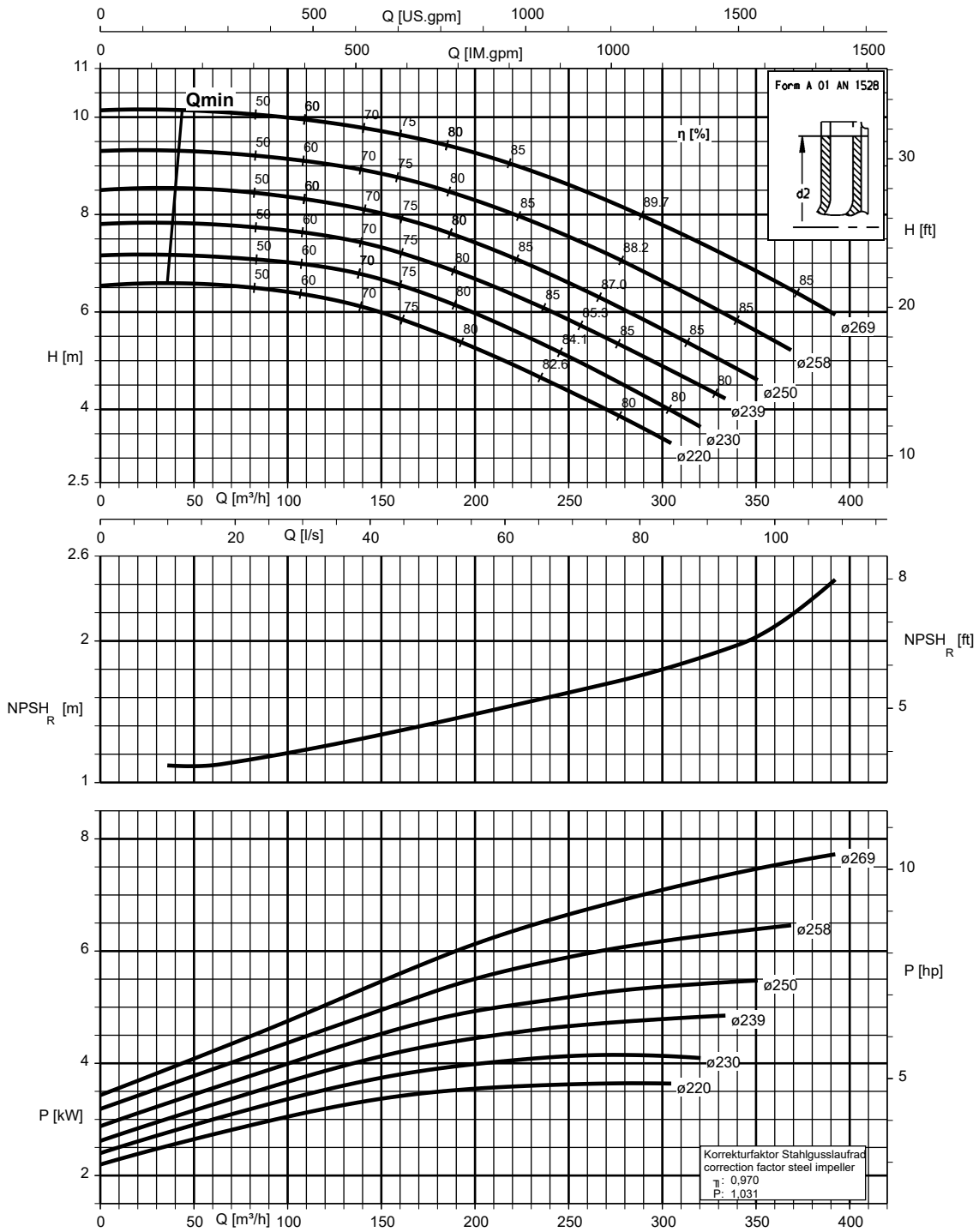

K1311.456/56/2

Vlet 200-150-315, n = 960 rpm

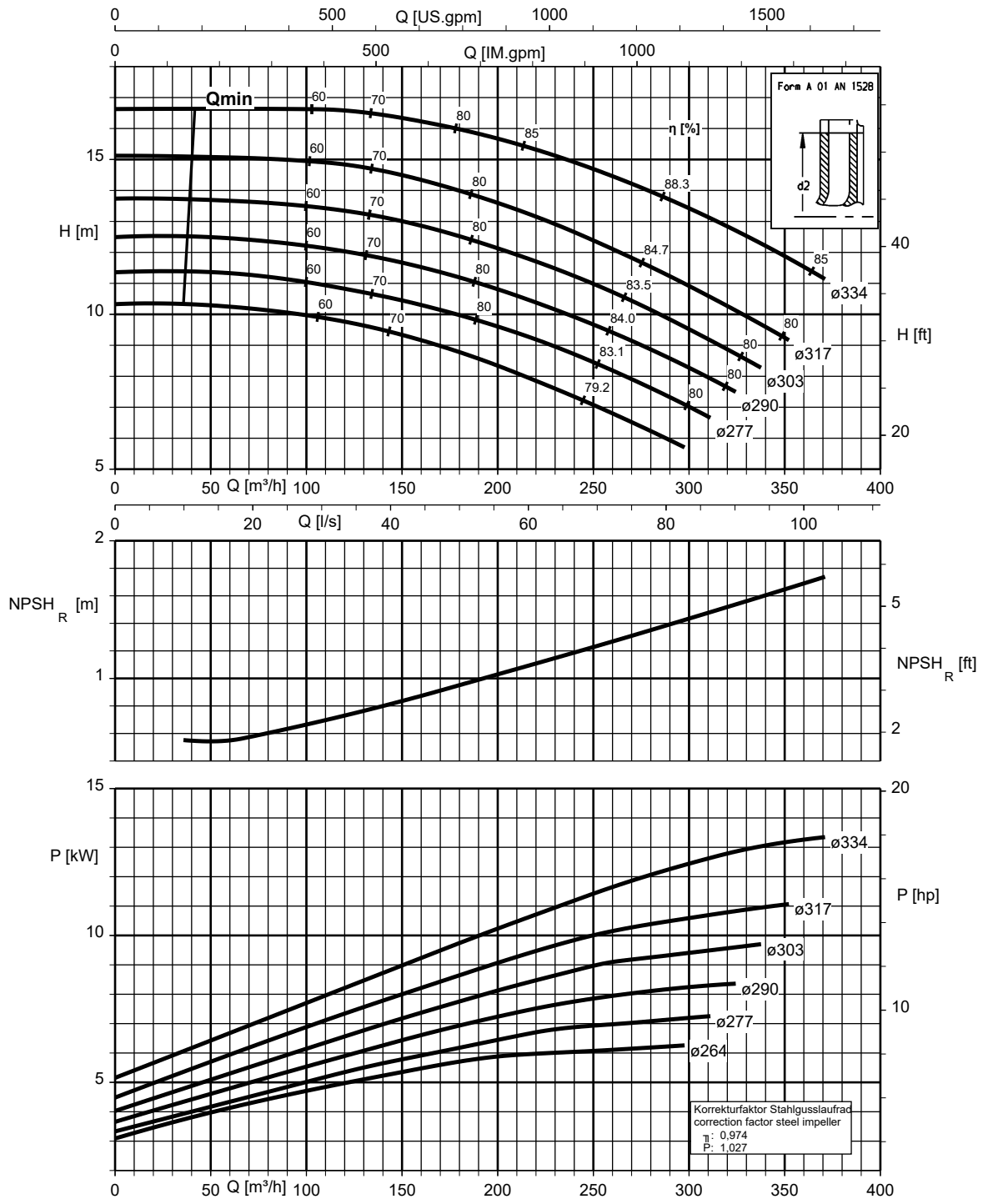

Vlet 200-150-400, n = 960 rpm

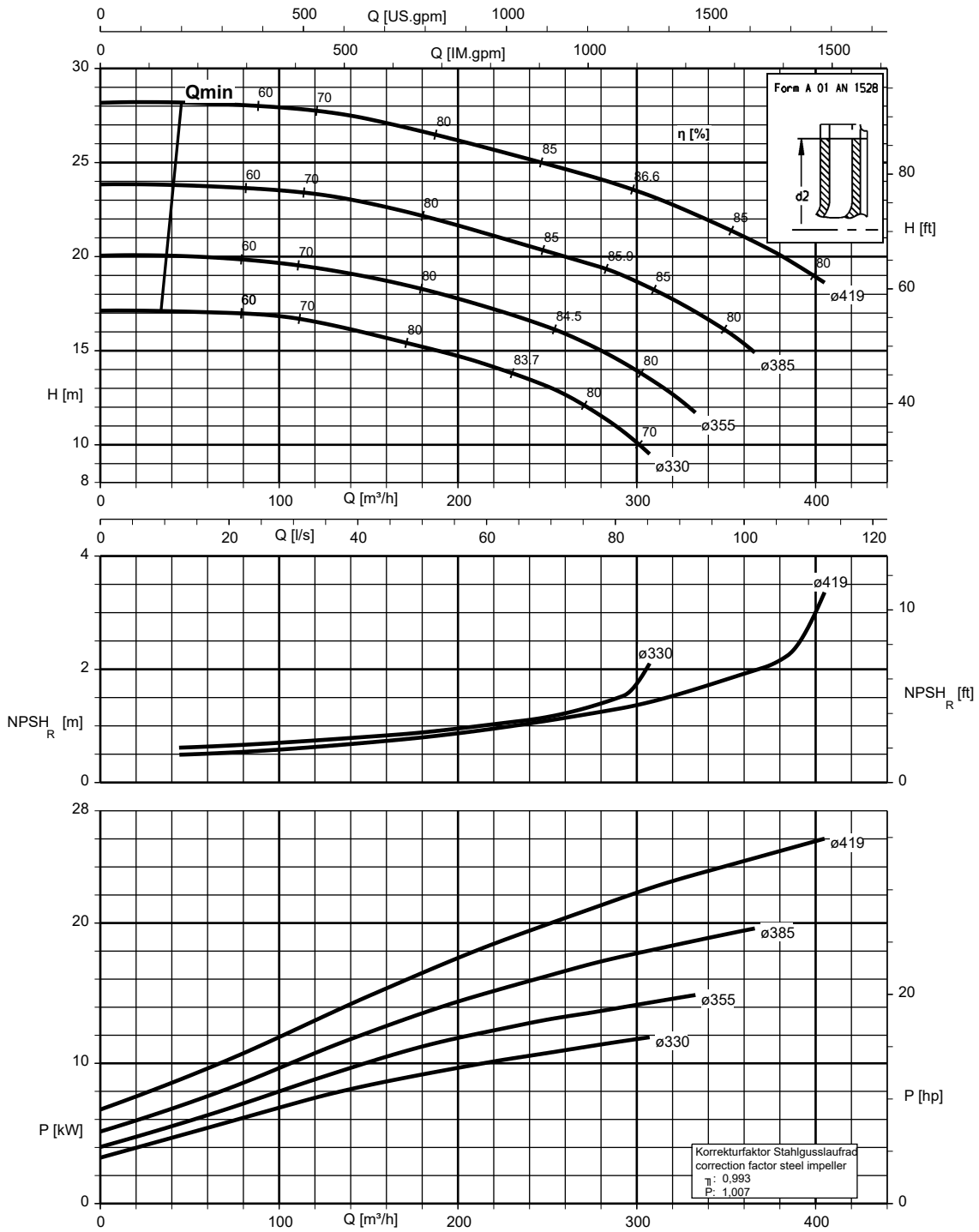

K1311.456/58/1

Vlet 200-150-510, n = 960 rpm

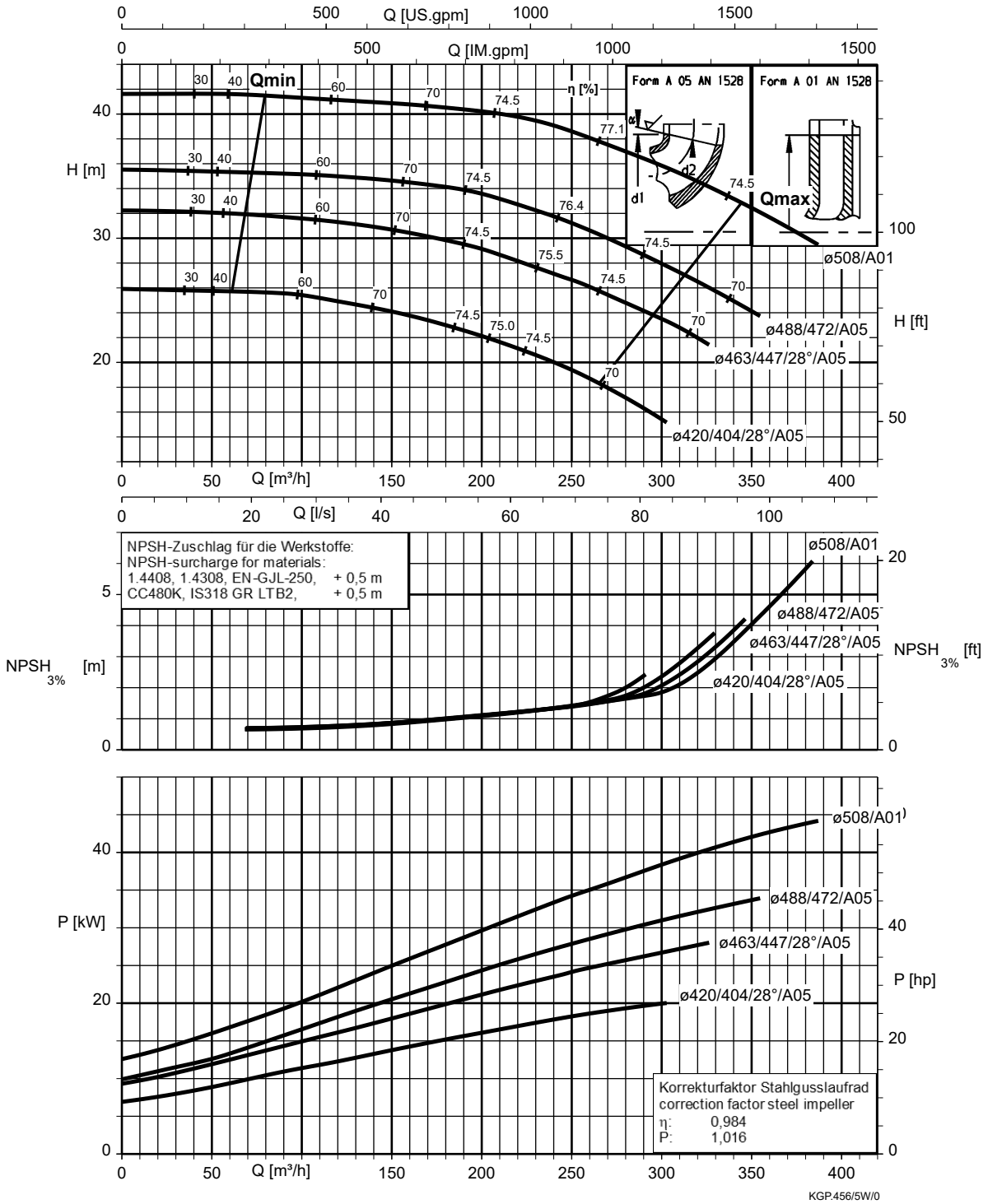

Vlet 200-200-250, n = 960 rpm

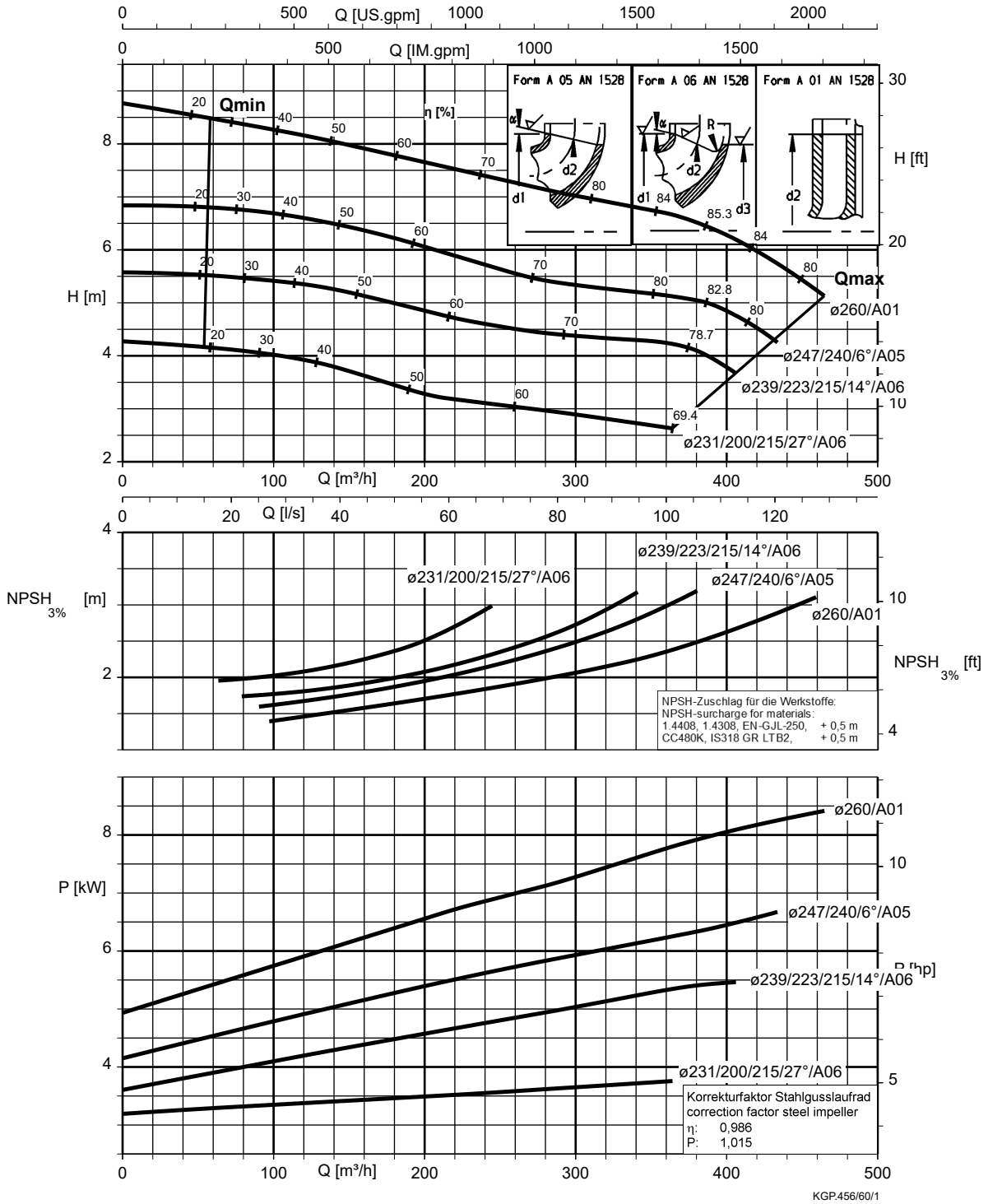

Vlet 250-200-275, n = 960 rpm

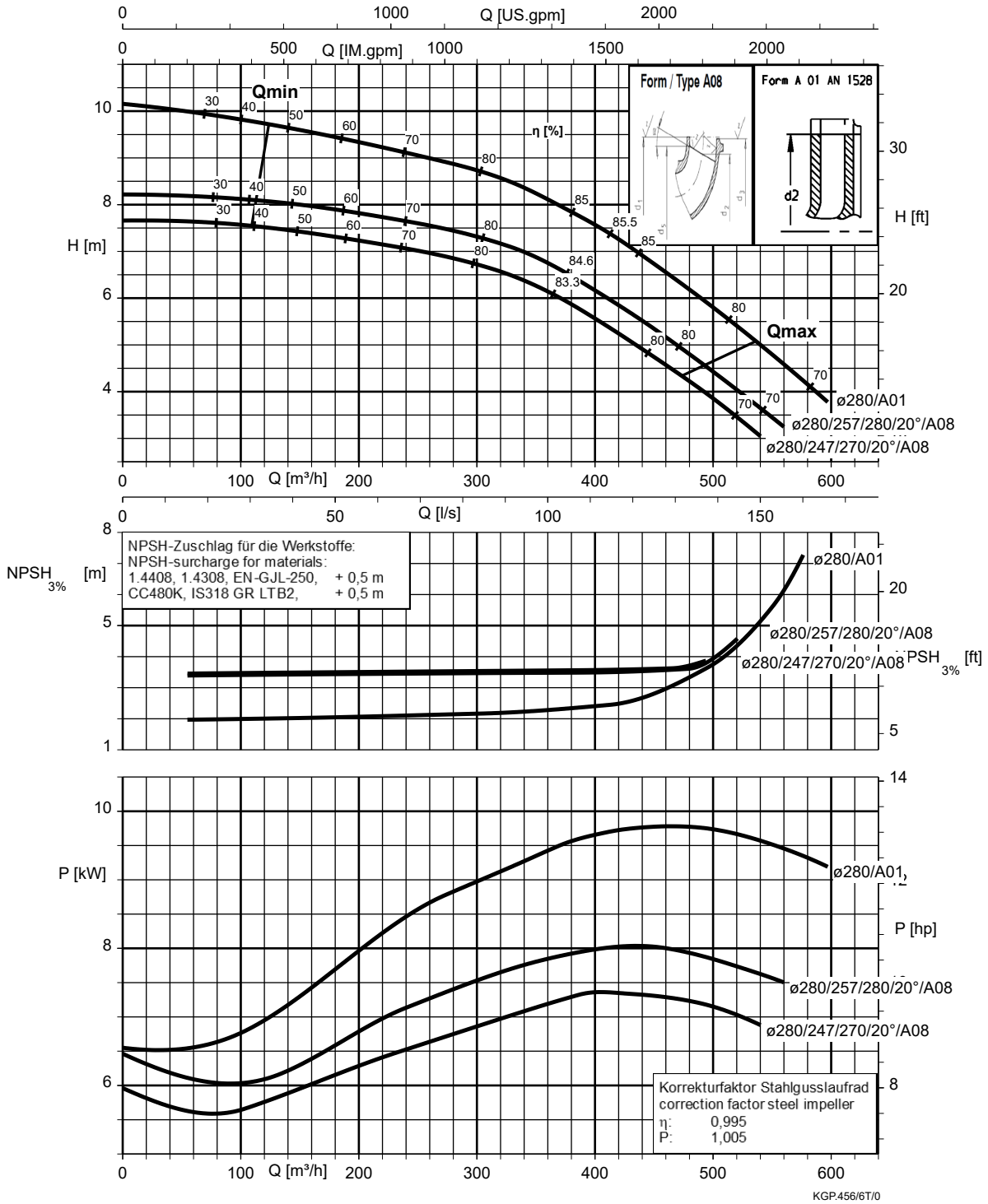

Vlet 250-200-320, n = 960 rpm

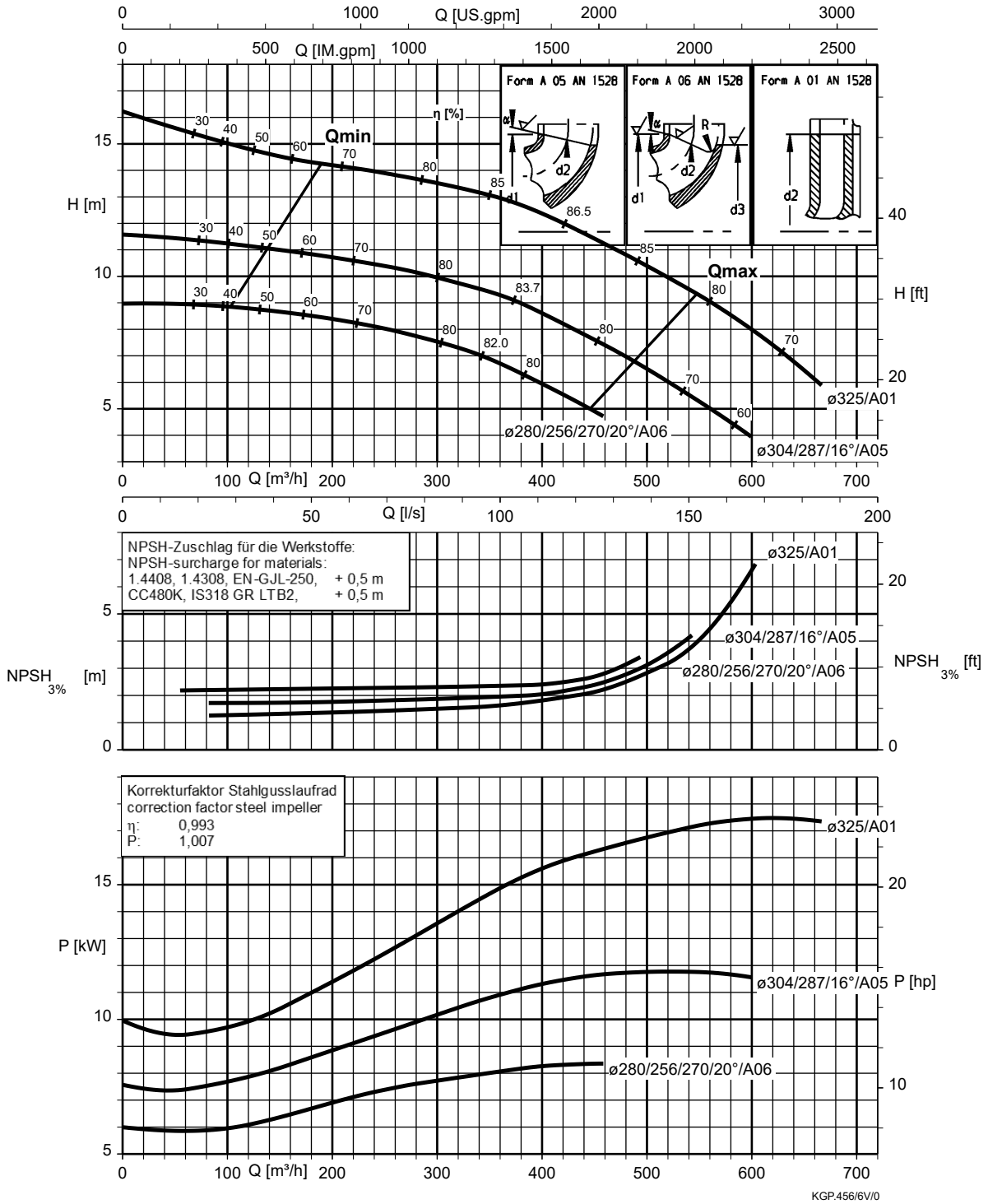

Vlet 250-200-375, n = 960 rpm

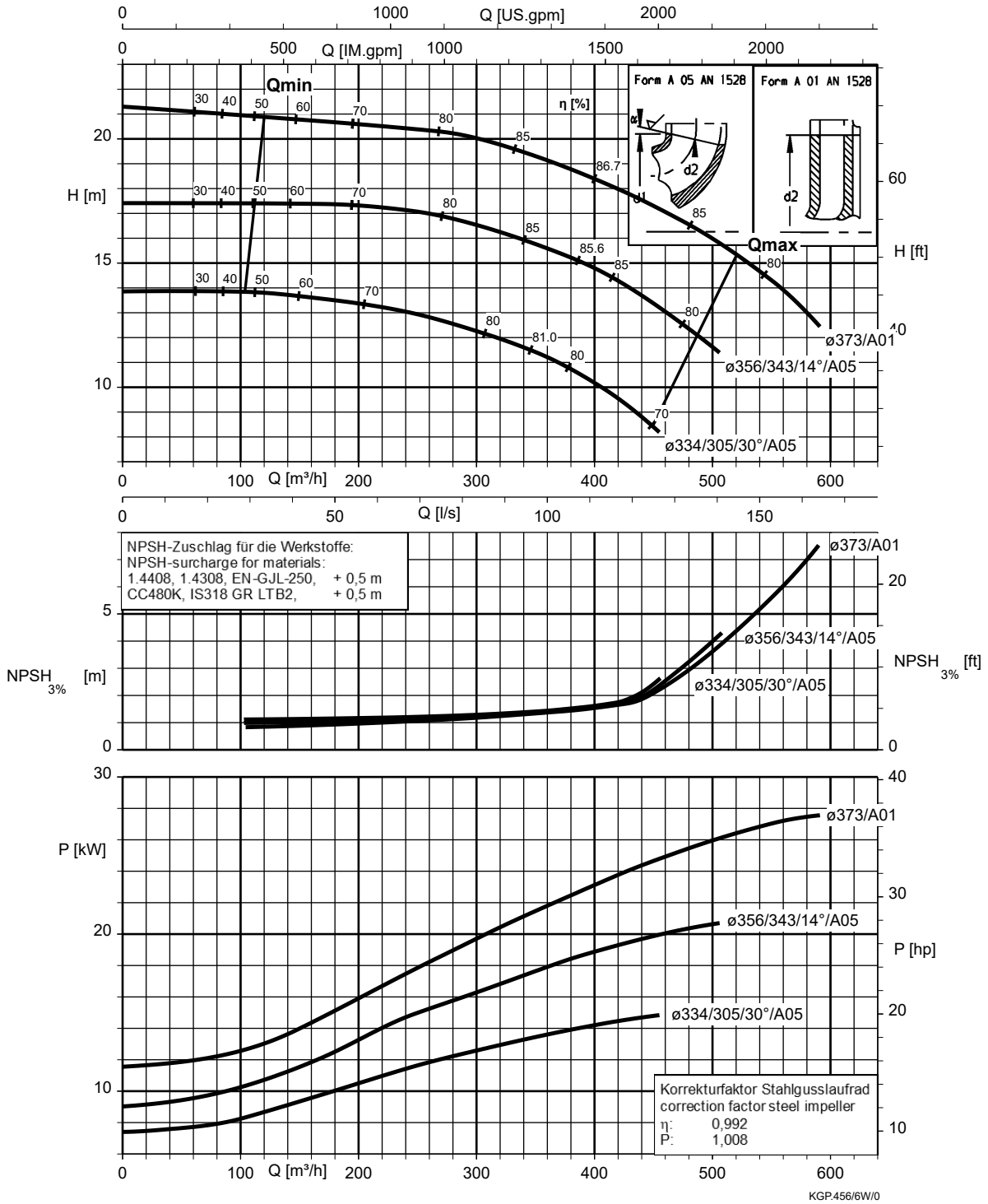

Vlet 250-200-435, n = 960 rpm

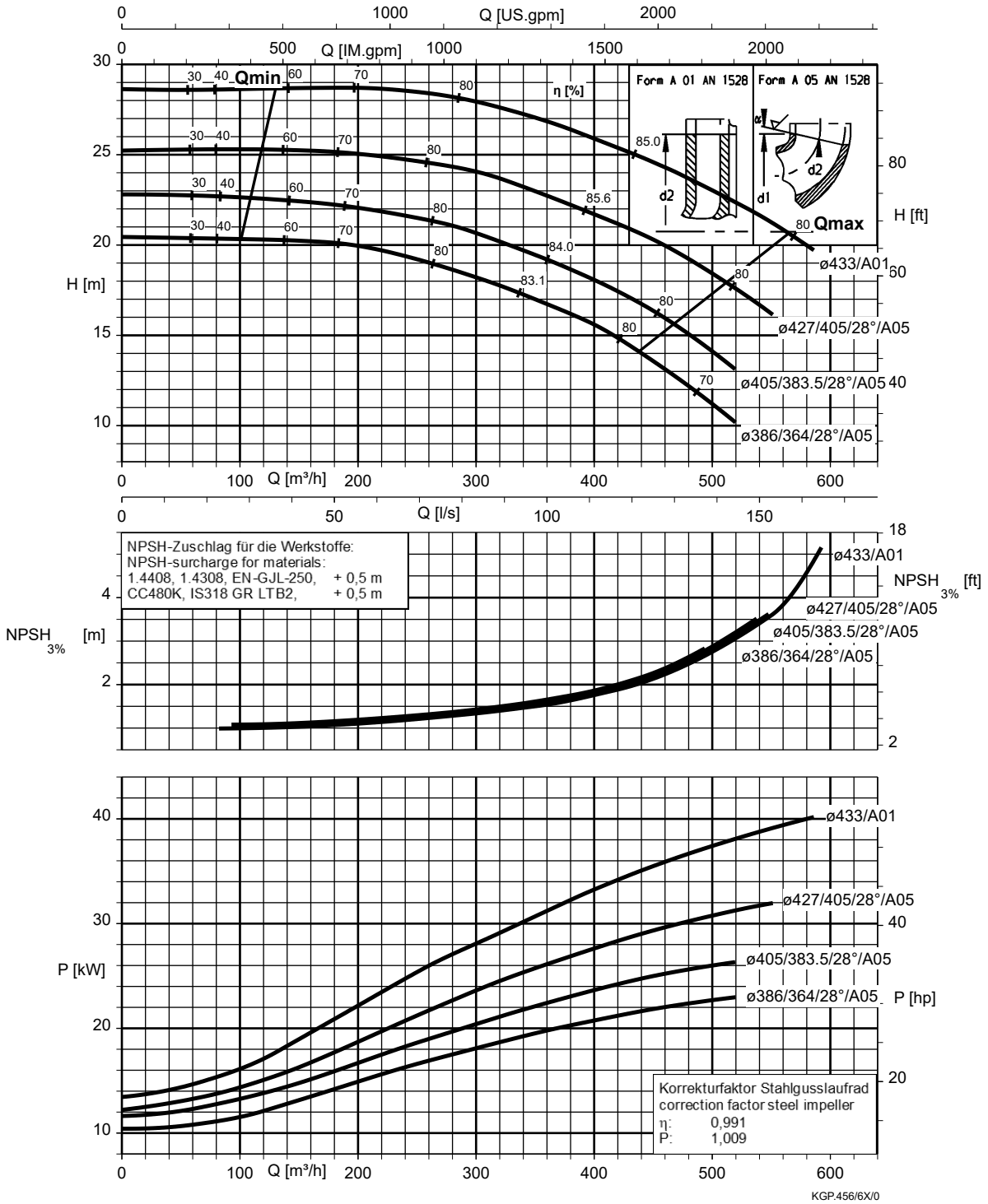

Vlet 250-200-510, n = 960 rpm

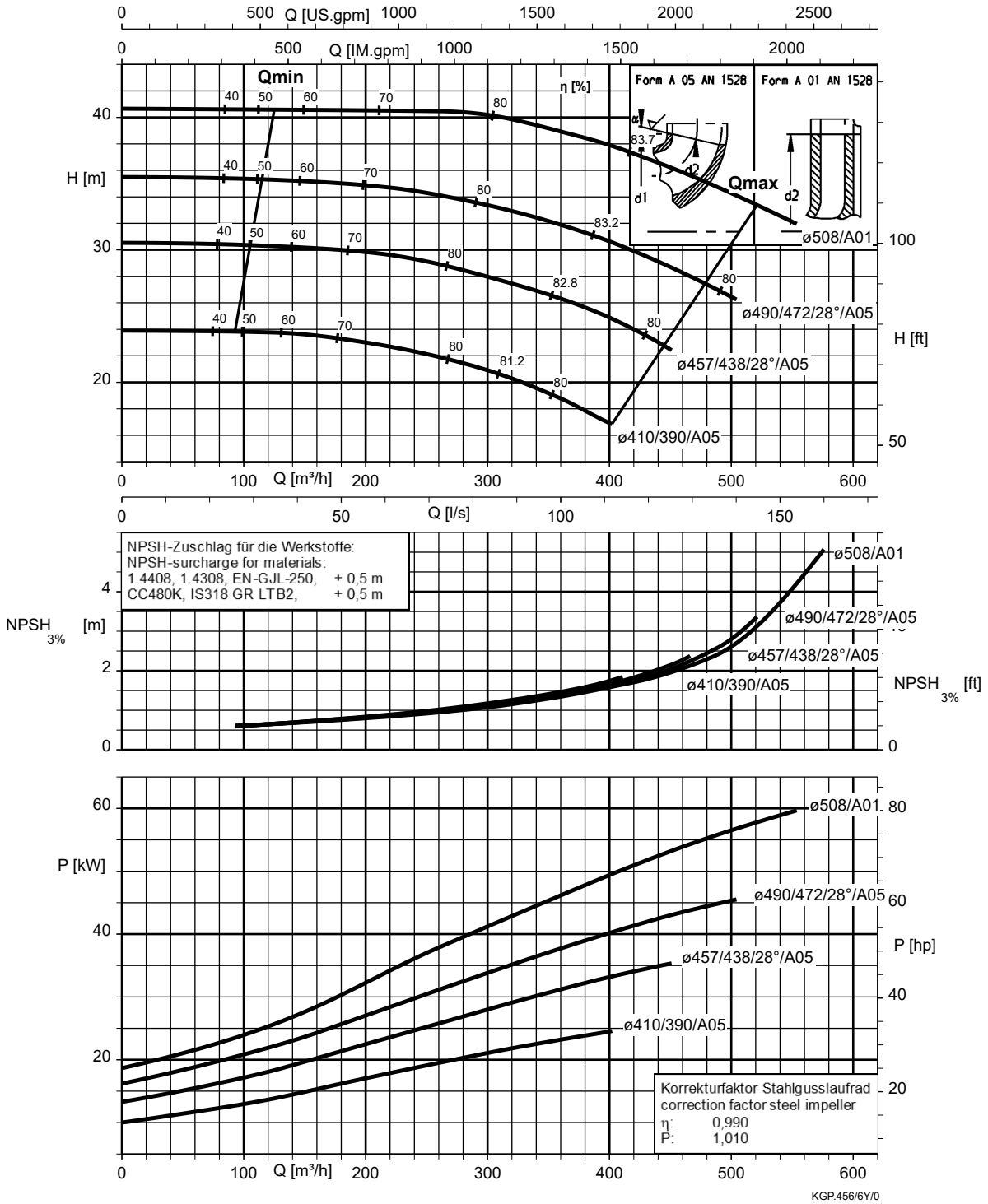

Vlet 300-250-295, n = 960 rpm

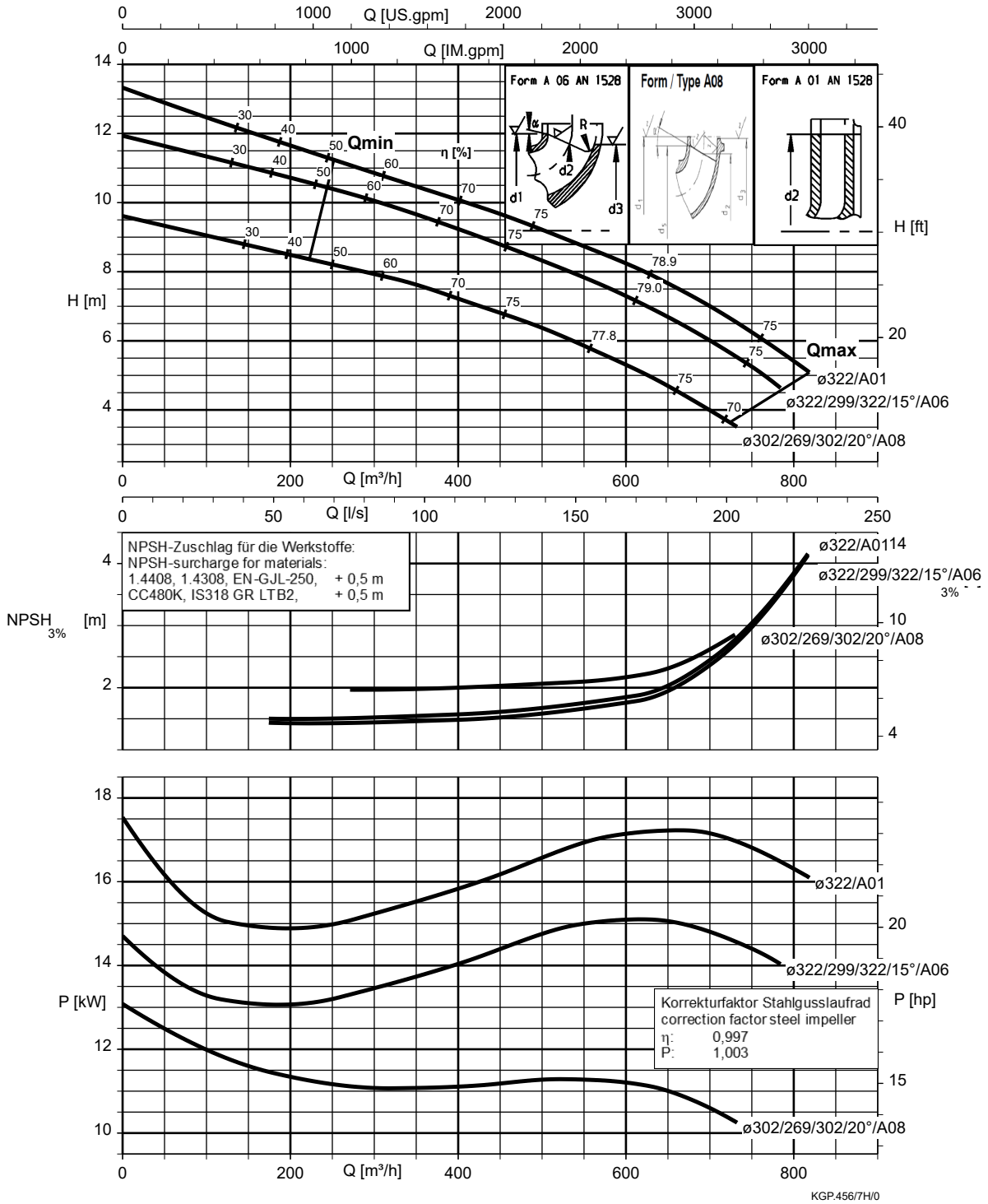

Vlet 300-250-295.1 , n = 960 rpm

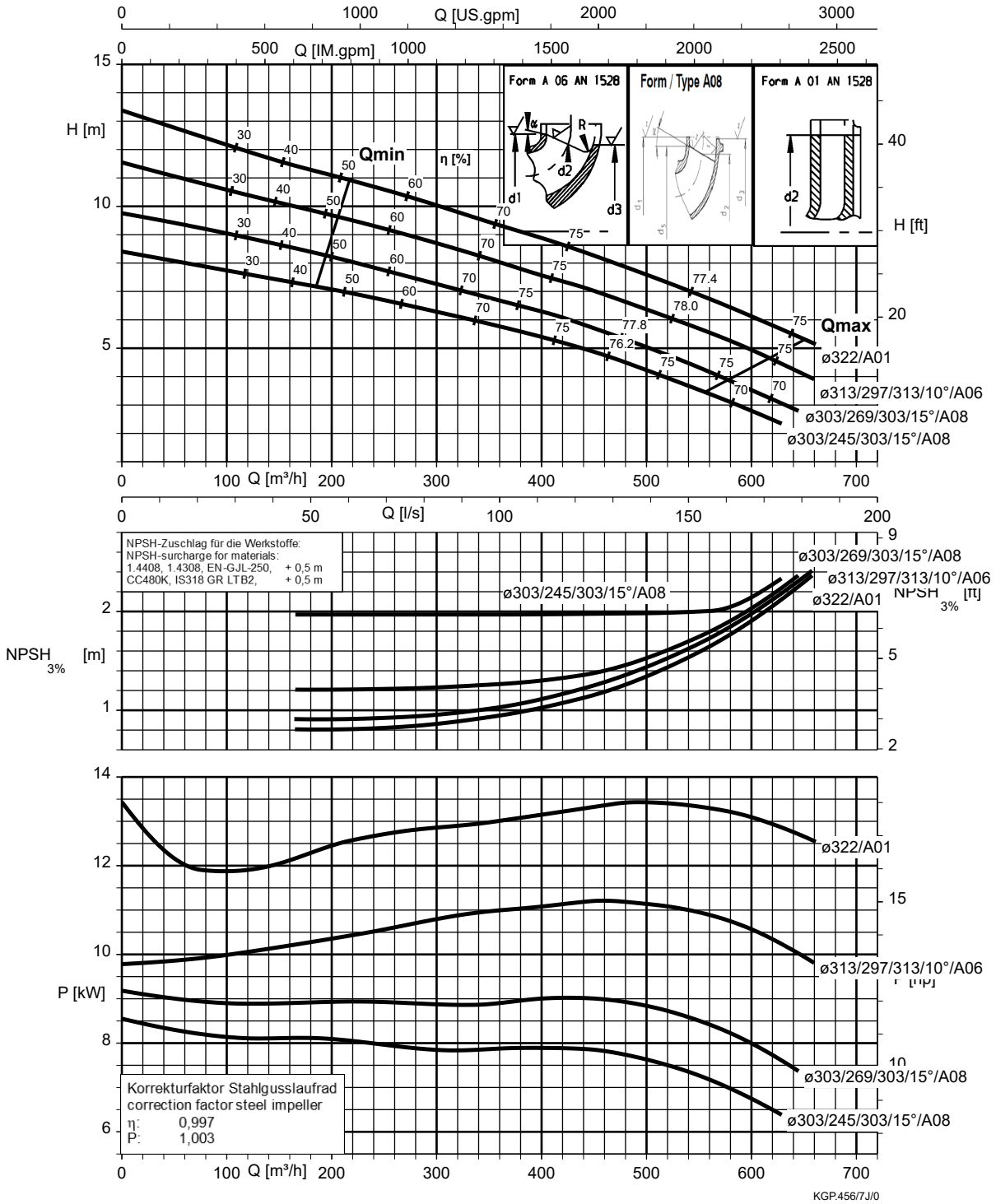

Vlet 300-250-320, n = 960 rpm

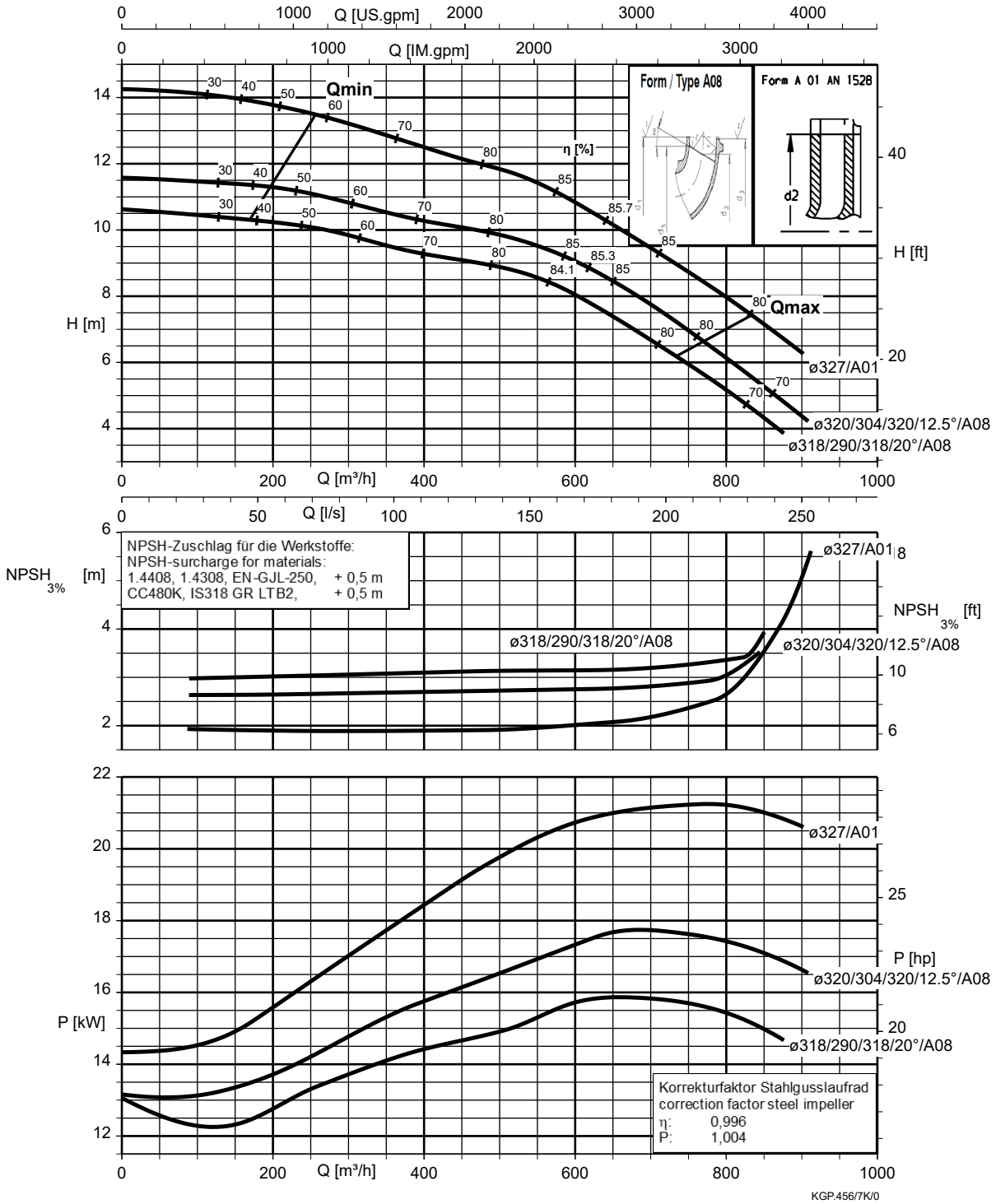

Vlet 300-250-375, n = 960 rpm

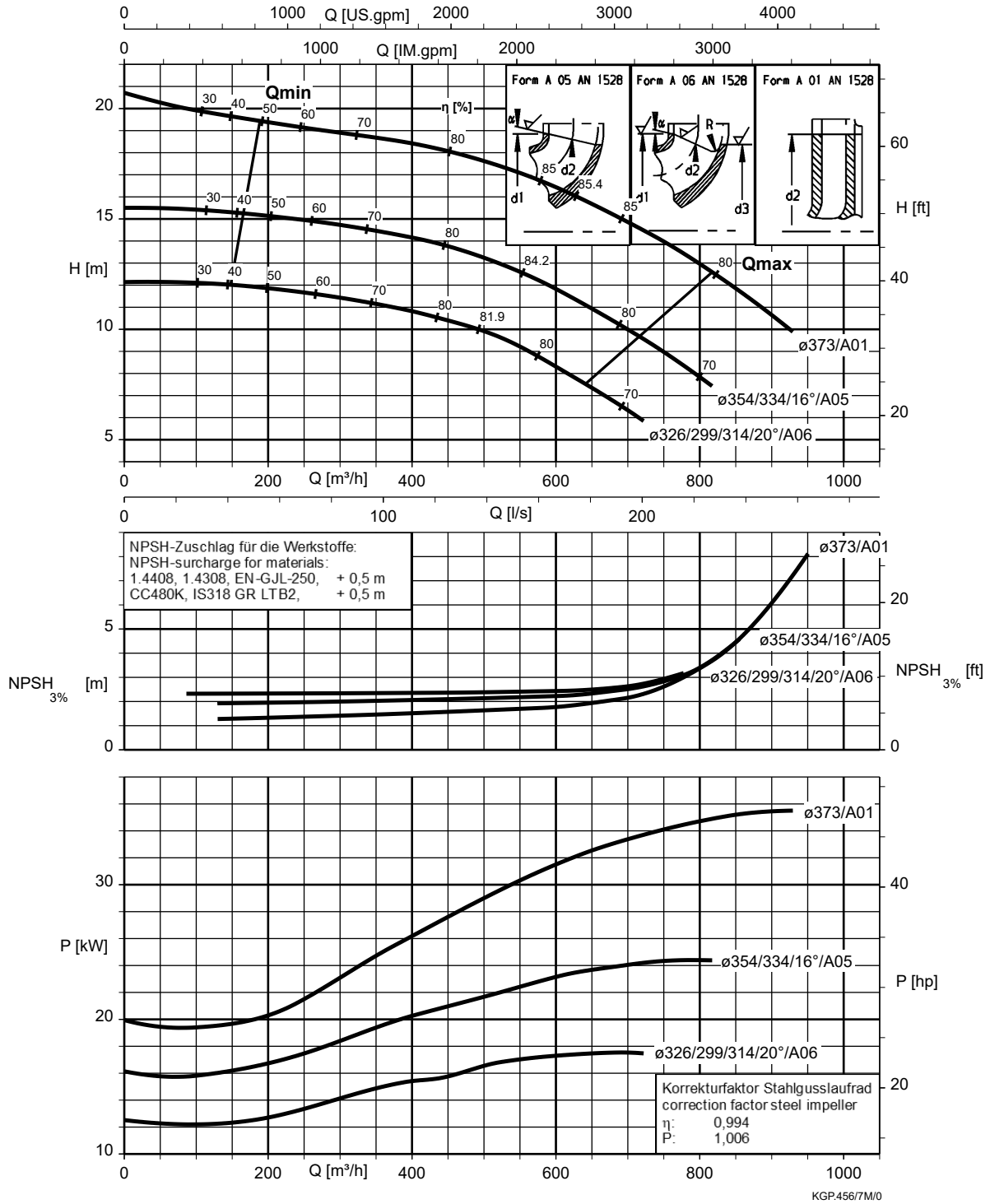

Vlet 300-250-435, n = 960 rpm

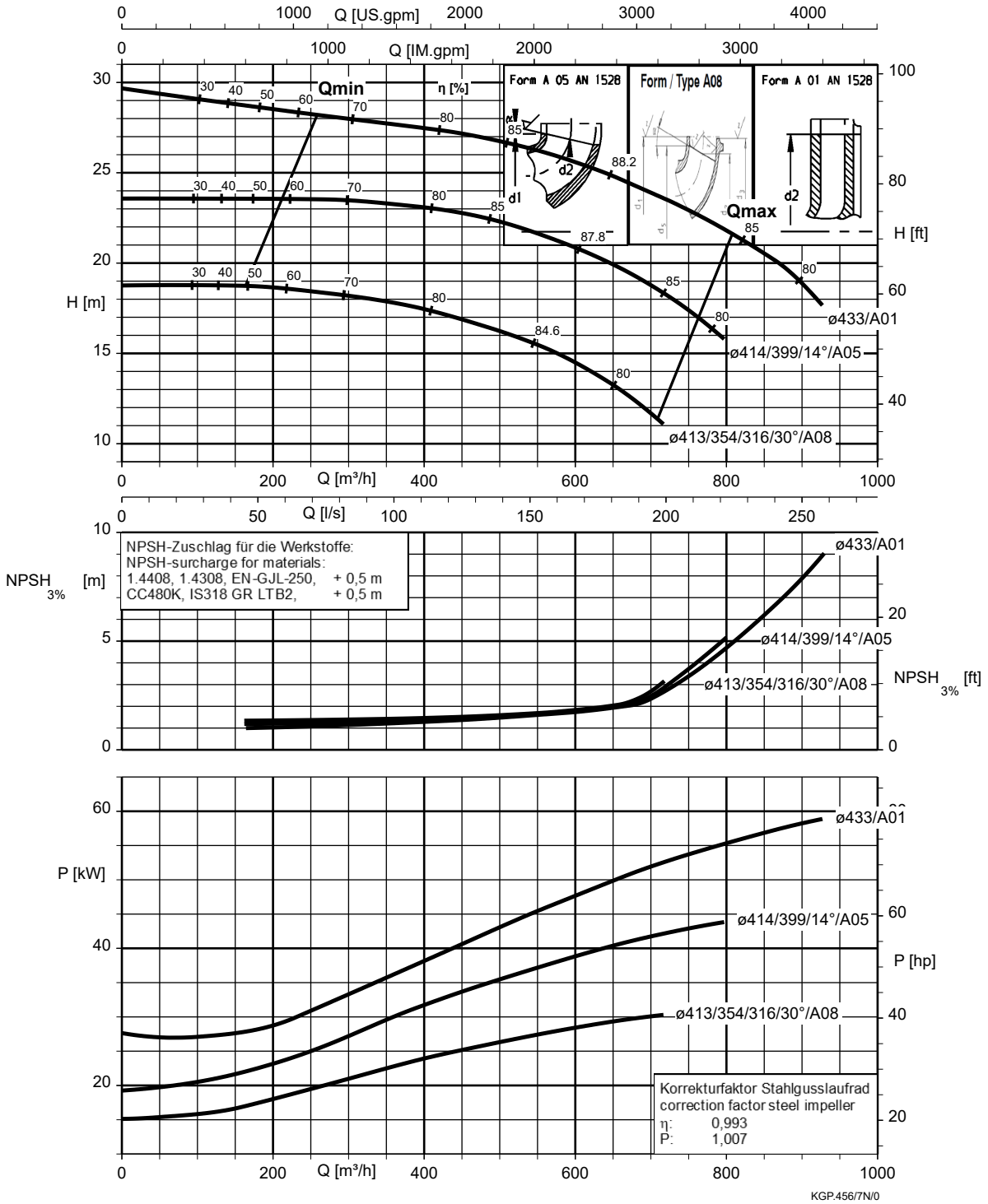

Vlet 300-250-510, n = 960 rpm

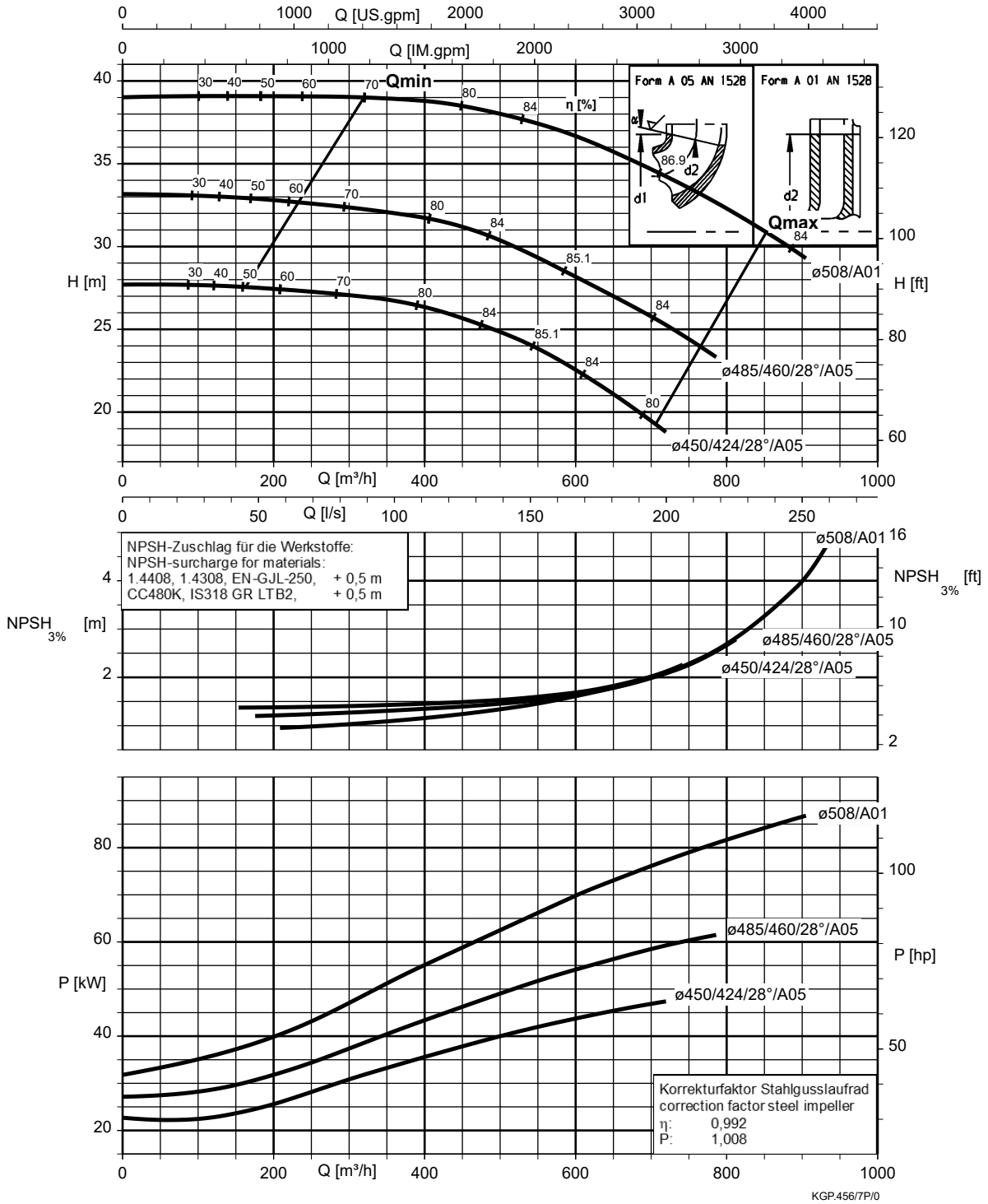

Vlet 350-300-350, n = 960 rpm

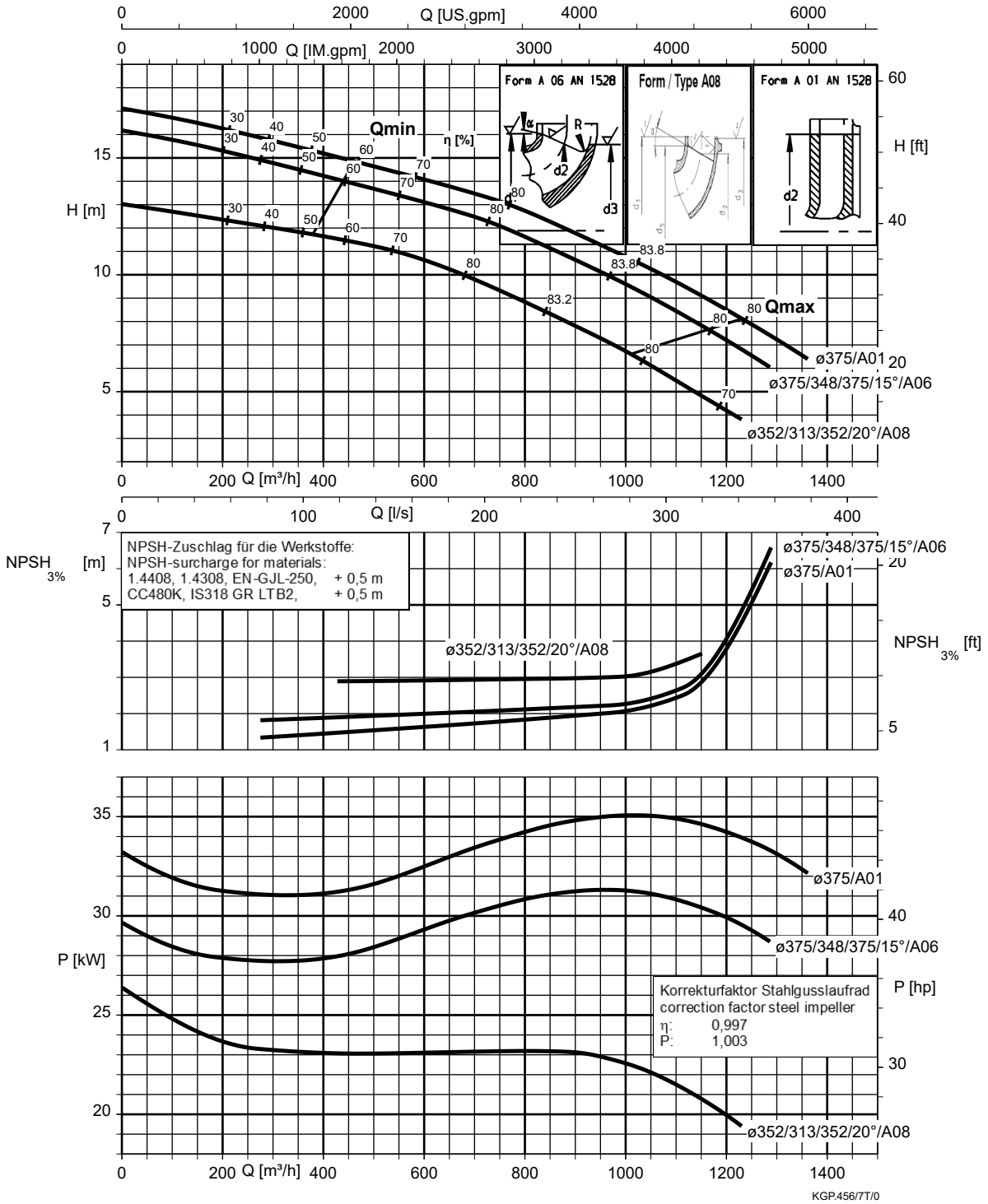

Vlet 350-300-350.1 , n = 960 rpm

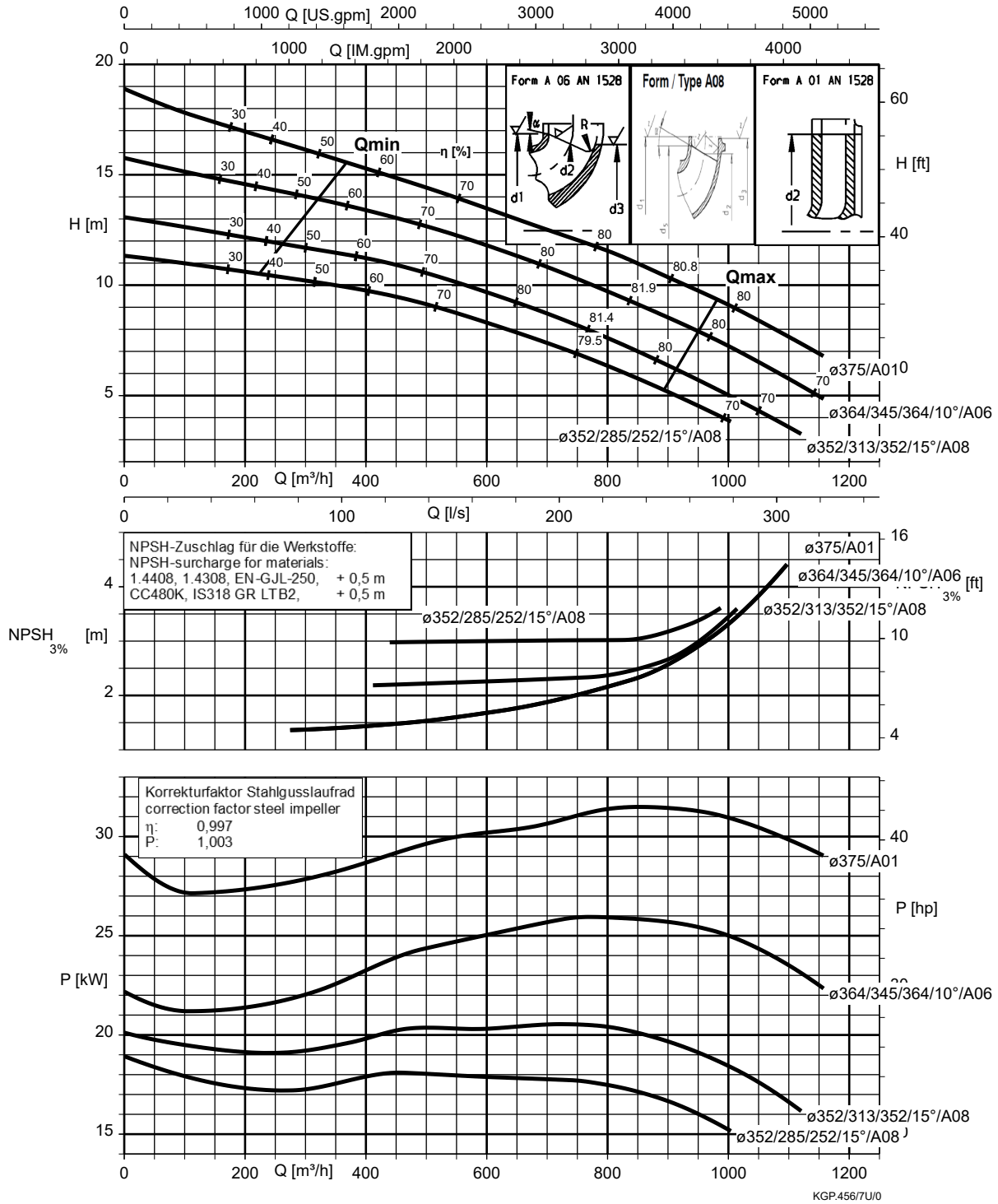

Vlet 350-300-375, n = 960 rpm

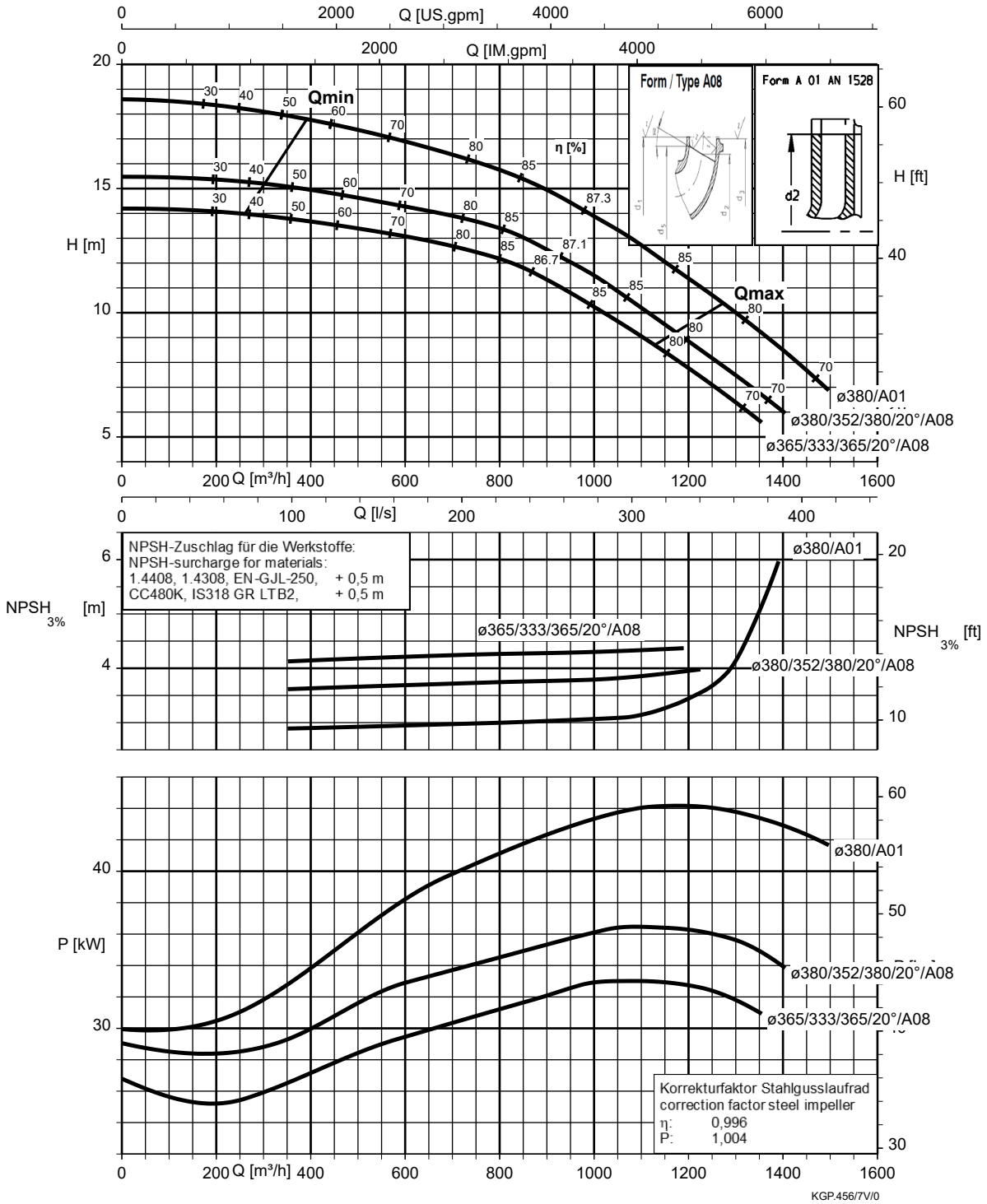

Vlet 350-300-435, n = 960 rpm

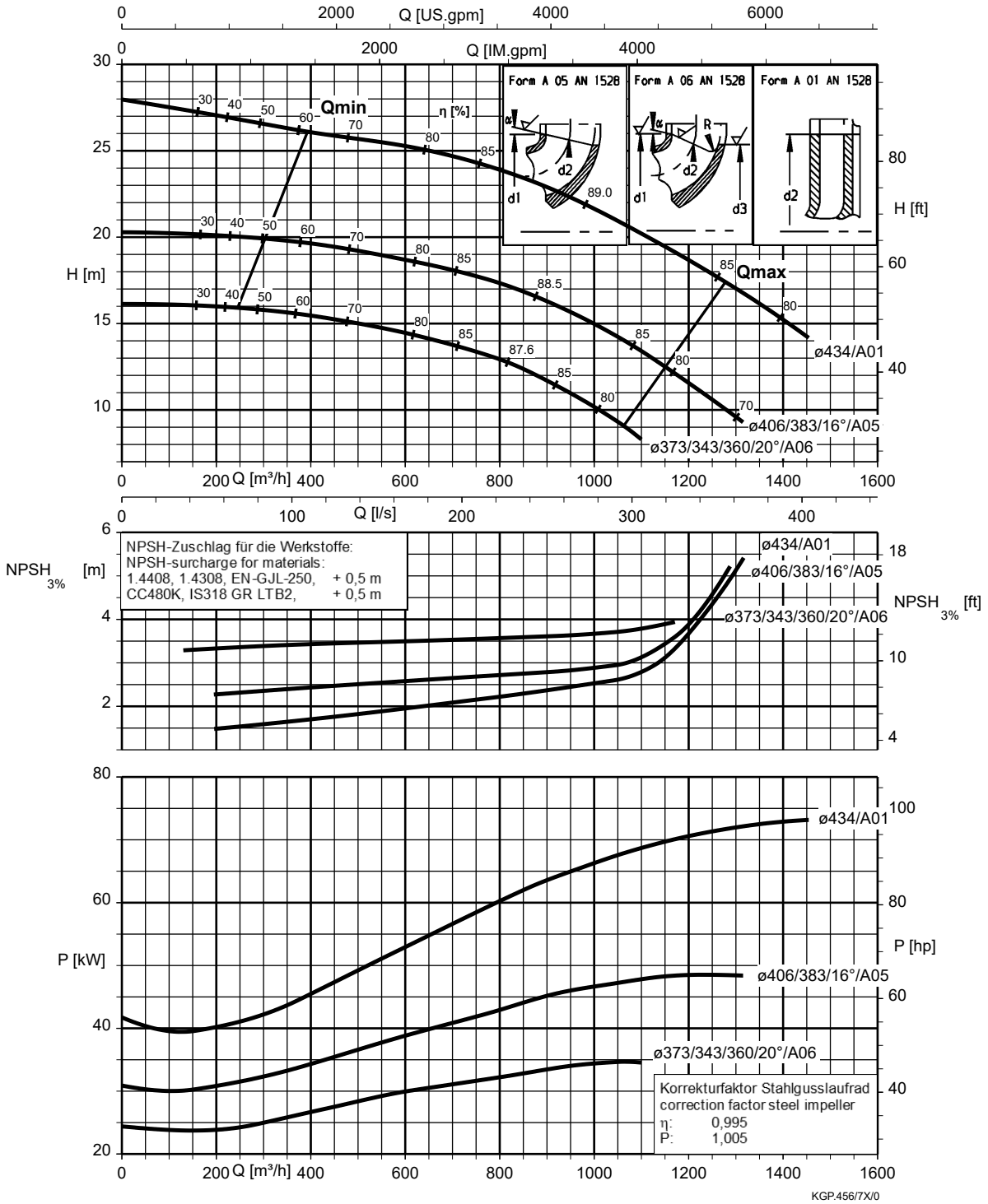

Vlet 350-300-510, n = 960 rpm

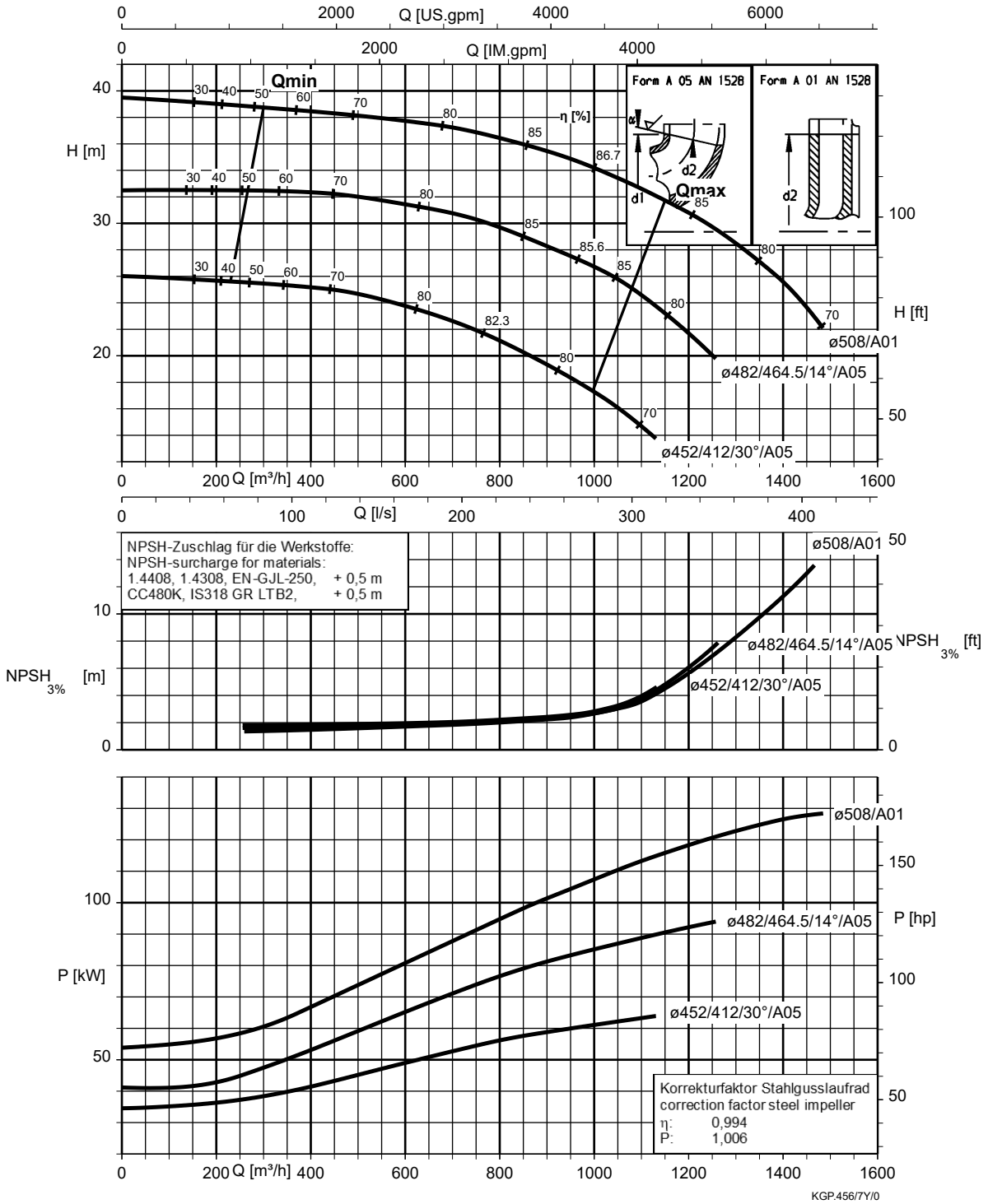

DIMENSIONS - PUMP BARE SHAFT OUTLINE DRAWING

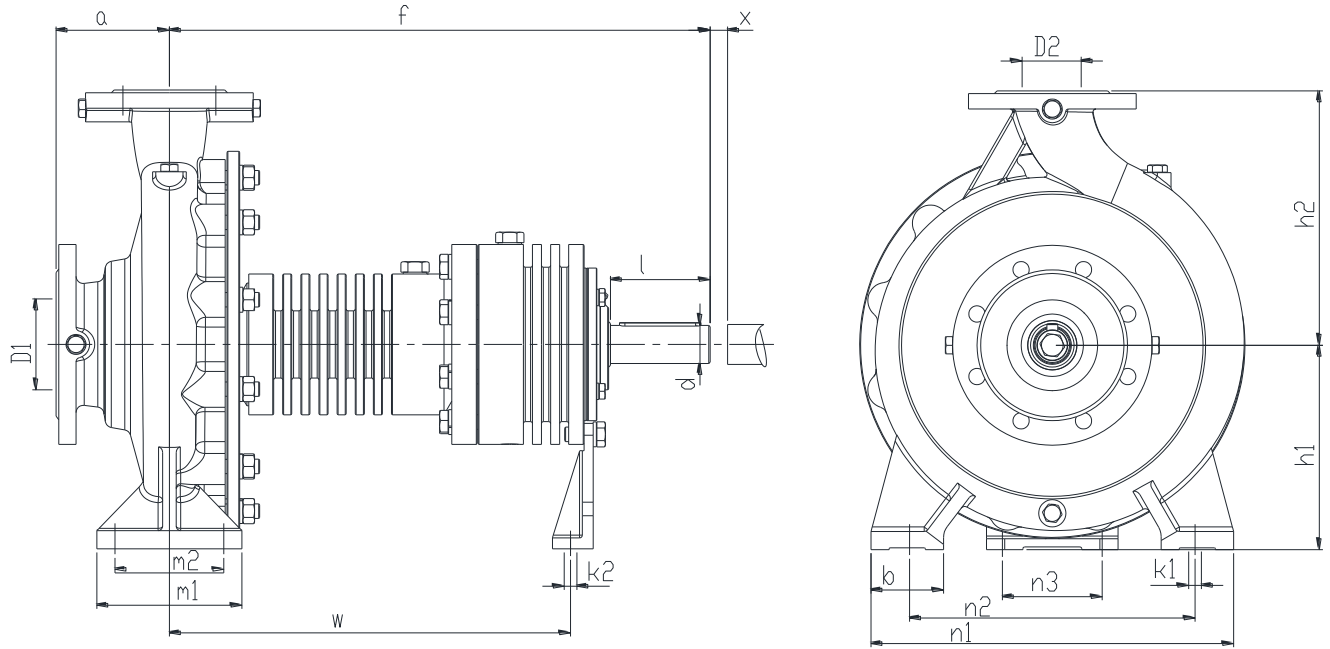

SIZE	Dimensions (mm)																	
	D1	D2	a	f	h1	h2	b	m1	m2	n1	n2	n3	w	x	d	l	k1	k2
32-125	50	32	80	485	112	140	50	100	70	190	140	110	285	100	24	50	M12	M12
32-160	50	32	80	485	132	160	50	100	70	240	190	140	285	100	24	50	M12	M12
32-200	50	32	80	485	160	180	50	100	70	240	190	140	285	100	24	50	M12	M12
32-250	50	32	100	600	180	225	65	125	95	320	250	190	370	100	32	80	M12	M12
40-160	65	40	80	485	132	160	50	100	70	240	190	140	285	100	24	50	M12	M12
40-200	65	40	100	485	160	180	50	100	70	265	212	165	285	100	24	50	M12	M12
40-250	65	40	100	600	180	225	65	125	95	320	250	190	370	100	32	80	M12	M12
40-315	65	40	125	600	200	250	65	125	95	345	280	215	370	100	32	80	M12	M12
50-160	80	50	100	485	160	180	50	100	70	265	212	165	285	100	24	50	M12	M12
50-200	80	50	100	485	160	200	50	100	70	265	212	165	285	100	24	50	M12	M12
50-250	80	50	125	600	180	225	65	125	95	320	250	190	370	100	32	80	M12	M12
50-315	80	50	125	600	225	280	65	125	95	345	280	215	370	100	32	80	M12	M12
65-160	100	65	100	600	160	200	65	125	95	280	212	150	370	100	32	80	M12	M12
65-200	100	65	100	600	180	225	65	125	95	320	250	190	370	140	32	80	M12	M12
65-250	100	65	125	600	200	250	80	160	120	360	280	200	370	140	32	80	M16	M12
65-315	100	65	125	630	225	280	80	160	120	400	315	240	370	140	42	110	M16	M12
80-160	125	80	125	600	180	225	65	125	95	320	250	190	370	140	32	80	M12	M12
80-200	125	80	125	600	180	250	65	125	95	345	280	215	370	140	32	80	M16	M12
80-250	125	80	125	600	225	280	80	160	120	400	315	240	370	140	32	80	M16	M12
80-315	125	80	125	630	250	315	80	160	120	400	315	240	370	140	42	110	M16	M12
100-200	125	100	125	600	200	280	80	160	120	360	280	200	370	140	32	80	M16	M12
100-250	125	100	140	630	225	280	80	160	120	400	315	240	370	140	42	110	M16	M12
100-315	125	100	140	630	250	315	80	160	120	400	315	240	370	140	42	110	M16	M12
125-250	150	125	140	630	250	355	80	160	120	400	315	240	370	140	42	110	M16	M12
125-315	150	125	140	630	280	355	100	200	150	500	400	300	370	140	42	110	M20	M12

ASSEMBLY DRAWING WITH PART LIST

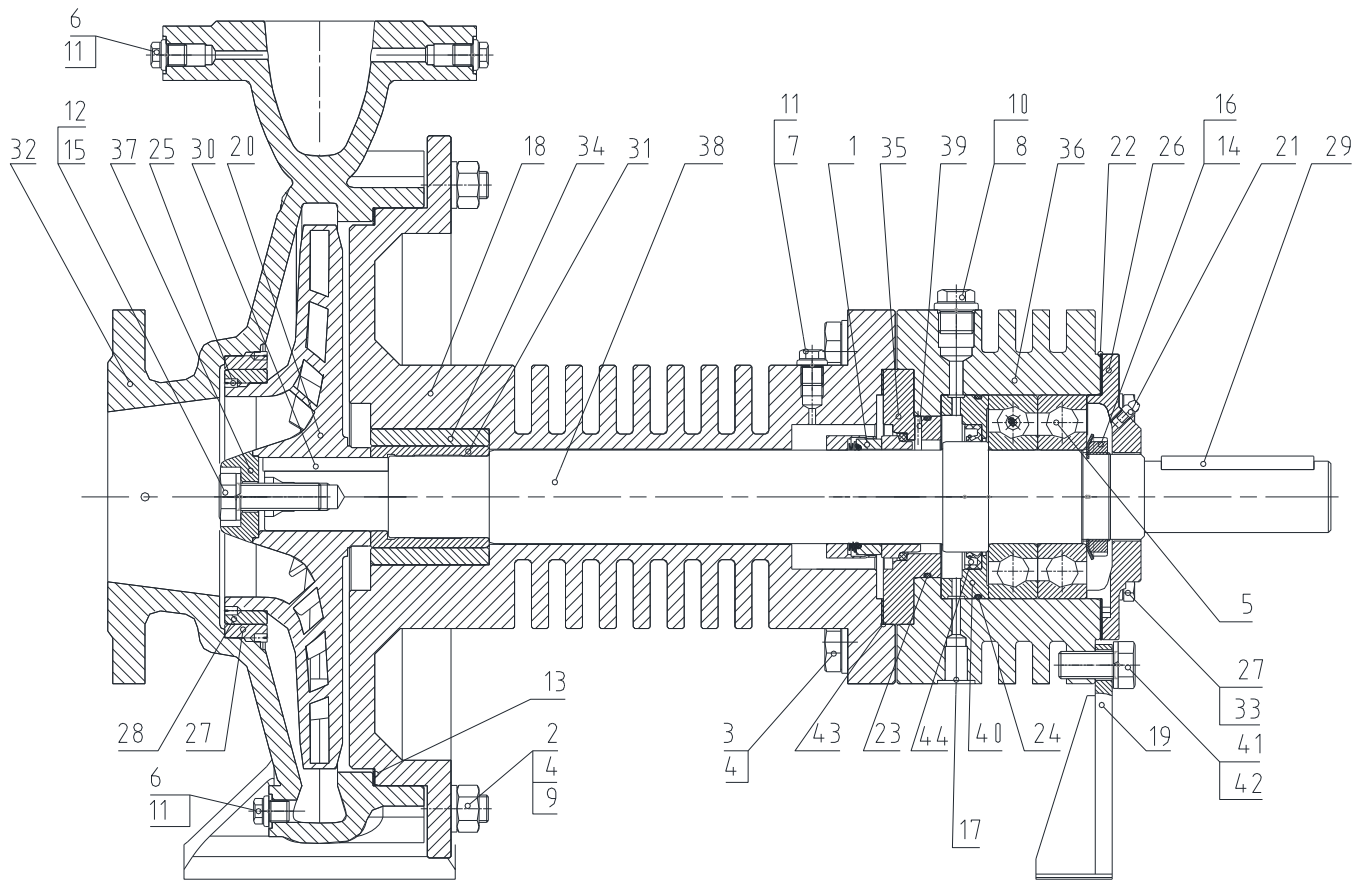

1	Mechanical seal	12	Impeller fixing screw	23	O-ring	34	Plate bearing
2	Nut	13	Gasket	24	O-ring	35	Mechanical seal cover
3	Screw	14	Lock nut	25	Screw for wearing rings fixing	36	Bearing bracket
4	Washer	15	Washer	26	Bearing cover	37	Disc
5	Ball bearings	16	Locking washer	27	Casing wearing ring	38	Shaft
6	Screw	17	Leakage connection R1/2"	28	Impeller wearing ring	39	Spring pin
7	Air venting crews	18	Volute casing cover	29	Key	40	Seat ring holder
8	Screw	19	Foot	30	Key	41	Screw
9	Screw	20	Impeller	31	Sleeve	42	Washer
10	Washer	21	Greaser	32	Volute casing	43	Gasket
11	Washer	22	Gasket	33	Washer	44	Lip seal

PUMP EXPLODED VIEW

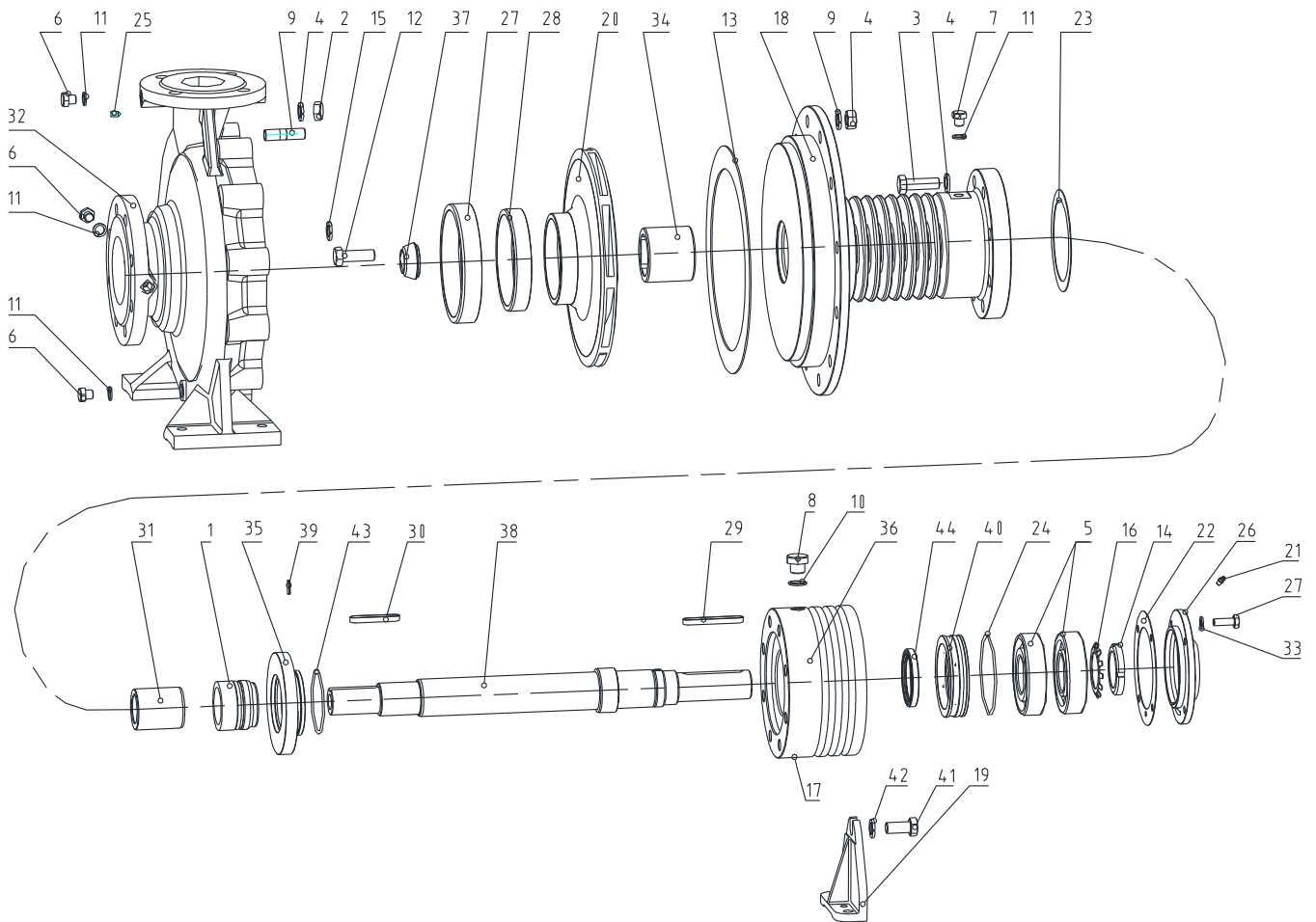

1	Mechanical seal	12	Impeller fixing screw	23	O-ring	34	Plate bearing
2	Nut	13	Gasket	24	O-ring	35	Mechanical seal cover
3	Screw	14	Lock nut	25	Screw for wearing rings fixing	36	Bearing bracket
4	Washer	15	Washer	26	Bearing cover	37	Disc
5	Ball bearings	16	Locking washer	27	Casing wearing ring	38	Shaft
6	Screw	17	Leakage connection	28	Impeller wearing ring	39	Spring pin
7	Air venting screw	18	Volute casing cover	29	Key	40	Seat ring holder
8	Screw	19	Foot	30	Key	41	Screw
9	Screw	20	Impeller	31	Sleeve	42	Washer
10	Washer	21	Greaser	32	Volute casing	43	Gasket
11	Washer	22	Gasket	33	Washer	44	Lip seal

www.volcano-pump.com