

# ULTRA A



Self-priming



Stainless steel multistage horizontal self-priming pumps. Suitable for clean water; pressurizing system; irrigation; drinking and glycol water; water treatment; heating and air conditioning; washing system.

Construction features	
<b>Pump body, mechanical seal housing</b>	stainless steel AISI 304
<b>Motor bracket</b>	aluminum
<b>Impellers, diffusers</b>	Noryl®
<b>Mechanical seal</b>	ceramic-graphite-EPDM
<b>Motor shaft</b>	stainless steel AISI 303
<b>Liquid temperature</b>	-5 ÷ +35 °C
<b>Operating pressure</b>	max 7 bar

Motor	
	3- 230/400V-50Hz
<b>2 poles induction motor</b>	1- 230V-50Hz (with thermal protection up to 1.85 kW)
<b>Insulation class</b>	F
<b>Protection degree</b>	IPX4

## U 3 A - 100/5 T

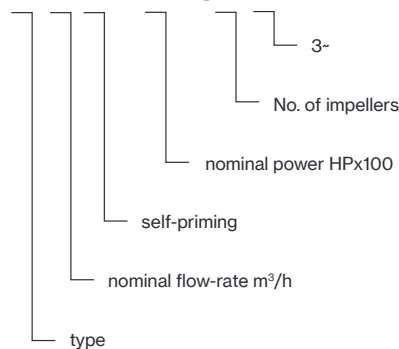

TYPE	LOTS			
	TRUCK		CONTAINER	
	PALLET (cm)	N° pumps	PALLET (cm)	N° pumps
U 3A-90/4	85×110×160	70	85×110×185	80
U 3A-100/5	80×120×150	42	80×120×175	49
U 5A-120/4	80×120×150	42	80×120×175	49
U 5A-150/5	80×120×150	42	80×120×175	49

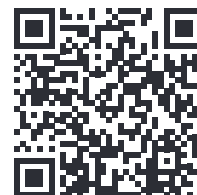

# ULTRA A

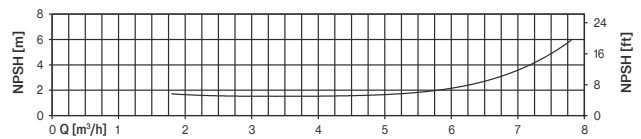
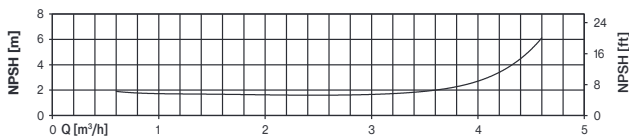
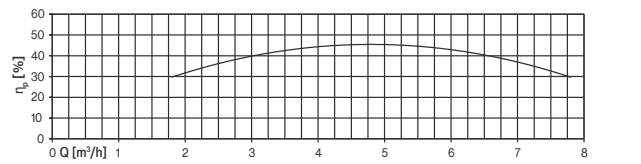
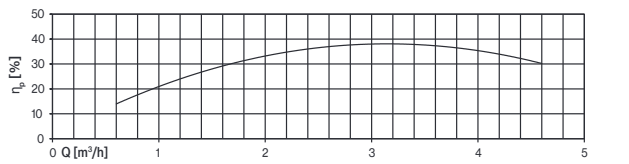
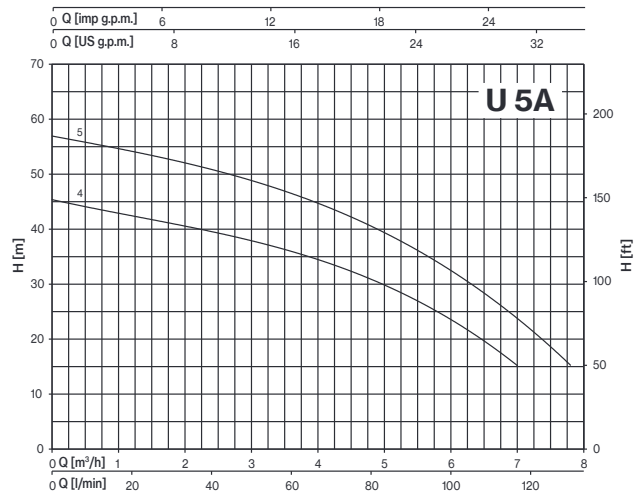
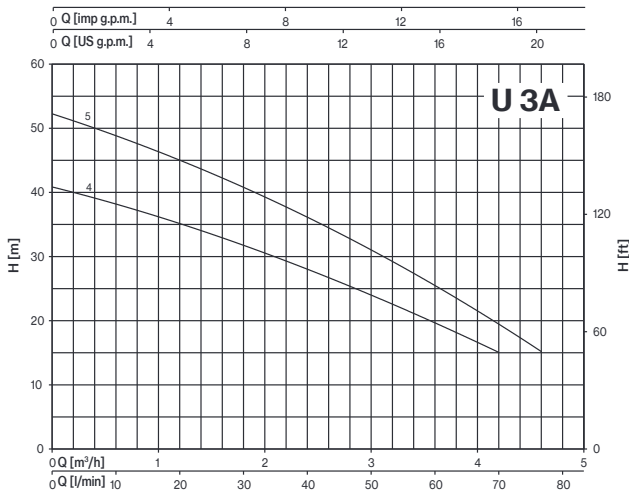

TYPE		P2		P1 (kW)		AMPERE		Q (m³/h - l/min)												
1~	3~	HP	kW	1~	3~	1~ 1x230 V 50 Hz	3~ 3x400 V 50 Hz	0	0,6	1,2	1,8	2,4	3,6	4,2	4,6	4,8	6	7	7,8	
								0	10	20	30	40	60	70	76,7	80	100	116,7	130	
								H (m)												
U 3A-90/4	U 3A-90/4 T	0,9	0,66	0,9	0,88	4	1,8	40,8	38,3	35,1	31,8	27,9	19,8	15,0						
U 3A-100/5	U 3A-100/5 T	1	0,75	1,06	1,01	4,8	1,9	52,2	48,9	45,1	40,8	36,0	25,4	19,8	15,0					
U 5A-120/4	U 5A-120/4 T	1,2	0,9	1,13	1,13	5,2	2,5	45,3			41,3	39,6	35,6	33,4	31,7	30,8	24,0	15,0		
U 5A-150/5	U 5A-150/5 T	1,5	1,1	1,47	1,39	6,8	2,8	56,8			53,0	51,0	46,1	43,2	41,2	40,1	33,0	24,0	15,0	

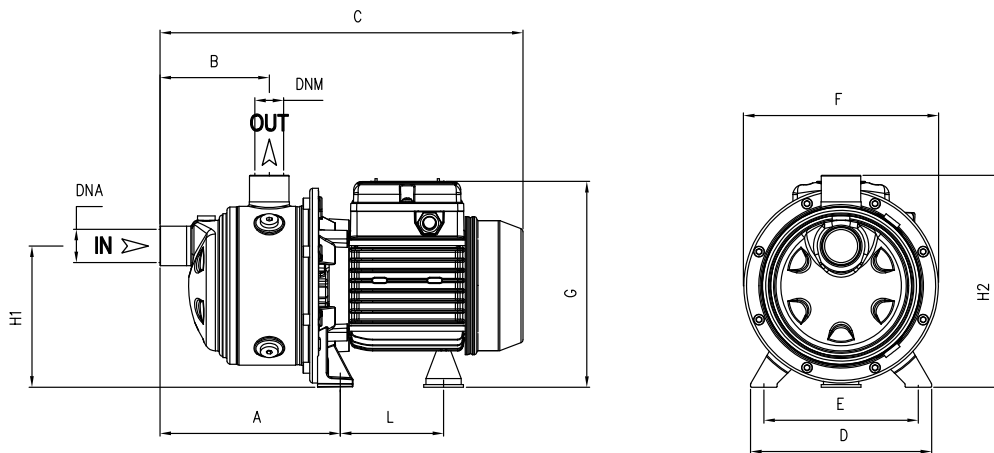

TYPE	DIMENSIONS (mm)												Kg
	A	B	C	D	E	F	G	L	H1	H2	DNA	DNM	
U 3A-90/4	190,8	175	405	164	140	178	190	93,7	128	192	1" G	1" G	9
U 3A-100/5	214,8	199	452	164	140	178	203	104,7	128	192			11,5
U 5A-120/4	190,8	175	428	164	140	178	203	104,7	128	192			11,5
U 5A-150/5	214,8	199	514	164	140	201	211	128,2	134	198			14,5

