

Standardised Chemical Pump

CPKN-SX

Sprinkler Pump

Installation/Operating Manual



Legal information/Copyright

Installation/Operating Manual CPKN-SX

Original operating manual

All rights reserved. The contents provided herein must neither be distributed, copied, reproduced, edited or processed for any other purpose, nor otherwise transmitted, published or made available to a third party without the manufacturer's express written consent.

Subject to technical modification without prior notice.

© KSB SE & Co. KGaA, Frankenthal 31/01/2018

Contents

	Glossary	5
1	General.....	6
	1.1 Principles	6
	1.2 Installation of partly completed machinery.....	6
	1.3 Target group.....	6
	1.4 Other applicable documents.....	6
	1.5 Symbols	6
2	Safety.....	8
	2.1 Key to safety symbols/markings.....	8
	2.2 General.....	8
	2.3 Intended use	8
	2.4 Personnel qualification and training.....	9
	2.5 Consequences and risks caused by non-compliance with this manual	9
	2.6 Safety awareness	9
	2.7 Safety information for the operator/user	10
	2.8 Safety information for maintenance, inspection and installation work.....	10
	2.9 Unauthorised modes of operation	10
3	Transport/Temporary Storage/Disposal.....	11
	3.1 Checking the condition upon delivery	11
	3.2 Transport.....	11
	3.3 Storage/preservation	12
	3.4 Return to supplier.....	12
	3.5 Disposal	13
4	Description of the Pump (Set).....	14
	4.1 General description	14
	4.2 Designation.....	14
	4.3 Name plate.....	14
	4.4 Design details.....	14
	4.5 Configuration and function.....	16
	4.6 Noise characteristics	17
	4.7 Scope of supply.....	17
	4.8 Dimensions and weights	17
5	Installation at Site	18
	5.1 Safety regulations.....	18
	5.2 Checks to be carried out prior to installation.....	18
	5.3 Installing the pump set	18
	5.3.1 Installation on the foundation.....	18
	5.3.2 Installation on a foundation	19
	5.3.3 Installation without foundation	20
	5.4 Piping	21
	5.4.1 Connecting the piping.....	21
	5.4.2 Permissible forces and moments at the pump nozzles.....	22
	5.4.3 Auxiliary connections.....	23
	5.5 Enclosure/insulation	23
	5.6 Checking the coupling alignment	24
	5.7 Aligning the pump and motor	24
	5.7.1 Motors with adjusting screw.....	25
	5.7.2 Motors without adjusting screw	25
	5.8 Electrical connection	26
	5.8.1 Setting the time relay	27
	5.8.2 Connecting the motor	27
	5.9 Checking the direction of rotation.....	27

6	Commissioning/Start-up/Shutdown	29
6.1	Commissioning/Start-up	29
6.1.1	Prerequisites for commissioning/start-up	29
6.1.2	Filling in lubricants	29
6.1.3	Shaft seal	30
6.1.4	Priming and venting the pump	31
6.1.5	Final check	31
6.1.6	Start-up for testing	31
6.1.7	Checking the shaft seal	31
6.1.8	Switching the pump set off after testing	32
6.2	Operating limits	32
6.2.1	Ambient temperature	32
6.2.2	Frequency of starts	32
6.2.3	Fluid handled	33
6.3	Shutdown/storage/preservation	34
6.3.1	Measures to be taken for shutdown	34
6.4	Returning to service	34
7	Servicing/Maintenance	35
7.1	Safety regulations	35
7.2	Servicing/inspection	35
7.2.1	Supervision of operation	35
7.2.2	Inspection work	36
7.2.3	Lubrication and lubricant change of rolling element bearings	37
7.3	Dismantling the pump set	38
7.3.1	General information/Safety regulations	38
7.3.2	Preparing the pump set	39
7.3.3	Removing the motor	39
7.3.4	Removing the back pull-out unit	40
7.3.5	Removing the impeller	40
7.3.6	Removing the shaft seal	40
7.3.7	Dismantling the bearings	41
7.4	Reassembling the pump set	41
7.4.1	General information/Safety regulations	41
7.4.2	Installing the bearings	42
7.4.3	Fitting the shaft seal	44
7.4.4	Fitting the impeller	45
7.4.5	Fitting the back pull-out unit	46
7.4.6	Mounting the motor	46
7.5	Tightening torques	46
7.5.1	Tightening torques	46
7.5.2	Tightening torques for the impeller nut	46
7.6	Spare parts stock	47
7.6.1	Ordering spare parts	47
7.6.2	Recommended spare parts stock for 2 years' operation to DIN 24296	47
7.6.3	Interchangeability of pump components	48
8	Trouble-shooting	49
9	Related Documents	51
9.1	General assembly drawing	51
9.1.1	General assembly drawing CPKN -SX 65-315, 80-315, 100-315	51
9.1.2	General assembly drawing CPKN-SX 125-315	53
10	EU Declaration of Conformity	55
11	Certificate of Decontamination	56
	Index	57

Glossary

Back pull-out design

The complete back pull-out unit can be pulled out without having to remove the pump casing from the piping.

Back pull-out unit

Pump without pump casing; partly completed machinery

Back pull-out unit

Pump without pump casing; partly completed machinery

Certificate of decontamination

A certificate of decontamination is enclosed by the customer when returning the product to the manufacturer to certify that the product has been properly drained to eliminate any environmental and health hazards arising from components in contact with the fluid handled.

Discharge line

The pipeline which is connected to the discharge nozzle

Hydraulic system

The part of the pump in which the kinetic energy is converted into pressure energy

Pump

Machine without drive, additional components or accessories

Pump set

Complete pump set consisting of pump, drive, additional components and accessories

Suction lift line/suction head line

The pipeline which is connected to the suction nozzle

1 General

1.1 Principles

This operating manual is supplied as an integral part of the type series and variants indicated on the front cover. The manual describes the proper and safe use of this equipment in all phases of operation.

The name plate indicates the type series and size, the main operating data, the order number and the order item number. The order number and order item number uniquely identify the pump (set) and serve as identification for all further business processes.

In the event of damage, immediately contact your nearest KSB service centre to maintain the right to claim under warranty.

Noise characteristics see (⇒ Section 4.6, Page 17)

1.2 Installation of partly completed machinery

To install partly completed machinery supplied by KSB, refer to the sub-sections under Servicing/Maintenance. (⇒ Section 7.4.5, Page 46)

1.3 Target group

This operating manual is aimed at the target group of trained and qualified specialist technical personnel. (⇒ Section 2.4, Page 9)

1.4 Other applicable documents

Table 1: Overview of other applicable documents

Document	Contents
Data sheet	Description of the technical data of the pump (set)
General arrangement drawing/ outline drawing	Description of mating and installation dimensions for the pump (set), weights
Drawing of auxiliary connections	Description of auxiliary connections
Hydraulic characteristic curve	Characteristic curves showing head, NPSH required, efficiency and power input
General assembly drawing ¹⁾	Sectional drawing of the pump
Sub-supplier product literature ¹⁾	Operating manuals and other product literature describing accessories and integrated machinery components
Spare parts lists ¹⁾	Description of spare parts
Piping layout ¹⁾	Description of auxiliary piping
Seal installation drawing ¹⁾	Drawing of the installed shaft seal
Supplementary sheet ²⁾	Instructions for installing the start-up strainer
List of components ¹⁾	Description of all pump components

For accessories and/or integrated machinery components, observe the relevant manufacturer's product literature.

1.5 Symbols

Table 2: Symbols used in this manual

Symbol	Description
✓	Conditions which need to be fulfilled before proceeding with the step-by-step instructions
▷	Safety instructions
⇒	Result of an action

1) If agreed to be included in the scope of supply

2) Depending on the design

Symbol	Description
⇒	Cross-references
1. 2.	Step-by-step instructions
	Note Recommendations and important information on how to handle the product









2 Safety

All the information contained in this section refers to hazardous situations. In addition to the present general safety information the action-related safety information given in the other sections must be observed.

2.1 Key to safety symbols/markings

Table 3: Definition of safety symbols/markings

Symbol	Description
 DANGER	DANGER This signal word indicates a high-risk hazard which, if not avoided, will result in death or serious injury.
 WARNING	WARNING This signal word indicates a medium-risk hazard which, if not avoided, could result in death or serious injury.
 CAUTION	CAUTION This signal word indicates a hazard which, if not avoided, could result in damage to the machine and its functions.
	General hazard In conjunction with one of the signal words this symbol indicates a hazard which will or could result in death or serious injury.
	Electrical hazard In conjunction with one of the signal words this symbol indicates a hazard involving electrical voltage and identifies information about protection against electrical voltage.
	Machine damage In conjunction with the signal word CAUTION this symbol indicates a hazard for the machine and its functions.

2.2 General

This operating manual contains general installation, operating and maintenance instructions that must be observed to ensure safe operation of the system and prevent personal injury and damage to property.

The safety information in all sections of this manual must be complied with.

The operating manual must be read and understood by the responsible specialist personnel/operators prior to installation and commissioning.

The contents of this operating manual must be available to the specialist personnel at the site at all times.

Information attached directly to the product must always be complied with and kept in a perfectly legible condition at all times. This applies to, for example:

- Arrow indicating the direction of rotation
- Markings for connections
- Name plate

The operator is responsible for ensuring compliance with all local regulations not taken into account in this operating manual.

2.3 Intended use

The pump (set) must only be operated within the operating limits described in the other applicable documents.

- Only operate pumps/pump sets which are in perfect technical condition.
- Do not operate the pump (set) in partially assembled condition.
- Only use the pump to handle the fluids described in the data sheet or product literature of the pump model.
- Never operate the pump without the fluid handled.

- Observe the minimum flow rates indicated in the data sheet or product literature (to prevent overheating, bearing damage, etc).
- Observe the maximum flow rates indicated in the data sheet or product literature (to prevent overheating, mechanical seal damage, cavitation damage, bearing damage, etc).
- Do not throttle the flow rate on the suction side of the pump (to prevent cavitation damage).
- Consult the manufacturer about any use or mode of operation not described in the data sheet or product literature.

Prevention of foreseeable misuse

- Never open discharge-side shut-off elements further than permitted.
 - The maximum flow rate specified in the data sheet or product literature would be exceeded.
 - Risk of cavitation damage
- Never exceed the permissible operating limits specified in the data sheet or product literature regarding pressure, temperature, etc.
- Observe all safety information and instructions in this manual.

2.4 Personnel qualification and training

All personnel involved must be fully qualified to transport, install, operate, maintain and inspect the machinery this manual refers to.

The responsibilities, competence and supervision of all personnel involved in transport, installation, operation, maintenance and inspection must be clearly defined by the operator.

Deficits in knowledge must be rectified by means of training and instruction provided by sufficiently trained specialist personnel. If required, the operator can commission the manufacturer/supplier to train the personnel.

Training on the pump (set) must always be supervised by technical specialist personnel.

2.5 Consequences and risks caused by non-compliance with this manual

- Non-compliance with this operating manual will lead to forfeiture of warranty cover and of any and all rights to claims for damages.
- Non-compliance can, for example, have the following consequences:
 - Hazards to persons due to electrical, thermal, mechanical and chemical effects and explosions
 - Failure of important product functions
 - Failure of prescribed maintenance and servicing practices
 - Hazard to the environment due to leakage of hazardous substances

2.6 Safety awareness

In addition to the safety information contained in this manual and the intended use, the following safety regulations shall be complied with:

- Accident prevention, health and safety regulations
- Explosion protection regulations
- Safety regulations for handling hazardous substances
- Applicable standards and laws

2.7 Safety information for the operator/user

- Fit protective equipment (e.g. contact guards) supplied by the operator for hot, cold or moving parts, and check that the equipment functions properly.
- Do not remove any protective equipment (e.g. contact guards) during operation.
- Provide the personnel with protective equipment and make sure it is used.
- Contain leakages (e.g. at the shaft seal) of hazardous fluids handled (e.g. explosive, toxic, hot) so as to avoid any danger to persons and the environment. Adhere to all relevant laws.
- Eliminate all electrical hazards. (In this respect refer to the applicable national safety regulations and/or regulations issued by the local energy supply companies.)
- If shutting down the pump does not increase potential risk, fit an emergency-stop control device in the immediate vicinity of the pump (set) during pump set installation.

2.8 Safety information for maintenance, inspection and installation work

- Modifications or alterations of the pump are only permitted with the manufacturer's prior consent.
- Use only original spare parts or parts authorised by the manufacturer. The use of other parts can invalidate any liability of the manufacturer for resulting damage.
- The operator ensures that all maintenance, inspection and installation work is performed by authorised, qualified specialist personnel who are thoroughly familiar with the manual.
- Only carry out work on the pump (set) during standstill of the pump.
- The pump casing must have cooled down to ambient temperature.
- Pump pressure must have been released and the pump must have been drained.
- When taking the pump set out of service always adhere to the procedure described in the manual. (⇒ Section 6.3, Page 34)
- Decontaminate pumps which handle fluids posing a health hazard.
- As soon as the work has been completed, re-install and/or re-activate any safety-relevant and protective devices. Before returning the product to service, observe all instructions on commissioning. (⇒ Section 6.1, Page 29)

2.9 Unauthorised modes of operation

Never operate the pump (set) outside the limits stated in the data sheet and in this manual.

The warranty relating to the operating reliability and safety of the supplied pump (set) is only valid if the equipment is used in accordance with its intended use. (⇒ Section 2.3, Page 8)

3 Transport/Temporary Storage/Disposal

3.1 Checking the condition upon delivery

1. On transfer of goods, check each packaging unit for damage.
2. In the event of in-transit damage, assess the exact damage, document it and notify KSB or the supplying dealer and the insurer about the damage in writing immediately.

3.2 Transport

	DANGER
	<p>The pump (set) could slip out of the suspension arrangement Danger to life from falling parts!</p> <ul style="list-style-type: none"> ▷ Always transport the pump (set) in the specified position. ▷ Never attach the suspension arrangement to the free shaft end or the motor eyebolt. ▷ Observe the information on weights, centre of gravity and fastening points. ▷ Observe the applicable local accident prevention regulations. ▷ Use suitable, permitted lifting accessories, e.g. self-tightening lifting tongs.

To transport the pump/pump set or back pull-out unit suspend it from the lifting tackle as shown.

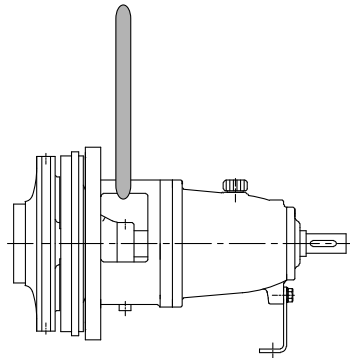

Fig. 1: Transporting the back pull-out unit

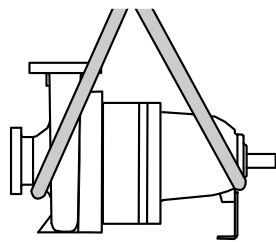

Fig. 2: Transporting the pump

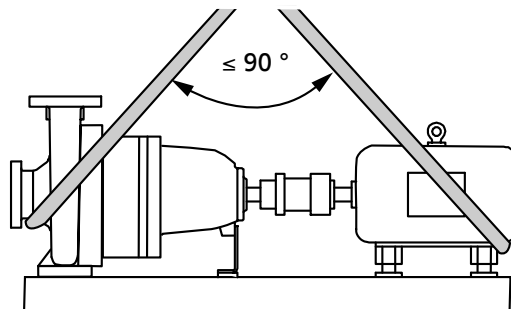

Fig. 3: Transporting the pump set

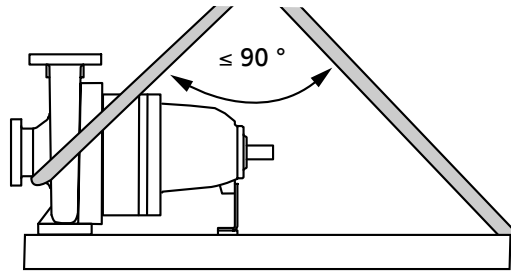

Fig. 4: Transporting the pump on the baseplate

3.3 Storage/preservation

If commissioning is to take place some time after delivery, we recommend that the following measures be taken for pump (set) storage.

	<p style="background-color: #FFD700; padding: 5px;">CAUTION</p> <p>Damage during storage due to humidity, dirt, or vermin Corrosion/contamination of the pump (set)!</p> <ul style="list-style-type: none"> ▷ For outdoor storage cover the packed or unpacked pump (set) and accessories with waterproof material.
	<p style="background-color: #FFD700; padding: 5px;">CAUTION</p> <p>Wet, contaminated or damaged openings and connections Leakage or damage to the pump set!</p> <ul style="list-style-type: none"> ▷ Only remove caps/covers from the openings of the pump set at the time of installation.

Store the pump (set) in a dry, protected room where the atmospheric humidity is as constant as possible.

Rotate the shaft by hand once a month, e.g. via the motor fan.

If properly stored indoors, the pump set is protected for a maximum of 12 months. New pumps/pump sets are supplied by our factory duly prepared for storage.



For storing a pump (set) which has already been operated, observe the instructions in (⇒ Section 6.3.1, Page 34) .

3.4 Return to supplier

1. Drain the pump as per operating instructions.
2. Flush and clean the pump, particularly if it has been used for handling noxious, explosive, hot or other hazardous fluids.
3. If the pump has handled fluids whose residues could lead to corrosion damage in the presence of atmospheric humidity or could ignite upon contact with oxygen also neutralise the pump and blow through with anhydrous inert gas to ensure drying.
4. Always complete and enclose a certificate of decontamination when returning the pump.
Indicate any safety measures and decontamination measures taken.
(⇒ Section 11, Page 56)

	<p style="background-color: #0070C0; color: white; padding: 5px;">NOTE</p> <p>If required, a blank certificate of decontamination can be downloaded from the following web site: www.ksb.com/certificate_of_decontamination</p>
--	--

3.5 Disposal

	 WARNING
	<p>Fluids handled, consumables and supplies which are hot and/or pose a health hazard</p> <p>Hazard to persons and the environment!</p> <ul style="list-style-type: none">▷ Collect and properly dispose of flushing fluid and any fluid residues.▷ Wear safety clothing and a protective mask if required.▷ Observe all legal regulations on the disposal of fluids posing a health hazard.

1. Dismantle the pump (set).
Collect greases and other lubricants during dismantling.
2. Separate and sort the pump materials, e.g. by:
 - Metals
 - Plastics
 - Electronic waste
 - Greases and other lubricants
3. Dispose of materials in accordance with local regulations or in another controlled manner.

4 Description of the Pump (Set)

4.1 General description

- Volute casing pump for sprinkler installations to VdS CEA 4001

4.2 Designation

Example: CPKN- S X 80-315

Table 4: Key to the designation

Code	Description
CPKN	Type series
S	Casing made of nodular cast iron
X	Sprinkler version
80	Nominal discharge nozzle diameter [mm]
315	Nominal impeller diameter [mm]

4.3 Name plate

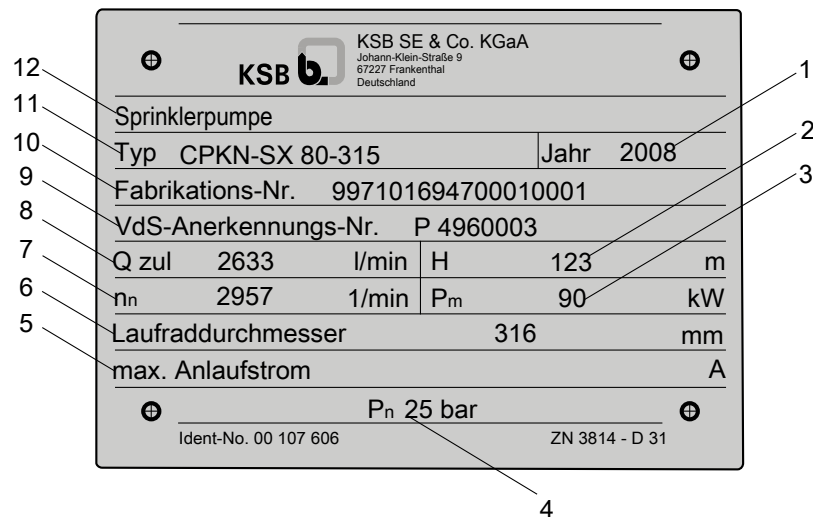

Fig. 5: Name plate (example)

1	Year of construction	2	VdS approved head
3	Required motor rating at 15 m NPSH	4	Nominal pressure
5	Maximum starting current (for submersible pump sets only)	6	Impeller diameter [mm]
7	Rated speed	8	VdS approved flow rate
9	VdS approval number	10	KSB order and order item number
11	Type series, size	12	Application

4.4 Design details

Design

- Volute casing pump
- Horizontal installation
- Back pull-out design
- Single-stage

Pump casing

- Single or double volute, depending on the pump size
- Radially split volute casing
- Volute casing with integrally cast pump feet
- Volute casing with casing wear ring and casing cover

Impeller type

- Closed radial impeller with multiply curved vanes
- Back vanes reduce axial thrust.

Shaft seal

- Gland packing
- Standardised mechanical seals to EN 12756, K design

Table 5: Seal chamber with different shaft seals (examples)

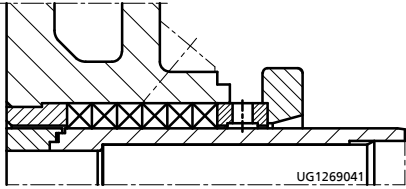
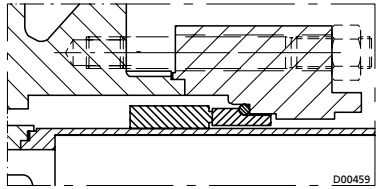
Type of seal	Drawing
Gland packing	
Cylindrical seal chamber Standardised mechanical seal	

Bearings

Design specifications Motor-end bearing:

- Fixed bearing
- Paired angular contact ball bearings
- Axial movement of the rotor limited to 0.5 mm maximum
- Oil lubrication

Pump-end bearing:

- Radial bearing
- Cylindrical roller bearing
- Absorbs radial loads only
- Oil lubrication

Bearing bracket designation Example: UP04

Table 6: Bearing bracket designation

Designation	Description
UP	Bearing bracket
04	Size code (based on the dimensions of seal chamber and shaft end)

Refer to the data sheet to find your bearing design.

Bearings used Table 7: Bearing design

KSB designation	FAG designation	SKF designation
B.G.8	B-TVP-UA 80	BEC86P

Table 8: Standard bearing assembly

Bearing bracket	Rolling element bearings	
	Pump end	Motor end
UP04	NU311	2 x 7311B.G.8
125-315	NU313	2 x 7313B.G.8

4.5 Configuration and function

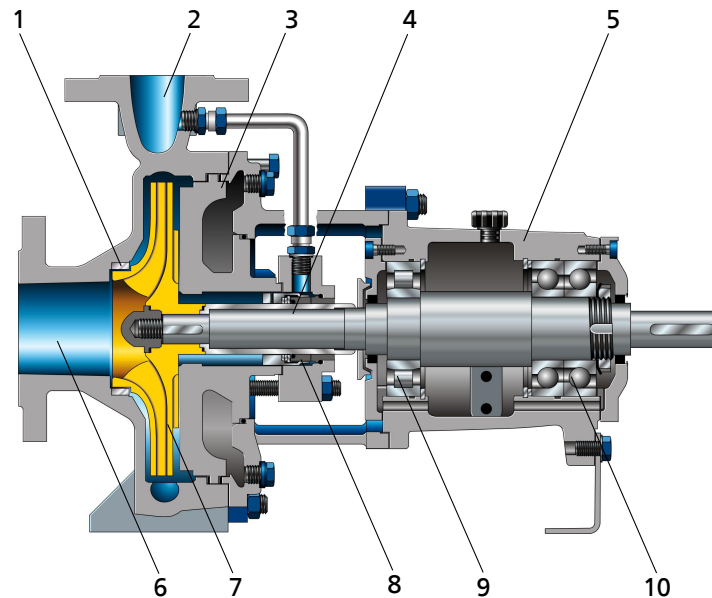
Fig. 6: Sectional drawing

1	Clearance gap	2	Discharge nozzle
3	Casing cover	4	Drive shaft
5	Bearing bracket	6	Suction nozzle
7	Impeller	8	Shaft seal
9	Rolling element bearing, pump end	10	Rolling element bearing, motor end

Design The pump is designed with an axial fluid inlet and a radial or tangential outlet. The hydraulic system runs in its own bearings and is connected to the motor by a shaft coupling.

Function The fluid enters the pump axially via the suction nozzle (6) and is accelerated outward by the rotating impeller (7). In the flow passage of the pump casing the kinetic energy of the fluid is converted into pressure energy. The fluid is pumped to the discharge nozzle (2), where it leaves the pump. The clearance gap (1) prevents any fluid from flowing back from the casing to the suction nozzle. At the rear side of the impeller, the shaft (4) enters the casing via the casing cover (3). The shaft passage through the cover is sealed to atmosphere with a shaft seal (8). The shaft runs in rolling element bearings (9 and 10), which are supported by a bearing bracket (5) linked with the pump casing and/or casing cover.

Sealing The pump is sealed by a shaft seal (standardised mechanical seal or gland packing).

4.6 Noise characteristics

Table 9: Surface sound pressure level L_{pA} ^{3) 4)}

Rated power input P_N [kW]	Pump	Pump set
	2900 rpm [dB]	2900 rpm [dB]
55	73	80
75	75	81
90	76	82
110	77	82
132	78	83
160	79	84
200	80	84
250	81	85

4.7 Scope of supply

Depending on the model, the following items are included in the scope of supply:

- Pump

Drive

- Surface-cooled IEC frame three-phase squirrel-cage motor

Coupling

- Flexible coupling with or without spacer

Contact guard

- Coupling guard

Baseplate

- Channel section steel or folded steel plate

Special accessories

- As required

4.8 Dimensions and weights

For dimensions and weights please refer to the general arrangement drawing/outline drawing of the pump/pump set.

3) Spatial average; as per ISO 3744 and EN 12639; valid for operating range $Q/Q_{opt} = 0.8 - 1.1$ and non-cavitating pump operation. If noise levels are to be warranted: Add an allowance of +3dB for measuring and manufacturing tolerances
 4) Increase for 60 Hz operation: 3500 rpm+3dB; 1750 rpm +1dB

5 Installation at Site

5.1 Safety regulations

For positioning, installing and operating sprinkler pumps, always observe the following fire protection standards and directives:

- VDS CEA 4001
- CEA 4001
- EN 12845
- NFPA 20
- FM GLOBAL

5.2 Checks to be carried out prior to installation

Place of installation

	WARNING
	<p>Installation on mounting surface which is unsecured and cannot support the load Personal injury and damage to property!</p> <ul style="list-style-type: none"> ▷ Use a concrete of compressive strength class C12/15 which meets the requirements of exposure class XC1 to EN 206-1. ▷ The mounting surface must be set, flat, and level. ▷ Observe the weights indicated.

1. Check the structural requirements.
All structural work required must have been prepared in accordance with the dimensions stated in the outline drawing/general arrangement drawing.

5.3 Installing the pump set

Always install the pump set in a horizontal position.

5.3.1 Installation on the foundation

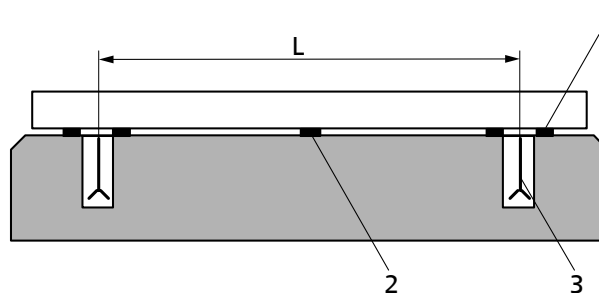

Fig. 7: Fitting the shims

L	Bolt-to-bolt distance	1	Shim
2	Shim if (L) > 800 mm	3	Foundation bolt

- ✓ The foundation has the required strength and characteristics.
 - ✓ The foundation has been prepared in accordance with the dimensions given in the outline drawing/general arrangement drawing.
1. Position the pump set on the foundation and level it with the help of a spirit level placed on the shaft and discharge nozzle.
Permissible deviation: 0.2 mm/m
 2. Use shims (1) for height compensation, if necessary.
Always fit shims, if any, immediately to the left and right of the foundation bolts (3) between the baseplate/foundation frame and the foundation.

For a bolt-to-bolt distance (L) > 800 mm fit additional shims (2) halfway between the bolt holes.

All shims must lie perfectly flush.

3. Insert the foundation bolts (3) into the holes provided.
4. Use concrete to set the foundation bolts (3) into the foundation.
5. Wait until the concrete has set firmly, then level the baseplate.
6. Tighten the foundation bolts (3) evenly and firmly.

	NOTE
	For baseplates more than 400 mm wide grouting the baseplate with low-shrinkage concrete is recommended.

	NOTE
	For baseplates made of grey cast iron grouting the baseplate with low-shrinkage concrete is recommended.

	NOTE
	For low-noise operation contact the manufacturer to check whether the pump set can be installed on anti-vibration mounts.

5.3.2 Installation on a foundation

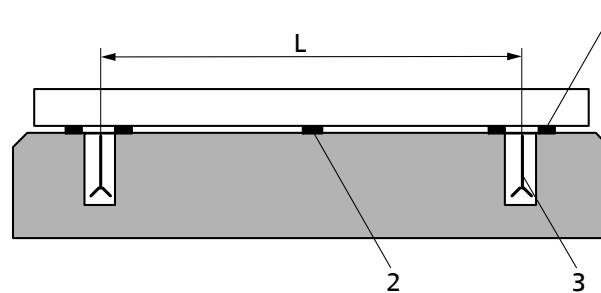

Fig. 8: Fitting the shims

L	Bolt-to-bolt distance	1	Shim
2	Shim for bolt-to-bolt distance > 800 mm	3	Foundation bolt

- ✓ The foundation has the required strength and characteristics.
 - ✓ The foundation has been prepared in accordance with the dimensions given in the outline drawing/general arrangement drawing.
1. Position the pump set on the foundation and level it with the help of a spirit level placed on the shaft and discharge nozzle.
Permissible deviation: 0.2 mm/m
 2. Use shims (1) for height compensation if necessary.
Always fit shims, if any, immediately to the left and right of the foundation bolts (3) between the baseplate/foundation frame and the foundation.
For a bolt-to-bolt distance (L) > 800 mm fit additional shims (2) halfway between the bolt holes.
All shims must lie perfectly flush.
 3. Insert the foundation bolts (3) into the holes provided.
 4. Use concrete to set the foundation bolts (3) into the foundation.
 5. Wait until the concrete has set firmly, then level the baseplate.

6. Tighten the foundation bolts (3) evenly and firmly.
7. Grout the baseplate using low-shrinkage concrete with a standard particle size and a water/cement ratio of ≤ 0.5 .
Produce flowability with the help of a solvent.
Perform secondary treatment of the concrete to DIN 1045.

	NOTE
	For low-noise operation contact the manufacturer to check whether the pump set can be installed on anti-vibration mounts.
	NOTE
	Expansion joints can be fitted between the pump and the suction/discharge line.

5.3.3 Installation without foundation

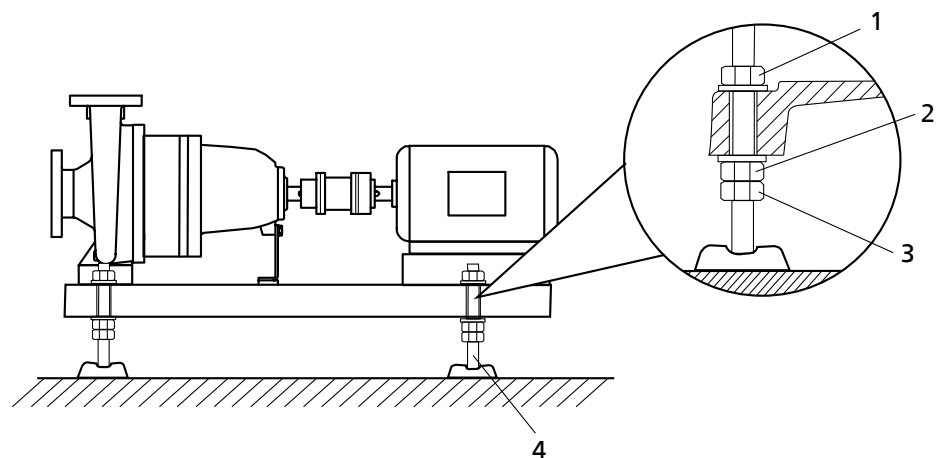





Fig. 9: Adjusting the adjusting elements

1, 3	Locknut	2	Adjusting nut
4	Adjusting element		

- ✓ The installation surface has the required strength and characteristics.
 1. Position the pump set on the machine mounts (4) and align it with the help of a spirit level (on the shaft/discharge nozzle).
 2. To adjust any differences in height, loosen the bolts and locknuts (1, 3) of the machine mounts (4).
 3. Turn the adjusting nut (2) until any differences in height have been compensated.
 4. Re-tighten the locknuts (1, 3) at the machine mounts (4).

5.4 Piping

5.4.1 Connecting the piping

	<p>⚠ DANGER</p> <p>Impermissible loads acting on the pump nozzles Danger to life from escaping hot, toxic, corrosive or flammable fluids!</p> <ul style="list-style-type: none"> ▷ Do not use the pump as an anchorage point for the piping. ▷ Anchor the pipes in close proximity to the pump and connect them properly without transmitting any stresses or strains. ▷ Observe the permissible forces and moments at the pump nozzles. ▷ Take appropriate measures to compensate for thermal expansion of the piping.
	<p>CAUTION</p> <p>Incorrect earthing during welding work at the piping Destruction of rolling element bearings (pitting effect)!</p> <ul style="list-style-type: none"> ▷ Never earth the electric welding equipment on the pump or baseplate. ▷ Prevent current flowing through the rolling element bearings.
	<p>NOTE</p> <p>Installing check and shut-off elements in the system is recommended, depending on the type of plant and pump. However, such elements must not obstruct proper drainage or hinder disassembly of the pump.</p>
	<p>NOTE</p> <p>VdS-certified pumps must be connected in compliance with the current VdS CEA 4001 regulations.</p>

- ✓ Suction lift lines have been laid with a rising slope, suction head lines with a downward slope towards the pump.
- ✓ A flow stabilisation section having a length equivalent to at least twice the diameter of the suction flange has been provided upstream of the suction flange.
- ✓ The nominal diameters of the pipelines are equal to or greater than the nominal diameters of the pump nozzles.
 The nominal diameter of the suction line shall be in compliance with VdS form 3003. The installation of check and shut-off valves is also defined by VdS form 3003.
- ✓ To prevent excessive pressure losses, adapters to larger diameters must be in accordance with the fire protection directives.
- ✓ The pipelines have been anchored in close proximity to the pump and connected without transmitting any stresses or strains.
 1. Thoroughly clean, flush and blow through all vessels, pipelines and connections (especially of new installations).
 2. Before installing the pump in the piping, remove the flange covers on the suction and discharge nozzles of the pump.

	CAUTION
	<p>Welding beads, scale and other impurities in the piping Damage to the pump!</p> <ul style="list-style-type: none"> ▷ Remove any impurities from the piping. ▷ If necessary, install a filter. ▷ Observe the information in (⇒ Section 7.2.2.2, Page 37) .

3. Check that the inside of the pump is free from any foreign objects. Remove any foreign objects.
4. If required, install a filter in the piping (see drawing: Filter in the piping). Observe the regulations laid down in the fire protection directives!

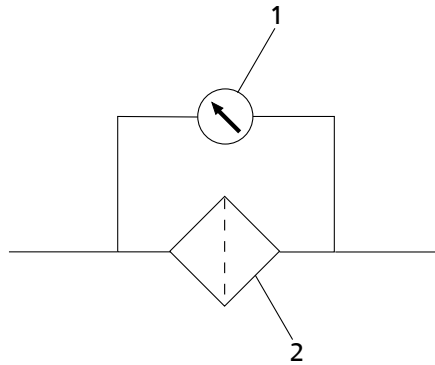
Fig. 10: Filter in the piping

1	Differential pressure gauge	2	Filter
---	-----------------------------	---	--------

	NOTE
	<p>Use a filter with laid-in wire mesh (mesh width 0.5 mm, wire diameter 0.25 mm) of corrosion-resistant material. Use a filter with a filter area three times the cross-section of the piping. Conical filters have proved suitable.</p>

5. Connect the pump nozzles to the piping.

	CAUTION
	<p>Aggressive flushing liquid and pickling agent Damage to the pump!</p> <ul style="list-style-type: none"> ▷ Match the cleaning operation mode and duration of flushing and pickling to the casing materials and seal materials used.

5.4.2 Permissible forces and moments at the pump nozzles

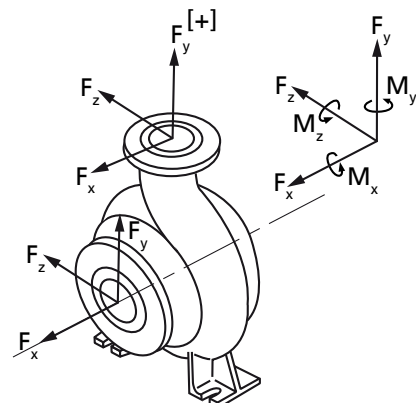

The resulting permissible forces have been determined according to the following formulas:

$$F_{\text{res D}} \leq \sqrt{F_x^2 + F_z^2}$$

$$F_{\text{res S}} \leq \sqrt{F_y^2 + F_z^2}$$

Forces and moments at the pump nozzles

The data on forces and moments apply to static piping loads only. If the limits are exceeded, the values must be checked and verified.

If computerised strength analysis is required, please contact KSB.

The values are only applicable if the pump is installed on a baseplate and bolted to a rigid and level foundation.

Table 10: Forces and moments at the pump nozzles

Pump sizes	Suction nozzle [N]				Discharge nozzle [N]					Suction nozzle [Nm]			Discharge nozzle [Nm]		
	F _x	F _y	F _z	F _{res}	F _x	F _{yTens+}	F _{yPress-}	F _z	F _{res}	M _x	M _y	M _z	M _x	M _y	M _z
65-315	2700	1750	2150	2750	1400	900	1750	1150	1800	2000	1500	1000	1150	850	600
80-315	3700	2400	2950	3800	1700	1100	2150	1400	2200	2750	2100	1400	1450	1100	750
100-315	3700	2400	2950	3800	2150	1350	2700	1750	2800	2750	2100	1400	2000	1500	1000
125-315	7350	4700	5700	7400	2950	1850	3700	2400	3800	5300	3850	2650	2750	2100	1400

5.4.3 Auxiliary connections

	<p>⚠ DANGER</p>
	<p>Risk of potentially explosive atmosphere by mixing of incompatible fluids in the auxiliary piping</p> <p>Risk of burns!</p> <p>Explosion hazard!</p> <ul style="list-style-type: none"> ▷ Make sure that the barrier fluid or quench liquid are compatible with the fluid handled.
	<p>⚠ WARNING</p>
	<p>Failure to use or incorrect use of auxiliary connections (e.g. barrier fluid, flushing liquid, etc.)</p> <p>Risk of injury from escaping fluid!</p> <p>Risk of burns!</p> <p>Malfunction of the pump!</p> <ul style="list-style-type: none"> ▷ Refer to the general arrangement drawing, the piping layout and pump markings (if any) for the quantity, dimensions and locations of auxiliary connections. ▷ Use the auxiliary connections provided.

5.5 Enclosure/insulation

	<p>CAUTION</p>
	<p>Heat build-up in the bearing bracket</p> <p>Damage to the bearing!</p> <ul style="list-style-type: none"> ▷ Never insulate the bearing bracket, bearing bracket lantern and casing cover.

5.6 Checking the coupling alignment

	CAUTION
	<p>Misalignment of pump and motor shafts Damage to pump, motor and coupling!</p> <ul style="list-style-type: none"> ▷ Always check the coupling after the pump has been installed and connected to the piping. ▷ Also check the coupling of pump sets supplied with pump and motor mounted on the same baseplate.

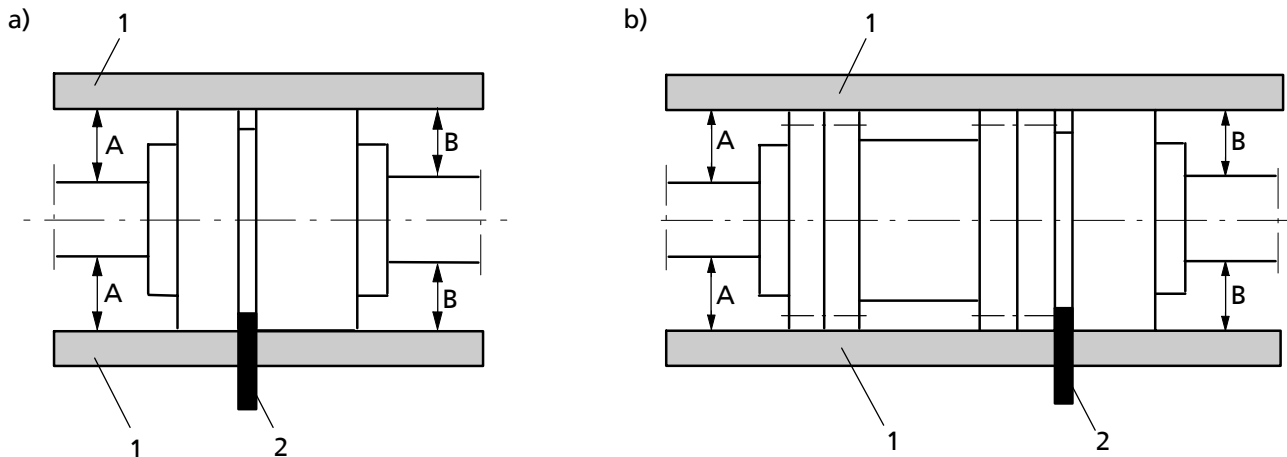

Fig. 11: Checking the coupling alignment: Coupling without spacer sleeve (a) or Coupling with spacer sleeve (b)

1	Straight-edge	2	Gauge
---	---------------	---	-------

- ✓ The coupling guard and its footboard, if any, have been removed.
 1. Loosen the support foot and re-tighten it without transmitting any stresses and strains.
 2. Place the straight-edge axially on both coupling halves.
 3. Leave the straight-edge in this position and turn the coupling by hand.
 The coupling is aligned correctly if the distances A and B to the respective shafts are the same at all points around the circumference.
 The radial and axial deviation between the two coupling halves must not exceed 0.1 mm, during standstill as well as at operating temperature and under inlet pressure.
 4. Check the distance (dimension see general arrangement drawing) between the two coupling halves around the circumference.
 The coupling is correctly aligned if the distance between the two coupling halves is the same at all points around the circumference.
 The radial and axial deviation between the two coupling halves must not exceed 0.1 mm, during standstill as well as at operating temperature and under inlet pressure.
 5. If alignment is correct, re-install the coupling guard and its footboard, if any.

5.7 Aligning the pump and motor

After having installed the pump set and connected the piping, check the coupling alignment and, if required, re-align the pump set (at the motor).

5.7.1 Motors with adjusting screw

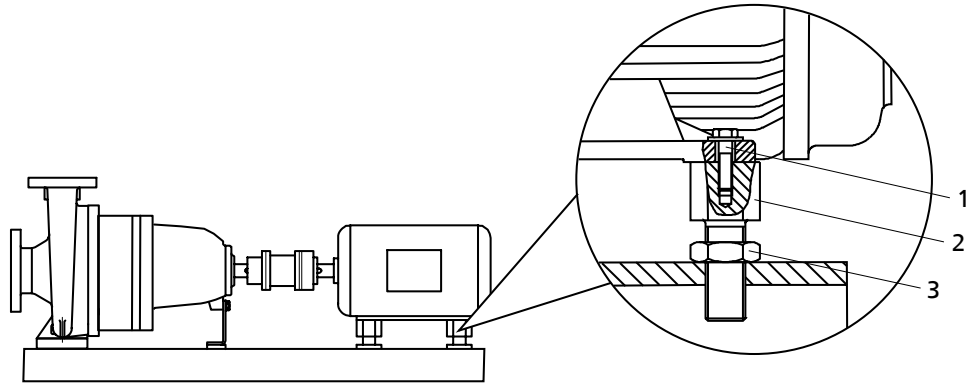

Fig. 12: Motor with adjusting screw

1	Hexagon head bolt	2	Adjusting screw
3	Lock nut		

✓ The coupling guard and the footboard for the coupling guard, if any, have been removed.

1. Check the coupling alignment.
2. Unscrew the hexagon head bolts (1) at the motor and the locknuts (3) at the baseplate.
3. Turn the adjusting screws (2) by hand or by means of an open-end wrench until the coupling alignment is correct and all motor feet rest squarely on the baseplate.
4. Re-tighten the hexagon head bolts (1) at the motor and the locknuts (3) at the baseplate.
5. Check that the coupling and shaft can easily be rotated by hand.

	<p>⚠ WARNING</p>
	<p>Unprotected rotating coupling Risk of injury by rotating shafts!</p> <ul style="list-style-type: none"> ▷ Always operate the pump set with a coupling guard. If the customer specifically requests not to include a coupling guard in KSB's delivery, then the operator must supply one! ▷ Observe all relevant regulations for selecting a coupling guard.

6. Re-install the coupling guard and the footboard for the coupling guard, if any.
7. Check the distance between coupling and coupling guard.
The coupling and coupling guard must not come into contact.

5.7.2 Motors without adjusting screw

Any differences in shaft centre height between the pump and the motor are compensated by means of shims.

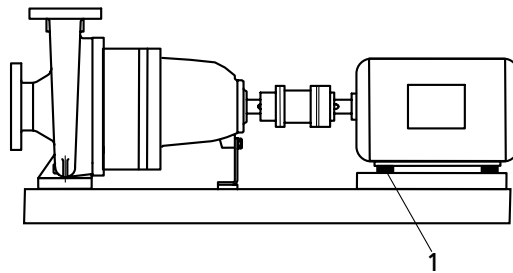



Fig. 13: Pump set with shim

1	Shim
---	------

- ✓ The coupling guard and its footboard, if any, have been removed.
 1. Check the coupling alignment.
 2. Loosen the hexagon head bolts at the motor.
 3. Insert shims underneath the motor feet until the difference in shaft centreline height has been compensated.
 4. Re-tighten the hexagon head bolts.
 5. Check proper functioning of coupling/shaft.
Check that coupling/shaft can easily be rotated by hand.

	<p>! WARNING</p>
	<p>Unprotected rotating coupling Risk of injury by rotating shafts!</p> <ul style="list-style-type: none"> ▷ Always operate the pump set with a coupling guard. If the customer specifically requests not to include a coupling guard in KSB's delivery, then the operator must supply one! ▷ Observe all relevant regulations for selecting a coupling guard.

6. Fit the coupling guard and its footboard, if any.
7. Check the distance between coupling and coupling guard.
The coupling guard must not touch the coupling.

5.8 Electrical connection

	<p>! DANGER</p>
	<p>Electrical connection work by unqualified personnel Risk of fatal injury due to electric shock!</p> <ul style="list-style-type: none"> ▷ Always have the electrical connections installed by a trained and qualified electrician. ▷ Observe regulations IEC 60364 and, for explosion-proof models, EN 60079.

	<p>! WARNING</p>
	<p>Incorrect connection to the mains Damage to the mains network, short circuit!</p> <ul style="list-style-type: none"> ▷ Observe the technical specifications of the local energy supply companies.

	<p>NOTE</p>
	<p>It is recommended to fit a motor protection device. However, this device must not trip the pump set; it must serve as an indicator only.</p>

	NOTE
	<p>In compliance with IEC 60034-8, three-phase motors are always wired for clockwise rotation (looking at the motor shaft stub). The pump's direction of rotation is indicated by an arrow on the pump.</p>

1. Check the available mains voltage against the data on the name plate.
2. Select an appropriate start-up method.
3. Match the motor's direction of rotation to that of the pump.
4. Observe the manufacturer's product literature supplied with the motor.

5.8.1 Setting the time relay

	CAUTION
	<p>Switchover between star and delta on three-phase motors with star-delta starting takes too long. Damage to the pump (set)!</p> <p>▸ Keep switch-over intervals between star and delta as short as possible.</p>

Table 11: Time relay settings for star-delta starting:

Motor rating [kW]	Y time to be set [s]
≤ 30	< 3
> 30	< 5

5.8.2 Connecting the motor



	NOTE
	<p>Make sure that the pump set starts up automatically in the event of fire and that it can only be switched off manually. Any PTC thermistors connected must not lead to the pump set switching off.</p>

	NOTE
	<p>In compliance with IEC 60034-8, three-phase motors are always wired for clockwise rotation (looking at the motor shaft stub). The pump's direction of rotation is indicated by an arrow on the pump.</p>

1. Match the motor's direction of rotation to that of the pump.
2. Observe the manufacturer's product literature supplied with the motor.

5.9 Checking the direction of rotation

	WARNING
	<p>Hands inside the pump casing Risk of injuries, damage to the pump!</p> <p>▸ Always disconnect the pump set from the power supply and secure it against unintentional start-up before inserting your hands or other objects into the pump.</p>

	CAUTION
	<p>Incorrect direction of rotation with non-reversible mechanical seal Damage to the mechanical seal and leakage!</p> <ul style="list-style-type: none"> ▸ Separate the pump from the motor to check the direction of rotation.
	CAUTION
	<p>Drive and pump running in the wrong direction of rotation Damage to the pump!</p> <ul style="list-style-type: none"> ▸ Refer to the arrow indicating the direction of rotation on the pump. ▸ Check the direction of rotation. If required, check the electrical connection and correct the direction of rotation.

The correct direction of rotation of motor and pump is clockwise (seen from the motor end).

1. Start the pump set and stop it again immediately to determine the motor's direction of rotation.
2. Check the direction of rotation.
 The motor's direction of rotation must match the arrow indicating the direction of rotation on the pump.
3. If the motor runs in the wrong direction of rotation, check the electrical connection of the motor and the control system, if necessary.

6 Commissioning/Start-up/Shutdown

6.1 Commissioning/Start-up

6.1.1 Prerequisites for commissioning/start-up

Before commissioning/starting up the pump set, make sure that the following conditions are met:

- The pump set has been properly connected to the electric power supply and is equipped with all protection devices.
- The pump has been primed with the fluid to be handled.
- The direction of rotation has been checked. (⇒ Section 5.9, Page 27)
- All auxiliary connections required are connected and operational.
- The lubricants have been checked.
- After prolonged shutdown of the pump (set), the activities described in (⇒ Section 6.4, Page 34) have been carried out.

6.1.2 Filling in lubricants

Fill the bearing bracket with lubricating oil.



Oil quality see (⇒ Section 7.2.3.1.2, Page 37)

Oil quantity see (⇒ Section 7.2.3.1.3, Page 38)

Filling the constant level oiler with lubricating oil

Filling the constant level oiler with lubricating oil (oil-lubricated bearings only)

- ✓ The constant level oiler is screwed into the upper tapping hole of the bearing bracket.

	<p>NOTE</p> <p>If no constant level oiler is provided on the bearing bracket, the oil level can be read in the middle of the oil level gauge arranged at the side of the bearing bracket.</p>
	<p>CAUTION</p> <p>Insufficient quantity of lubricating oil in the reservoir of the constant level oiler Damage to the bearings!</p> <ul style="list-style-type: none"> ▷ Regularly check the oil level. ▷ Always fill the oil reservoir completely. ▷ Keep the oil reservoir properly filled at all times.

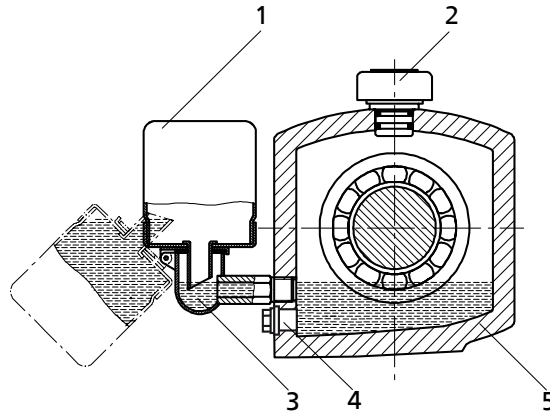
Fig. 14: Bearing bracket with constant level oiler

1	Constant level oiler	2	Vent plug
3	Connection elbow of the constant level oiler	4	Screw plug
5	Bearing bracket		

1. Pull out the vent plug (2).
2. Hinge down the reservoir of the constant level oiler (1) from the bearing bracket (5) and hold it in this position.
3. Fill in oil through the hole for the vent plug until the oil reaches the connection elbow of the constant level oiler (3).
4. Completely fill the reservoir of the constant level oiler (1).
5. Snap the constant level oiler (1) back into its operating position.
6. Fit the vent plug (2) again.
7. After approximately 5 minutes, check the oil level in the glass reservoir of the constant level oiler (1).
The oil reservoir must be properly filled at all times to provide a constant oil level. Repeat steps 1 - 6, if necessary.
8. To check the function of the constant level oiler (1), slowly drain some oil via the screw plug (4) until air bubbles can be seen in the oil reservoir.

NOTE

An excessively high oil level can lead to a temperature rise and to leakage of the fluid handled or oil.

6.1.3 Shaft seal

Shaft seals are fitted prior to delivery.

Observe the instructions on dismantling (⇒ Section 7.3.6, Page 40) or assembly (⇒ Section 7.4.3, Page 44) .

NOTE

When new plants are commissioned and a large amount of foreign matter is in the system, expect short service lives of the mechanical seal during the initial phase of plant operation.

NOTE

Only modify the specified sealing concepts and seal types after consultation with KSB.

Due to the complex conditions in hot water systems, the use of mechanical seals not approved by KSB shall not be covered by KSB's scope of warranty.

6.1.4 Priming and venting the pump

	CAUTION
	<p>Shaft seal failure caused by insufficient lubrication Damage to the pump!</p> <ul style="list-style-type: none"> ▷ Before starting up the pump set, vent the pump and suction line and prime both with the fluid to be handled.

1. Vent the pump and suction line and prime both with the fluid to be handled.
2. Fully open the shut-off element in the suction line.

Connection 6B can be used for venting (see drawing of auxiliary connections).

6.1.5 Final check

1. Remove the coupling guard and its footboard, if any.
2. Check the coupling alignment; re-align the coupling, if required.
(⇒ Section 5.6, Page 24)
3. Check proper functioning of coupling/shaft.
Check that coupling/shaft can be easily rotated by hand.
4. Fit the coupling guard and its footboard, if any.
5. Check the distance between coupling and coupling guard.
The coupling guard must not touch the coupling.

6.1.6 Start-up for testing

1. Set the selector switch at the control cabinet to manual operation.
2. Start up the motor.
3. Open the shut-off element in the test pipe.

6.1.7 Checking the shaft seal

Mechanical seal The mechanical seal only leaks slightly or invisibly (as vapour) during operation. Mechanical seals are maintenance-free.

Gland packing The gland packing must drip slightly during operation.
(Approximately 20 drops per minute)

Adjusting the leakage

- Prior to commissioning**
1. Only lightly tighten the nuts of the gland follower by hand.
 2. Use a feeler gauge to verify that the gland follower is mounted centred and at a right angle to the shaft.
- ⇒ The gland must leak after the pump has been primed.

After five minutes of operation

	WARNING
	<p>Unprotected rotating parts Risk of personal injury!</p> <ul style="list-style-type: none"> ▷ Do not touch rotating parts. ▷ When the pump is running, perform any work with utmost caution.

The leakage can be reduced.

1. Tighten the nuts on the gland follower by 1/6 turn.
2. Monitor the leakage for another five minutes.

Excessive leakage:

Repeat steps 1 and 2 until the minimum value has been reached.

Not enough leakage:

Slightly loosen the nuts at the gland follower.

No leakage:

Immediately switch off pump set!

Loosen the gland follower and repeat commissioning.

Checking the leakage

After the leakage has been adjusted, monitor the leakage for about two hours at maximum fluid temperature.

Check that enough leakage occurs at the gland packing at minimum fluid pressure.

6.1.8 Switching the pump set off after testing

1. Close the shut-off element in the test pipe.
2. Switch off the motor.
Make sure it runs down smoothly to a standstill.
3. Set the selector switch to automatic.

6.2 Operating limits

6.2.1 Ambient temperature

	CAUTION
	<p>Operation outside the permissible ambient temperature Damage to the pump (set)!</p> <p>▸ Observe the specified limits for permissible ambient temperatures.</p>

Observe the following parameters and values during operation:

Table 12: Permissible ambient temperatures

Permissible ambient temperature	Value
Maximum	40 °C
Minimum	See data sheet.

6.2.2 Frequency of starts

The frequency of starts is usually determined by the maximum temperature increase of the motor. This largely depends on the power reserves of the motor in steady-state operation and on the starting conditions (DOL, star-delta, moments of inertia, etc). If the starts are evenly spaced over the period indicated, the following limits serve as orientation for start-up with the discharge-side gate valve slightly open:

Table 13: Frequency of starts

Motor rating [kW]	Maximum frequency of starts [Starts/hour]
≤ 100	10
> 100	5

	CAUTION
	<p>Re-starting while motor is still running down Damage to the pump (set)!</p> <p>▷ Do not re-start the pump set before the pump rotor has come to a standstill.</p>

6.2.3 Fluid handled

6.2.3.1 Flow rate

Unless specified otherwise in the characteristic curves or in the data sheets, the following applies:

- Short-time operation: $Q_{\min}^{5)} = 0.1 \times Q_{\text{opt}}^{6)}$
- Continuous operation: $Q_{\min}^{5)} = 0.3 \times Q_{\text{opt}}^{6)}$
- 2-pole operation: $Q_{\max}^{7)} = 1.1 \times Q_{\text{opt}}^{6)}$
- 4-pole operation: $Q_{\max}^{7)} = 1.25 \times Q_{\text{opt}}^{6)}$

The data refer to water and water-like fluids. Longer operating periods with these fluids and at the flow rates indicated will not cause an additional increase in the temperatures on the pump surface. However, if the physical properties of the fluids handled differ from those of water, the calculation formula below must be used to check if an additional heat build-up may lead to a dangerous temperature increase at the pump surface. If necessary, the minimum flow must be increased.

$$T_o = T_f + \Delta \vartheta$$

$$\Delta \vartheta = \frac{g \times H}{c \times \eta} \times (1 - \eta)$$

Table 14: Key

Symbol	Description	Unit
c	Specific heat capacity	J/kg K
g	Gravitational constant	m/s ²
H	Pump discharge head	m
T _f	Fluid temperature	°C
T _o	Temperature at the casing surface	°C
η	Pump efficiency at duty point	-
Δϑ	Temperature difference	K

6.2.3.2 Density of the fluid handled

The pump input power changes in proportion to the density of the fluid handled.

	CAUTION
	<p>Impermissibly high density of the fluid handled Motor overload!</p> <p>▷ Observe the information on fluid density in the data sheet.</p> <p>▷ Make sure the motor has sufficient power reserves.</p>

5) Minimum permissible flow rate
6) Flow rate at best efficiency point
7) Maximum permissible flow rate

6.2.3.3 Abrasive fluids

Do not exceed the maximum permissible solids content specified in the data sheet. When the pump handles fluids containing abrasive substances, increased wear of the hydraulic system and shaft seal are to be expected. In this case, reduce the commonly recommended inspection intervals.

6.3 Shutdown/storage/preservation

6.3.1 Measures to be taken for shutdown

The pump (set) remains installed

- ✓ Sufficient fluid is supplied for the operation check run of the pump.
 1. Start up the pump (set) regularly between once a month and once every three months for approximately five minutes during prolonged shutdown periods. This will prevent the formation of deposits within the pump and the pump intake area.

The pump (set) is removed from the pipe and stored

- ✓ The pump has been properly drained and the safety instructions for dismantling the pump have been observed. (⇒ Section 7.3.1, Page 38)
 1. Spray-coat the inside wall of the pump casing and, in particular, the impeller clearance areas with a preservative.
 2. Spray the preservative through the suction and discharge nozzles. It is advisable to then close the pump nozzles (e.g. with plastic caps or similar).
 3. Oil or grease all exposed machined parts and surfaces of the pump (with silicone-free oil and grease, food-approved if required) to protect them against corrosion. Observe the additional instructions (⇒ Section 3.3, Page 12) .

If the pump set is to be stored temporarily, only preserve the wetted components made of low-alloy materials. Commercially available preservatives can be used for this purpose. Observe the manufacturer's instructions for application/removal.

Observe any additional instructions and information provided. (⇒ Section 3, Page 11)

6.4 Returning to service

For returning the equipment to service, observe the sections on commissioning/start-up (⇒ Section 6.1, Page 29) and the operating limits.

In addition, carry out all servicing/maintenance operations before returning the pump (set) to service. (⇒ Section 7, Page 35)

	<p>! WARNING</p>
	<p>Failure to re-install or re-activate protective devices Risk of injury from moving parts or escaping fluid!</p> <ul style="list-style-type: none"> ▸ As soon as the work is completed, re-install and re-activate any safety-relevant devices and protective devices.
	<p>NOTE</p>
	<p>If the pump has been out of service for more than one year, replace all elastomer seals.</p>

7 Servicing/Maintenance

7.1 Safety regulations

	CAUTION
	<p>Improperly serviced pump set Damage to the pump set!</p> <ul style="list-style-type: none"> ▷ Service the pump set regularly. ▷ Prepare a maintenance schedule with special emphasis on lubricants, shaft seal and coupling.

The operator ensures that maintenance, inspection and installation is performed by authorised, qualified specialist personnel who are thoroughly familiar with the manual.

	! WARNING
	<p>Unintentional starting of the pump set Risk of injury by moving components and shock currents!</p> <ul style="list-style-type: none"> ▷ Ensure that the pump set cannot be started unintentionally. ▷ Always make sure the electrical connections are disconnected before carrying out work on the pump set.

	! WARNING
	<p>Insufficient stability Risk of crushing hands and feet!</p> <ul style="list-style-type: none"> ▷ During assembly/dismantling, secure the pump (set)/pump parts to prevent tilting or tipping over.

A regular maintenance schedule will help avoid expensive repairs and contribute to trouble-free, reliable operation of the pump, pump set and pump parts with a minimum of servicing/maintenance expenditure and work.



	NOTE
	<p>All maintenance work, service work and installation work can be carried out by KSB Service or authorised workshops. For contact details please refer to the enclosed "Addresses" booklet or visit "www.ksb.com/contact" on the Internet.</p>

Never use force when dismantling and reassembling the pump set.

7.2 Servicing/inspection

7.2.1 Supervision of operation

	CAUTION
	<p>Excessive temperatures as a result of bearings running hot or defective bearing seals Damage to the pump set!</p> <ul style="list-style-type: none"> ▷ Regularly check the lubricant level. ▷ Regularly check the rolling element bearings for running noises.

	CAUTION
	<p>Increased wear due to dry running Damage to the pump set!</p> <ul style="list-style-type: none"> ▷ Never operate the pump set without liquid fill. ▷ Never close the shut-off element in the suction line and/or supply line during pump operation.
	CAUTION
	<p>Impermissibly high temperature of fluid handled Damage to the pump!</p> <ul style="list-style-type: none"> ▷ Prolonged operation against a closed shut-off element is not permitted (heating up of the fluid). ▷ Observe the temperature limits in the data sheet and in the section on operating limits.

While the pump is in operation, observe and check the following:

- The pump must run quietly and free from vibrations at all times.
- In case of oil lubrication, ensure the oil level is correct.
- Check the shaft seal.
- Check the static sealing elements for leakage.
- Check the rolling element bearings for running noises.
Vibrations, noise and an increase in current input occurring during unchanged operating conditions indicate wear.
- Monitor the correct functioning of any auxiliary connections.
- Monitor the bearing temperature.
The bearing temperature must not exceed 90 °C (measured on the outside of the bearing bracket).

	CAUTION
	<p>Operation outside the permissible bearing temperature Damage to the pump!</p> <ul style="list-style-type: none"> ▷ The bearing temperature of the pump (set) must never exceed 90 °C (measured on the outside of the bearing bracket).

False alarm pump operation

If the pump is started up due to false alarm with no fire-fighting water being drawn, it can be operated for a maximum of 48 hours. However, proper functioning of a by-pass line must be ensured through which a minimum flow is pumped in order to dissipate any excessive temperature rise.

After prolonged false-alarm operation, always dismantle the pump and inspect it for any signs of wear or damage; if necessary, repair it by replacing any affected components.

7.2.2 Inspection work

	CAUTION
	<p>Excessive temperatures caused by friction, impact or frictional sparks Damage to the pump set!</p> <ul style="list-style-type: none"> ▷ Regularly check the coupling guard, plastic components and other guards of rotating parts for deformation and sufficient distance from rotating parts.

7.2.2.1 Checking the coupling

Check the flexible elements of the coupling. Replace the relevant parts in due time if there is any sign of wear and check the alignment.

7.2.2.2 Cleaning filters

	CAUTION
	<p>Insufficient inlet pressure due to clogged filter in the suction line Damage to the pump!</p> <ul style="list-style-type: none"> ▷ Monitor contamination of filter with suitable means (e.g. differential pressure gauge). ▷ Clean filter at appropriate intervals.

7.2.3 Lubrication and lubricant change of rolling element bearings

	CAUTION
	<p>Excessive temperatures as a result of bearings running hot or defective bearing seals Damage to the pump set!</p> <ul style="list-style-type: none"> ▷ Regularly check the condition of the lubricant.

7.2.3.1 Oil lubrication

The rolling element bearings are usually lubricated with mineral oil.

7.2.3.1.1 Intervals

Table 15: Oil change intervals

Temperature at the bearing	First oil change	All subsequent oil changes ⁸⁾
up to 70 °C	After 300 operating hours	Every 8500 operating hours
70 °C - 80 °C	After 300 operating hours	Every 4200 operating hours
80 °C - 90 °C	After 300 operating hours	Every 2000 operating hours

7.2.3.1.2 Oil quality

Table 16: Oil quality

Designation	Symbol to DIN 51502	Properties	
		CLP46 lubricating oil to DIN 51517 or HD 20W/20 SAE	□
		Flash point (to Cleveland)	+175 °C
		Solidification point (pour point)	-15 °C
		Application temperature ⁹⁾	Higher than permissible bearing temperature

8) At least once a year



9) For ambient temperatures below -10 °C use a different suitable type of lubricating oil. Contact KSB.

7.2.3.1.3 Oil quantity

Table 17: Oil quantity

Pump size	Oil quantity [l]
65-315	approx. 0.5
80-315	
100-315	
125-315	

7.2.3.1.4 Changing the oil

	 WARNING
	<p>Lubricants posing a health hazard and/or hot lubricants Hazard to persons and the environment!</p> <ul style="list-style-type: none"> ▷ When draining the lubricant take appropriate measures to protect persons and the environment. ▷ Wear safety clothing and a protective mask, if required. ▷ Collect and dispose of any lubricants. ▷ Observe all legal regulations on the disposal of fluids posing a health hazard.

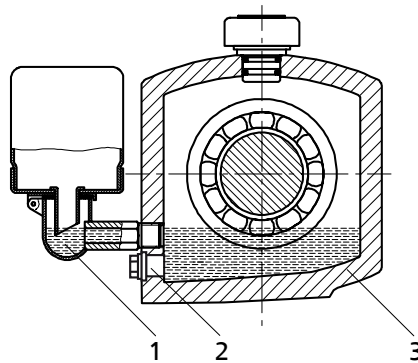



Fig. 15: Bearing bracket with constant level oiler



1	Constant level oiler	2	Screw plug
3	Bearing bracket		

- ✓ A suitable container for the used oil is on hand.
- 1. Place the container underneath the screw plug.
- 2. Undo the screw plug (2) at the bearing bracket (3) and drain the oil.
- 3. Once the bearing bracket (3) has been drained, re-insert and re-tighten the screw plug (2).
- 4. Re-fill with oil.

7.3 Dismantling the pump set

7.3.1 General information/Safety regulations

	 WARNING
	<p>Unqualified personnel performing work on the pump (set) Risk of injury!</p> <ul style="list-style-type: none"> ▷ Always have repair and maintenance work performed by specially trained, qualified personnel.

	⚠ WARNING
	<p>Hot surface Risk of injury!</p> <ul style="list-style-type: none"> ▷ Allow the pump set to cool down to ambient temperature.
	⚠ WARNING
	<p>Improper lifting/moving of heavy assemblies or components Personal injury and damage to property!</p> <ul style="list-style-type: none"> ▷ Use suitable transport devices, lifting equipment and lifting tackle to move heavy assemblies or components.

Observe the general safety instructions and information. (⇒ Section 7, Page 35)

For any work on the motor, observe the instructions of the relevant motor manufacturer.

For dismantling and reassembly refer to the general assembly drawing. (⇒ Section 9.1, Page 51)



In the event of damage you can always contact our service staff.

	⚠ DANGER
	<p>Insufficient preparation of work on the pump (set) Risk of injury!</p> <ul style="list-style-type: none"> ▷ Properly shut down the pump set. ▷ Close the shut-off elements in suction and discharge line. ▷ Drain the pump and release the pump pressure. ▷ Close any auxiliary connections. ▷ Allow the pump set to cool down to ambient temperature.

7.3.2 Preparing the pump set

1. Interrupt the power supply and secure the pump against unintentional start-up.
2. Disconnect and remove all auxiliary pipework.
3. Remove the coupling guard.
4. Remove the coupling spacer, if any.
5. Drain the oil fill of oil-lubricated bearings. (⇒ Section 7.2.3.1.4, Page 38)

7.3.3 Removing the motor

	NOTE
	<p>On pump sets with spacer-type couplings, the back pull-out unit can be removed while the motor remains bolted to the baseplate.</p>
	⚠ WARNING
	<p>Motor tilting Risk of crushing hands and feet!</p> <ul style="list-style-type: none"> ▷ Suspend or support the motor to prevent it from tilting.

1. Disconnect the motor from the power supply.
2. Unbolt the motor from the baseplate.
3. Shift the motor to separate it from the pump.

7.3.4 Removing the back pull-out unit

- ✓ Pumps without spacer-type coupling: the motor has been removed.

	! WARNING
	Back pull-out unit tilting Risk of crushing hands and feet! ▷ Suspend or support the bearing bracket at the pump end.

1. If required, suspend or support bearing bracket 330 to prevent it from tipping over.
2. Unbolt support foot 183 from the baseplate.
3. Undo hexagon nut 920.01 at the volute casing.
4. Pull the back pull-out unit out of the volute casing.
5. Remove and dispose of joint ring 411.10.
6. Place the back pull-out unit on a clean and level surface.

7.3.5 Removing the impeller

- ✓ The notes and steps stated in (⇒ Section 7.3.1, Page 38) to (⇒ Section 7.3.4, Page 40) have been observed/carried out.
 - ✓ The back pull-out unit is kept in a clean and level assembly area.
1. Undo impeller nut 922 (right-hand thread).
 2. Remove impeller 230 with an impeller removal tool.
 3. Place impeller 230 on a clean and level surface.
 4. Remove keys 940.01 from shaft 210.
 5. Remove and dispose of joint rings 411.31/411.32.

7.3.6 Removing the shaft seal

7.3.6.1 Removing the mechanical seal

- ✓ The notes and steps stated in (⇒ Section 7.3.1, Page 38) to (⇒ Section 7.3.5, Page 40) have been observed/carried out.
 - ✓ The back pull-out unit is kept in a clean and level assembly area.
1. Undo hexagon nuts 920.02 and slide back seal cover 471.01 (if fitted) until it rests against thrower 507.01.
 2. Remove casing cover 161 with O-ring 412.01.
 3. Remove and dispose of O-ring 412.01.
 4. Pull complete mechanical seal 433 with shaft protecting sleeve 524.01, seal cover 471 and thrower 507.01 off shaft 210.

7.3.6.2 Dismantling the gland packing

- ✓ The notes and steps stated in (⇒ Section 7.3.1, Page 38) to (⇒ Section 7.3.5, Page 40) have been observed/carried out.
 - ✓ The back pull-out unit is kept in a clean and level assembly area.
1. Unscrew hexagon nuts 920.02 at gland follower 452 and remove the gland follower.
 2. Remove stuffing box ring 454.01 and drip plate 463.01.
 3. Remove casing cover 161 with O-ring 412.01 and gland packing 461.01.
 4. Remove packing rings 461.01 and lantern ring 458.01, if any, from the packing chamber.

5. Pull off guard 680.
6. Pull shaft protecting sleeve 524.01 and thrower 507.01 off shaft 210.

7.3.7 Dismantling the bearings

- ✓ The notes and steps stated in (⇒ Section 7.3.1, Page 38) to (⇒ Section 7.3.6, Page 40) have been observed/carried out.
- ✓ The bearing bracket has been placed in a clean and level assembly area.
 1. Unscrew hexagon nuts 920.04 at the flange of bearing bracket lantern 344.
 2. Remove bearing bracket lantern 344.
 3. Undo the hexagon socket head cap screw in the coupling hub.
 4. Pull the coupling half off the pump shaft with a puller.
 5. Remove key 940.02.
 6. Undo screws 914.02 and remove motor-end bearing cover 360.02 and joint ring 400.02.
 7. Undo screws 914.01 and remove pump-end bearing cover 360.01 and joint ring 400.01.
 8. Carefully drive shaft 210 together with angular contact ball bearing 320.02 and the inner ring of cylindrical roller bearing 322.01 out of the bearing bracket towards the drive end.
 9. Remove support disc 550.23 of angular contact ball bearing 320.02 from bearing bracket 330.
 10. Remove cylindrical roller bearing 322.01 (roller cage) from bearing bracket 330.
 11. Bend open lock washer 931.01 behind slotted round nut 920.21 on shaft 210.
 12. Unscrew slotted round nut 920.21 (right-hand thread) and remove lock washer 931.01.

	⚠ WARNING
	<p>Hot surfaces due to heating of components for assembly/dismantling Risk of burns!</p> <ul style="list-style-type: none"> ▷ Wear heat-resistant protective gloves. ▷ Remove flammable substances from the danger zone.

13. Heat up angular contact ball bearing 320.02 and the inner ring of cylindrical roller bearing 322.01 to 80 °C, and pull them off shaft 210.
14. Dispose of joint rings 400.01/02.

7.4 Reassembling the pump set

7.4.1 General information/Safety regulations

	⚠ WARNING
	<p>Improper lifting/moving of heavy assemblies or components Personal injury and damage to property!</p> <ul style="list-style-type: none"> ▷ Use suitable transport devices, lifting equipment and lifting tackle to move heavy assemblies or components.

	CAUTION
	<p>Improper reassembly Damage to the pump!</p> <ul style="list-style-type: none"> ▷ Reassemble the pump (set) in accordance with the general rules of sound engineering practice. ▷ Use original spare parts only.

Sequence Always reassemble the pump in accordance with the corresponding general assembly drawing.

- Sealing elements**
- **Gaskets**
 - Always use new gaskets, making sure that they have the same thickness as the old ones.
 - Always fit gaskets of asbestos-free materials or graphite without using lubricants (e.g. copper grease, graphite paste).
 - **O-rings**
 - Never use O-rings that have been made by cutting an O-ring cord to size and gluing the ends together.
 - **Packing rings**
 - Always use pre-compressed packing rings.



	CAUTION
	<p>Contact of O-ring with graphite or similar material Fluid could escape!</p> <ul style="list-style-type: none"> ▷ Do not coat O-ring with graphite or similar material. ▷ Use animal fats or lubricants based on silicone or PTFE.

- **Assembly adhesives**
 - For gaskets, avoid the use of assembly adhesives if possible.
 - If assembly adhesives are required, use a commercially available contact adhesive (e.g. "Pattex").
 - Only apply adhesive at selected points and in thin layers.
 - Never use quick-setting adhesives (cyanoacrylate adhesives).
 - Coat the locating surfaces of the individual components and screwed connections with graphite or similar before reassembly.
 - Prior to reassembly, screw back any forcing screws and adjusting screws.

Tightening torques For reassembly, tighten all screws and bolts as specified in this manual.

7.4.2 Installing the bearings

- ✓ The individual parts have been placed in a clean and level assembly area.
- ✓ All dismantled parts have been cleaned and checked for wear.
- ✓ Any damaged or worn parts have been replaced by original spare parts.
- ✓ The sealing surfaces have been cleaned.

	 WARNING
	<p>Hot surfaces due to heating of components for assembly/dismantling</p> <p>Risk of burns!</p> <ul style="list-style-type: none"> ▷ Wear heat-resistant protective gloves. ▷ Remove flammable substances from the danger zone.

1. Heat up angular contact ball bearing 320.02 and the inner ring of cylindrical roller bearing 322.01 to approx. 80 °C in an oil bath.
2. Slide angular contact ball bearing 320.02 and the inner ring of cylindrical roller bearing 322.01 onto shaft 210 until they will not go any further.

	NOTE
	<p>Angular contact ball bearings must be installed in back-to-back arrangement. Angular contact ball bearings installed in pairs must always be from the same manufacturer.</p>

3. Use a C-spanner to tighten slotted round nut 920.21 without lock washer 931.01.
4. Let angular contact ball bearing 320.01 cool down to approximately 5 °C above ambient temperature.
5. Re-tighten slotted round nut 920.21, then unscrew it again.
6. Apply a few spots of a suitable lubricant (e.g. Molykote) to the contact faces of lock washer 931.01 and slotted round nut 920.21.
7. Fit lock washer 931.01.
8. Tighten slotted round nut 920.21.
9. Bend back lock washer 931.01.
10. Insert circlip 932.01/932.02 into the bearing bracket.
11. Fit cylindrical roller bearing 322.01 (roller cage) in the bearing bracket.
12. Insert support disc 550.23 of angular contact ball bearing 320.02 into bearing bracket 330.
13. Carefully insert pre-assembled shaft 210 with angular contact ball bearing 320.02 and the inner ring of cylindrical roller bearing 322.01 into bearing bracket 330 from the drive end.
14. Fit pump-end bearing cover 360.01 with joint ring 400.01; take care not to damage lip seal 421.01.
15. Fit motor-end bearing cover 360.02 with joint ring 400.02; take care not to damage lip seal 421.02.
16. Fit bearing bracket lantern 344.
17. Tighten hex. nuts 920.04 at the flange of bearing bracket lantern 330.
18. Fit keys 940.02.
19. Slide the coupling hub onto the shaft end.
20. Secure the coupling hub with a hexagon socket nut.
21. Fit thrower 507.01, if any.

7.4.3 Fitting the shaft seal

7.4.3.1 Installing the mechanical seal

The following rules must be observed when installing the mechanical seal:

- For installing the mechanical seal, proceed as shown in the seal installation drawing.
 - Work cleanly and accurately.
 - Only remove the protective wrapping of the contact faces immediately before installation takes place.
 - Prevent any damage to the sealing surfaces or O-rings.
 - After inserting the stationary ring of the mechanical seal, check that it is plane-parallel in relation to the casing part.
 - The surface of the shaft protecting sleeve must be absolutely clean and smooth, and the sleeve's mounting edge must be chamfered.
 - When sliding the rotating assembly onto the shaft protecting sleeve, take appropriate steps to protect the surface of the shaft protecting sleeve from damage.
- ✓ The notes and steps stated in (⇒ Section 7.4.1, Page 41) to (⇒ Section 7.4.2, Page 42) have been observed/carried out.
 - ✓ The bearing assembly and the individual parts of mechanical seal 433 are kept in a clean and level assembly area.
 - ✓ All dismantled parts have been cleaned and checked for wear.
 - ✓ Any damaged or worn parts have been replaced by original spare parts.
 - ✓ The sealing surfaces have been cleaned.
1. Slide thrower 507.01 (if any) onto shaft 210 from the pump end.
 2. Fasten seal cover 471 with inserted O-ring and the stationary ring of the mechanical seal to casing cover 161 with hexagon nut 920.02.
 3. Insert casing cover 161 with O-ring 412.01 into lantern 344; watch joint ring 411.11.
 4. Fit the rotating assembly of mechanical seal 433 on shaft protecting sleeve 524.01 (observe distance B - see Supplementary Sheet of the mechanical seal).
 5. Slide pre-assembled mechanical seal 433 and shaft protecting sleeve 524.01 onto shaft 210.

7.4.3.2 Packing the gland

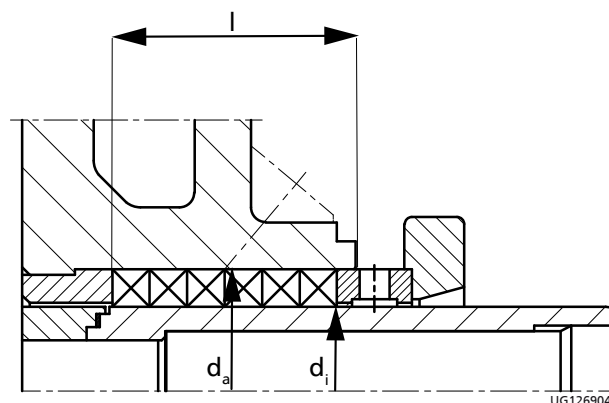

Fig. 16: Gland packing chamber

Table 18: Gland packing chamber

Pump size	Gland packing chamber			Packing cross-section	Number of packing rings
	$\varnothing d_i$	$\varnothing d_a$	l		
65-315	55	75	64	10 x 10	6

Pump size	Gland packing chamber			Packing cross-section	Number of packing rings
	$\varnothing d_i$	$\varnothing d_a$	l		
80-315	55	75	64	10 x 10	6
100-315					
125-315	70	95	65,5	12.5 x 12.5	5

Always use pre-compressed packing rings.

- ✓ The notes and steps stated in (⇒ Section 7.4.1, Page 41) to (⇒ Section 7.4.2, Page 42) have been observed/carried out.
- ✓ The bearing assembly as well as the individual parts are kept in a clean and level assembly area.
- ✓ All disassembled parts have been cleaned and checked for wear.
- ✓ Any damaged or worn parts have been replaced by original spare parts.
- ✓ The sealing surfaces have been cleaned.
 1. Clamp casing cover 161 into a vice.
 2. Press in neck bush 456.01.
 3. Insert the first packing ring, ensuring that its cut edge is in horizontal position.
 4. Hold the packing ring in place and slide shaft protecting sleeve 524 (chamfered side first) into the gland packing chamber from the pump end.
 5. Slightly expand the inside diameter of the packing ring by moving shaft protecting sleeve 524 back and forth. Then pull out the shaft protecting sleeve. Insert lantern ring 458, if any. Insert subsequent packing rings one at a time, with their joints staggered at approximately 90°. Repeat the expansion procedure. When the last packing ring has been inserted, shaft protecting sleeve 524 remains in the packing chamber.
 6. Insert stuffing box ring 454.01 with the drilled hole down.
 7. Fit gland follower 452 and lightly fasten it by hand with the two hexagon nuts 920.02; watch discs 550.01.
 8. Fit guard 680.
 9. Install complete discharge cover 161 with shaft protecting sleeve 524 in the pump; take care not to damage joint ring 411.11.

7.4.4 Fitting the impeller

- ✓ The notes and steps stated in (⇒ Section 7.4.1, Page 41) to (⇒ Section 7.4.3, Page 44) have been observed/carried out.
- ✓ The assembled bearing/mechanical seal as well as the individual parts are kept in a clean and level assembly area.
- ✓ All dismantled components have been cleaned and checked for wear.
- ✓ Any damaged or worn parts have been replaced by original spare parts.
- ✓ The sealing surfaces have been cleaned.
- ✓ Impeller bore, shaft and keyways are clean and free from burrs.
 1. Insert keys 940.01 into the shaft keyway.
 2. Insert joint ring 411.32.
 3. Coat the impeller with a suitable lubricant.
 4. Slip impeller 230 onto shaft 210.
 5. Insert joint ring 411.31.
 6. Screw impeller nut 922 to shaft 210.

7.4.5 Fitting the back pull-out unit

	WARNING
	<p>Back pull-out unit tilting Risk of crushing hands and feet!</p> <p>▸ Suspend or support the bearing bracket at the pump end.</p>

- ✓ The notes and steps stated in (⇒ Section 7.4.1, Page 41) to (⇒ Section 7.4.4, Page 45) have been observed/carried out.
- ✓ Any damaged or worn parts have been replaced by original spare parts.
- ✓ The sealing surfaces have been cleaned.
- ✓ For back pull-out units supplied without coupling: Fit the coupling in accordance with the manufacturer's instructions.
 1. If required, suspend or support the back pull-out unit to prevent it from tilting. Then slide it into volute casing 102 with a new gasket 411.10.
 2. Tighten nut 920.01 at the volute casing.
 3. Bolt support foot 183 to the baseplate.

7.4.6 Mounting the motor

	NOTE
	<p>Steps 1 and 2 do not apply to versions with spacer-type coupling.</p>

1. Shift the motor to connect it to the pump via the coupling.
2. Fasten the motor to the baseplate.
3. Align pump and motor. (⇒ Section 5.7, Page 24)
4. Connect the motor to the power supply (refer to manufacturer's product literature).

7.5 Tightening torques

7.5.1 Tightening torques

Use a torque wrench to tighten the bolted connections (902.01/920.01) between the volute casing and the bearing bracket lantern.

Table 19: Tightening forces [Nm] for screwed connections

Thread	Brand-new threads ¹⁰⁾	-15 % ¹¹⁾	-20 % ¹¹⁾
M16	155	131,7	124

7.5.2 Tightening torques for the impeller nut

Observe the following tightening torques for impeller nut (922):

Table 20: Tightening torques for the impeller nut

Thread size[mm]	Tightening torque M _A [Nm]
M 20x1,5	200

Re-tighten the impeller nut some 20 to 30 minutes after assembly.

10) These values are determined on the basis of a friction coefficient of $\mu = 0.12$.

11) After repeated tightening of the threads and in case of good lubrication the values shall be reduced by 15 to 20 %.

7.6 Spare parts stock

7.6.1 Ordering spare parts

Always quote the following data when ordering replacement or spare parts:

- Order number
- Order item number
- Type series
- Size
- Material variant
- Year of construction

Refer to the name plate for all data.

Also specify the following data:

- Part number and description
- Quantity of spare parts
- Shipping address
- Mode of dispatch (freight, mail, express freight, air freight)

7.6.2 Recommended spare parts stock for 2 years' operation to DIN 24296

Table 21: Quantity of spare parts for recommended spare parts stock

Part No.	Description	Number of pumps (including stand-by pumps)							10 and more
		2	3	4	5	6 and 7	8 and 9		
210	Shaft	1	1	1	2	2	2	20 %	
230	Impeller	1	1	1	2	2	2	20 %	
320.02	Angular contact ball bearing (set)	1	1	2	2	2	3	25 %	
322.01	Cylindrical roller bearing	1	1	2	2	2	3	25 %	
502.01	Casing wear ring	2	2	2	3	3	4	50 %	
524.01	Shaft protecting sleeve	2	2	2	3	3	4	50 %	
-	Gaskets for pump casing (set)	4	6	8	8	9	12	150 %	
-	Torque-transmitting coupling elements (set)	1	1	2	2	3	4	30 %	
For variants with mechanical seal:									
433	Mechanical seal complete	1	1	2	2	2	3	25 %	
For variants with gland packing:									
456.01	Neck bush	1	1	2	2	2	3	30 %	
461.01	Gland packing (set)	4	4	6	6	6	8	100 %	

7.6.3 Interchangeability of pump components

Table 22: Interchangeability of pump components

Bearing bracket	Pump size	Description																	
		Casing cover	Support foot	Shaft	Angular contact ball bearing	Cylindrical roller bearing	Bearing bracket	Bearing bracket lantern	Casing wear ring	Thrower	Shaft protecting sleeve	Impeller nut	Mechanical seal	Seal cover	Gland follower	Stuffing box ring	Neck bush	Lantern ring	Gland packing
		Part No.																	
		161	183	210	320.02	322.01	330	344	502.01	507.01	524.01	922	433	471.01	452.01	454.01	456.01	458.01	461.01
UP04	65-315	1	1	1	1	1	1	1	1	1	1	1	1	1	1	1	1	1	1
	80-315	2	2	1	1	1	1	1	2	1	1	1	1	1	1	1	1	1	1
	100-315	3	2	1	1	1	1	1	3	1	1	1	1	1	1	1	1	1	1
	125-315	4	3	2	2	2	2	2	4	2	2	1	2	2	2	2	2	2	2

8 Trouble-shooting

	WARNING
	<p>Improper work to remedy faults Risk of injury!</p> <p>▷ For any work performed to remedy faults, observe the relevant information given in this operating manual and/or in the product literature provided by the accessories manufacturer.</p>

If problems occur that are not described in the following table, consultation with the KSB customer service is required.

- A** Pump delivers insufficient flow rate
- B** Motor is overloaded
- C** Excessive discharge pressure
- D** Increased bearing temperature
- E** Leakage at the pump
- F** Excessive leakage at the shaft seal
- G** Vibrations during pump operation
- H** Impermissible temperature increase in the pump

Table 23: Trouble-shooting

A	B	C	D	E	F	G	H	Possible cause	Remedy ¹²⁾
X	-	-	-	-	-	-	-	Pump delivers against an excessively high pressure.	Re-adjust to duty point. Check system for impurities. Fit a larger impeller. ¹³⁾ Increase the speed (turbine, I.C. engine).
X	-	-	-	-	-	X	X	Pump or piping are not completely vented or primed.	Vent and/or prime.
X	-	-	-	-	-	-	-	Supply line or impeller clogged	Remove deposits in the pump and/or piping.
X	-	-	-	-	-	-	-	Formation of air pockets in the piping	Alter piping layout. Fit vent valve.
X	-	-	-	-	-	X	X	Suction lift is too high/NPSH _{available} (positive suction head) is too low.	Check/alter fluid level. Install pump at a lower level. Fully open the shut-off element in the suction line. Change suction line, if the friction losses in the suction line are too high. Check any strainers installed/suction opening. Observe permissible speed of pressure fall.
X	-	-	-	-	-	-	-	Air intake at the shaft seal	Fit new shaft seal.
X	-	-	-	-	-	-	-	Wrong direction of rotation	Check the electrical connection of the motor and the control system if any.
X	-	-	-	-	-	-	-	Speed is too low. ¹³⁾ - Operation with frequency inverter - Operation without frequency inverter	- Increase voltage/frequency at the frequency inverter within the permissible range. - Check voltage.
X	-	-	-	-	-	X	-	Impeller	Replace worn components by new ones.
-	X	-	-	-	-	X	-	Pump back pressure is lower than specified in the purchase order	Re-adjust to duty point. In the case of persistent overloading, turn down impeller. ¹³⁾
-	X	-	-	-	-	-	-	Density or viscosity of fluid handled higher than stated in purchase order	Contact KSB.

12) Pump pressure must be released before attempting to remedy faults on parts which are subjected to pressure.

13) Contact KSB.

A	B	C	D	E	F	G	H	Possible cause	Remedy ¹²⁾
-	X	-	-	-	X	-	-	Gland follower over-tightened or cocked	Correct.
-	X	X	-	-	-	-	-	Speed too high	Reduce speed. ¹³⁾
-	-	-	-	X	-	-	-	Defective gasket	Fit new gasket between volute casing and discharge cover.
-	-	-	-	-	X	-	-	Worn shaft seal	Fit new shaft seal.
X	-	-	-	-	X	-	-	Score marks or roughness on shaft protecting sleeve / shaft sleeve	Replace shaft protecting sleeve/shaft sleeve. Fit new shaft seal.
-	-	-	-	-	X	-	-	Vibrations during pump operation	Correct suction conditions. Re-align the pump. Re-balance the impeller. Increase pressure at the pump suction nozzle.
-	-	-	X	-	X	X	-	The pump set is misaligned.	Re-align.
-	-	-	X	-	X	X	-	Pump is warped or sympathetic vibrations in the piping.	Check the piping connections and secure fixing of pump; if required, reduce distances between the pipe clamps. Fix the pipelines using anti-vibration material.
-	-	-	X	-	-	X	-	Insufficient or excessive quantity of lubricant or unsuitable lubricant	Top up, reduce or change lubricant.
-	-	-	X	-	-	-	-	Non-compliance with specified coupling distance	Correct the distance according to the general arrangement drawing.
X	X	-	-	-	-	-	-	Motor is running on two phases only.	Replace the defective fuse. Check the electric cable connections.
-	-	-	-	-	-	X	-	Rotor out of balance	Clean the impeller. Re-balance the impeller.
-	-	-	-	-	-	X	-	Defective bearing(s)	Fit new bearing(s).
-	-	-	-	-	-	X	X	Flow rate is too low.	Increase the minimum flow rate.
-	-	-	-	-	X	-	-	Incorrect inflow of circulation liquid	Increase the free cross-section.

9 Related Documents

9.1 General assembly drawing

9.1.1 General assembly drawing CPKN -SX 65-315, 80-315, 100-315

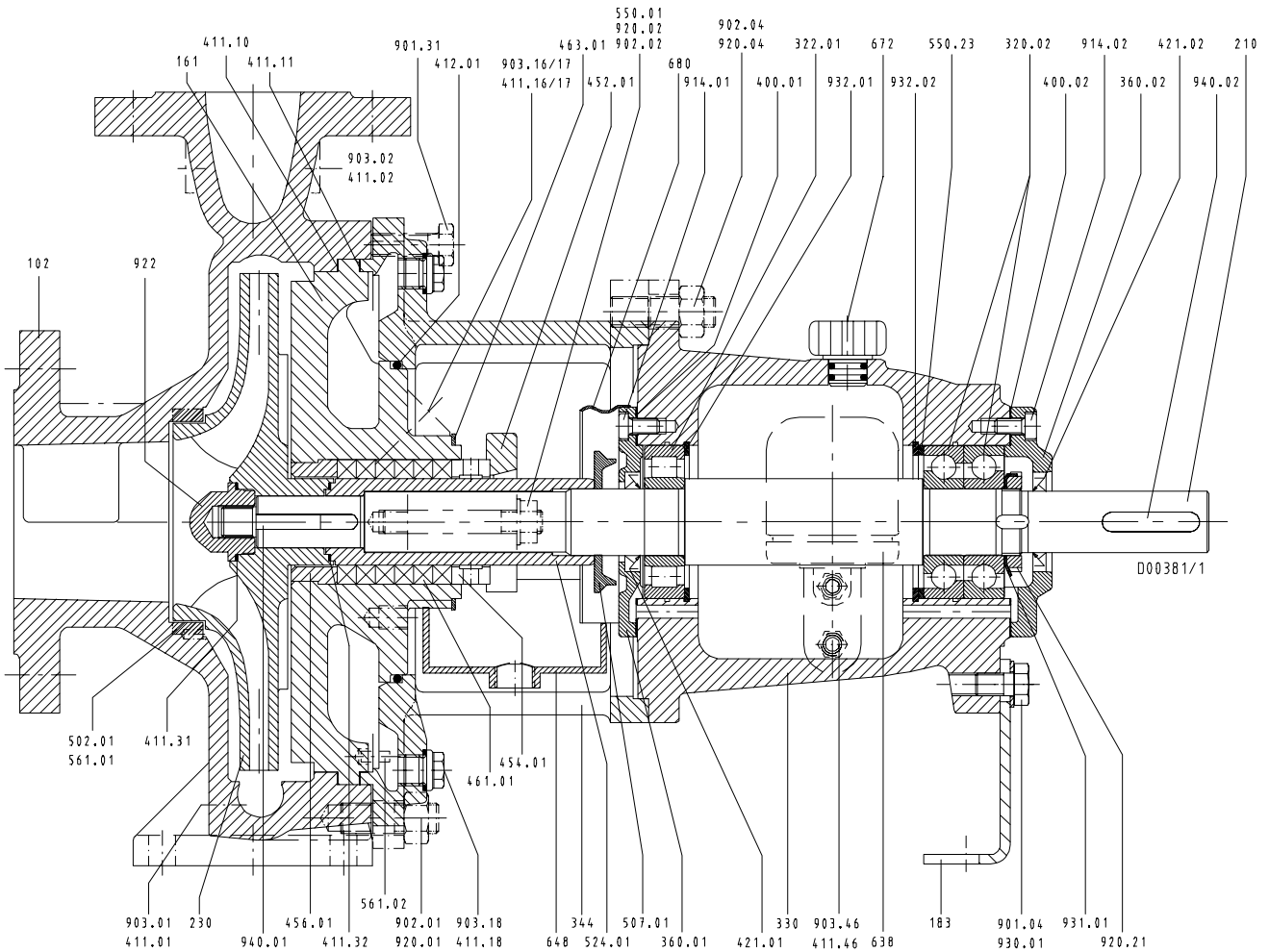

Fig. 17: General assembly drawing CPKN -SX 65-315, 80-315, 100-315

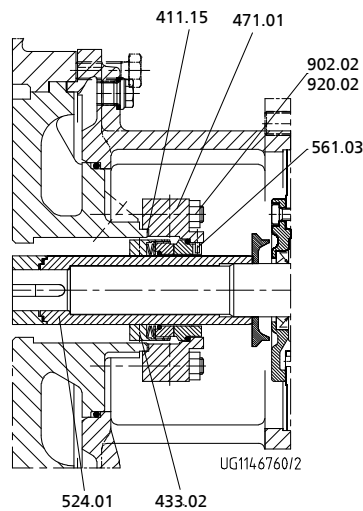

Fig. 18: Mechanical seal with cylindrical casing cover

- 14) Joint ring 411.10 depends on application temperature. Order separately in spare parts order.
- 15) For bearing brackets UP02 and UP04: socket head cap screw 914.04

Table 24: List of components

Part No.	Description	Scope of supply
102	Volute casing	with joint ring 411.01/03, joint ring 411.10 ¹⁴⁾ , stud 902.01, screwed plug 903.01/03, hexagon nut 920.01
161	Casing cover	with joint ring 411.11/16/17, O-ring 412.01, drip plate 463.01, disc 550.01, stud 902.02, screwed plug 903.16/17, hexagon nut 920.02
183	Support foot	with hexagon head bolt 901.04 ¹⁵⁾ , spring washer 930.01
210	Shaft	with set of adjusting washers 550.13, keywayed nut 920.21, lockwasher 931.01, key 940.01/02
230	Impeller	with joint ring 411.32
320.02	Angular contact ball bearing	
322.01	Cylindrical roller bearing	
330	Bearing bracket	
330	Bearing bracket (compl.)	with bearing cover 360.01/02, gasket 400.01/02, joint ring 411.46, lip seal 421.01/02, support disc 550.23, constant-level oiler 638, vent plug 672, screwed plug 903.46, socket head cap screw 914.01/02, circlip 932.01/02
344	Bearing bracket lantern	with joint ring 411.18, O-ring 412.01, grooved pin 561.02, screwed plug 903.46, stud 902.04, hexagon head bolt 901.31, hexagon nut 920.04
360.01/02	Bearing cover	with gasket 400.01/02, socket head cap screw 914.01/02
411.02/16/17	Joint ring	
421.01/02	Lip seal	
433	Mechanical seal	
452.01	Gland follower	
454.01	Stuffing box ring	
456.01	Neck bush	
458.01	Lantern ring	
461.01	Gland packing	
463.01	Drip plate	
471.01	Seal cover	with joint ring 411.15, grooved pin 561.03
502.01	Casing wear ring	
507.01	Thrower	
524.01	Shaft protecting sleeve	with joint ring 411.32
561.01	Grooved pin	
638	Constant-level oiler	
648	Drip pan	
680	Guard	
903.02/17/18	Screwed plug	
922	Impeller nut	with joint ring 411.31

9.1.2 General assembly drawing CPKN-SX 125-315

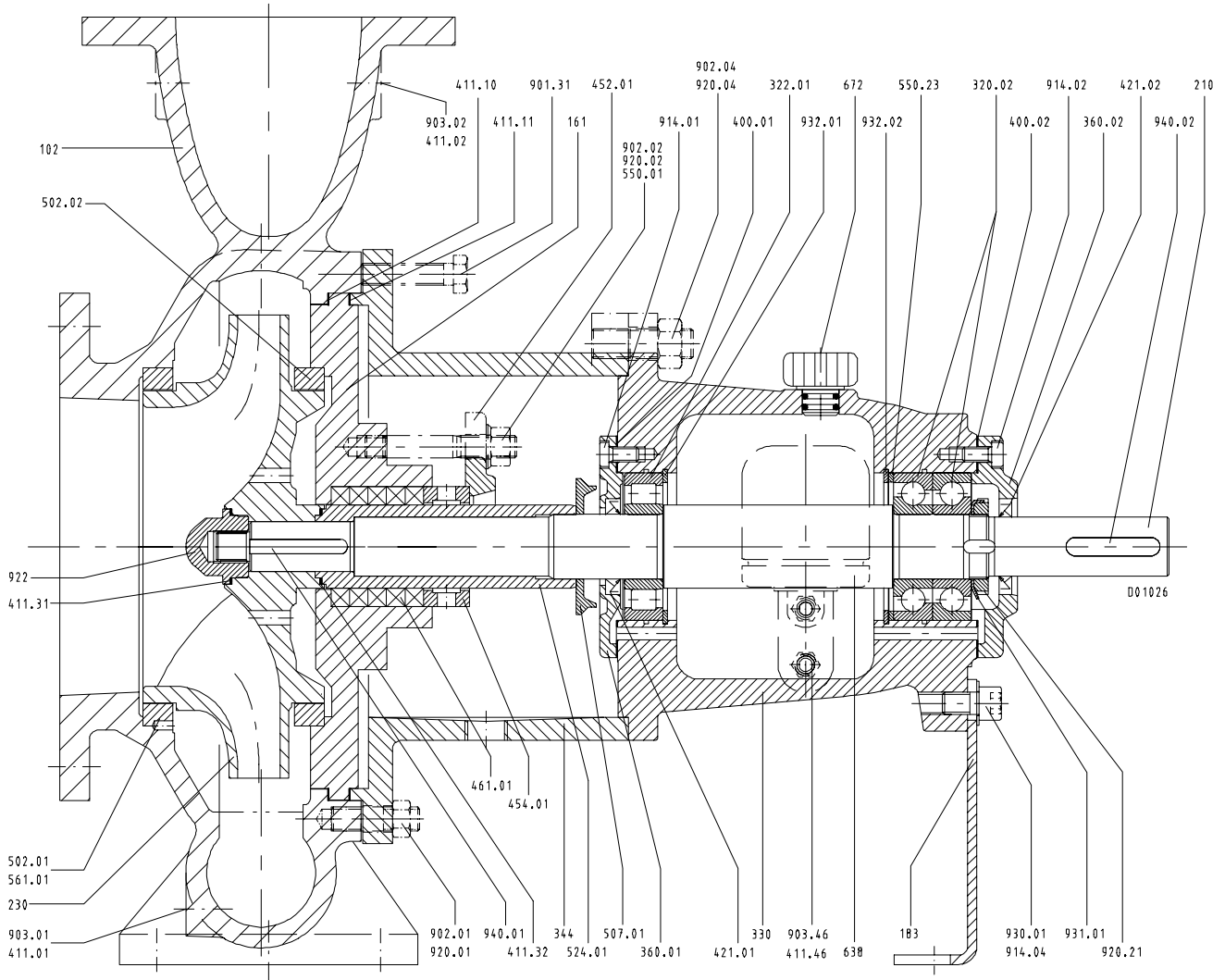

Fig. 19: General assembly drawing CPKN-SX 125-315

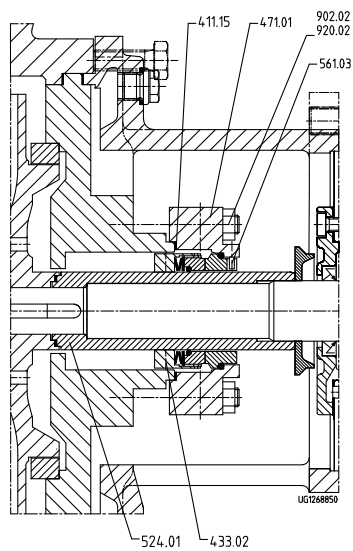

Fig. 20: Mechanical seal

- 16) Joint ring 411.10 depends on application temperature. Order separately in spare parts order.
- 17) For bearing brackets UP02 and UP04: socket head cap screw 914.04

Table 25: List of components

Part No.	Description	Scope of supply
102	Volute casing	with joint ring 411.01/03, joint ring 411.10 ¹⁶⁾ , stud 902.01, screwed plug 903.01/03, hexagon nut 920.01
161	Casing cover	with joint ring 411.11/16/17, O-ring 412.01, drip plate 463.01, disc 550.01, stud 902.02, screwed plug 903.16/17, hexagon nut 920.02
183	Support foot	with hexagon head bolt 901.04 ¹⁷⁾ , spring washer 930.01
210	Shaft	with set of adjusting washers 550.13, keywayed nut 920.21, lockwasher 931.01, key 940.01/02
230	Impeller	with joint ring 411.32
320.02	Angular contact ball bearing	
322.01	Cylindrical roller bearing	
330	Bearing bracket	
330	Bearing bracket (compl.)	with bearing cover 360.01/02, gasket 400.01/02, joint ring 411.46, lip seal 421.01/02, support disc 550.23, constant-level oiler 638, vent plug 672, screwed plug 903.46, socket head cap screw 914.01/02, circlip 932.01/02
344	Bearing bracket lantern	with joint ring 411.18, O-ring 412.01, grooved pin 561.02, screwed plug 903.46, stud 902.04, hexagon head bolt 901.31, hexagon nut 920.04
360.01/02	Bearing cover	with gasket 400.01/02, socket head cap screw 914.01/02
411.02	Joint ring	
421.01/02	Lip seal	
433	Mechanical seal	
452.01	Gland follower	
454.01	Stuffing box ring	
461.01	Gland packing	
471.01	Seal cover	with joint ring 411.15, grooved pin 561.03
502.01/02	Casing wear ring	
507.01	Thrower	
524.01	Shaft protecting sleeve	with joint ring 411.32
561.01	Grooved pin	
638	Constant-level oiler	
903.02	Screwed plug	
922	Impeller nut	with joint ring 411.31

10 EU Declaration of Conformity

Manufacturer: **KSB SE & Co. KGaA**
Johann-Klein-Straße 9
67227 Frankenthal (Germany)

The manufacturer herewith declares that **the product:**

CPKN-SX

KSB order number:

- is in conformity with the provisions of the following Directives as amended from time to time:
 - Pump (set): Machinery Directive 2006/42/EC

The manufacturer also declares that

- the following harmonised international standards have been applied:
 - ISO 12100
 - EN 809

Person authorised to compile the technical file:

Name
Function
Address (company)
Address (Street, No.)
Address (post or ZIP code, city) (country)

The EU Declaration of Conformity was issued in/on:

Place, date

.....¹⁸⁾.....
Name
Function
Company
Address

18) A signed, legally binding EU Declaration of Conformity is supplied with the product.

11 Certificate of Decontamination

Type:
Order number/
Order item number¹⁹⁾:
Delivery date:
Field of application:
Fluid handled¹⁹⁾:

Please tick where applicable¹⁹⁾:



Radioactive



Explosive



Corrosive



Toxic



Harmful



Bio-hazardous



Highly flammable



Safe

Reason for return¹⁹⁾:
Comments:
.....

The product/accessories have been carefully drained, cleaned and decontaminated inside and outside prior to dispatch/ placing at your disposal.

We herewith declare that this product is free from hazardous chemicals, biological and radioactive substances.

For mag-drive pumps, the inner rotor unit (impeller, casing cover, bearing ring carrier, plain bearing, inner rotor) has been removed from the pump and cleaned. In cases of containment shroud leakage, the outer rotor, bearing bracket lantern, leakage barrier and bearing bracket or adapter have also been cleaned.

For canned motor pumps, the rotor and plain bearing have been removed from the pump for cleaning. In cases of leakage at the stator can, the stator space has been examined for fluid leakage; if fluid handled has penetrated the stator space, it has been removed.

- No special safety precautions are required for further handling.
- The following safety precautions are required for flushing fluids, fluid residues and disposal:

.....
.....

We confirm that the above data and information are correct and complete and that dispatch is effected in accordance with the relevant legal provisions.

.....
Place, date and signature

.....
Address

.....
Company stamp

19) Required fields

Index

A

Abrasive fluids 34
 Auxiliary connections 23

B

Bearing temperature 36
 Bearings 15

C

Certificate of decontamination 56
 Commissioning/start-up 29
 Constant level oiler 29
 Contact guard 17
 Coupling 17, 37
 Coupling alignment 24

D

Design 14
 Designation 14
 Direction of rotation 28
 Disassembly 39
 Disposal 13
 Drive 17

E

Event of damage
 Ordering spare parts 47

F

Filter 22, 37
 Final check 31
 Flow rate 33
 Fluid handled
 Density 33
 Frequency of starts 32

G

General assembly drawing 52, 54
 Gland packing 31

I

Impeller type 15
 Installation
 Installation on a foundation 18, 19
 Installation without foundation 20
 Installation at site 18
 Intended use 8

K

Key to safety symbols/markings 8

M

Maintenance 35
 Mechanical seal 31
 Misuse 9

N

Noise characteristics 17

O

Oil lubrication
 Intervals 37
 Oil quality 37
 Oil quantity 38
 Operating limits 8
 Order number 6
 Other applicable documents 6

P

Partly completed machinery 6
 Permissible forces and moments at the pump
 nozzles 23
 Piping 21
 Preservation 12, 34

R

Return to supplier 12
 Returning to service 34

S

Safety 8
 Safety awareness 9
 Scope of supply 17
 Shaft seal 15
 Shutdown 34
 Spare part
 Ordering spare parts 47
 Spare parts stock 47
 Special accessories 17
 Storage 12, 34

T

Tightening torques 46
 Transport 11
 Trouble-shooting
 Causes and remedies 49

W

Warnings 8



KSB SE & Co. KGaA

Johann-Klein-Straße 9 • 67227 Frankenthal (Germany)

Tel. +49 6233 86-0

www.ksb.com