

**CARATTERISTICHE COSTRUTTIVE / CONSTRUCTION FEATURES
CARACTERÍSTICAS CONSTRUCTIVAS / CARACTÉRISTIQUES D'EXÉCUTION**

Corpo pompa	ghisa
Pump body	cast iron
Cuerpo bomba	fundición
Corps de pompe	fonte
Supporto motore	ghisa ghisa o alluminio (CM75÷100)
Motor bracket	cast iron cast iron or aluminium (CM75÷100)
Soporte motor	fundición fundición o aluminio (CM75÷100)
Support moteur	fonte fonte ou aluminium (CM75÷100)
Girante	Noryl® (CM45) Noryl® o ottone (CM50-314) Ottone (CM400-550)
Impeller	Noryl® (CM45) Noryl® or brass (CM50-314) Brass (CM400-550)
Rodete	Noryl® (CM45) Noryl® o latón (CM50-314) Latón (CM400-550)
Turbine	Noryl® (CM45) Noryl® ou laiton (CM50-314) Laiton (CM400-550)
Tenuta meccanica	ceramica-grafite
Mechanical seal	ceramic-graphite
Sello mecánico	cerámica-grafito
Garniture mécanique	céramique-graphite
Albero motore	acciaio AISI 416 (CM45÷100) acciaio AISI 303 (CM164÷550)
Motor shaft	stainless steel AISI 416 (CM45÷100) stainless steel AISI 303 (CM164÷550)
Eje motor	acero AISI 416 (CM45÷100) acero AISI 303 (CM164÷550)
Arbre moteur	acier AISI 416 (CM45÷100) acier AISI 303 (CM164÷550)
Temperatura del liquido	girante Noryl® o supporto alluminio: 0 - 50 °C girante ottone: 0 - 90 °C
Liquid temperature	Noryl® impeller or aluminium bracket: 0 - 50 °C brass impeller: 0 - 90 °C
Temperatura del líquido	rodete Noryl® o soporto alluminio: 0 - 50 °C rodete latón: 0 - 90 °C
Température du liquide	turbine Noryl® or support aluminium: 0 - 50 °C turbine laiton: 0 - 90 °C
Pressione di esercizio	
Operating pressure	max 6 bar (CM45-100)
Presión de trabajo	max 8 bar (CM164-550)
Pression de fonctionnement	
MOTORE / MOTOR / MOTOR / MOTEUR	
Motore 2 poli a induzione	3~ 230/400V-50Hz
2 pole induction motor	1~ 230V-50Hz (con termoprotettore with thermal protection)
Motor de 2 polos a inducción	with thermal protection con protección térmica
Moteur à induction à 2 pôles	avec protection thermique)
Classe di isolamento	
Insulation class	F
Clase de aislamiento	
Classe d'isolation	
Grado di protezione	
Protection degree	IP44
Grado de protección	
Protection	



Pompe centrifughe monogirante estremamente silenziosa adatta ad applicazioni domestiche civili e industriali. La curva estremamente piatta garantisce pressioni pressoché costanti al variare della portata.

Single impeller centrifugal pumps, extremely silent suitable for household, civil and industrial applications, with a very flat curve to guarantee constant pressure even when the delivery.

Bombas centrifugas con un rodete extremadamente silenciosas apropiadas en aplicaciones domésticas civiles e industriales con una curva extremadamente plana; garantizan presiones casi constantes cuando varía el caudal.

Pompes centrifuges monoroue très silencieuses, aptes aux applications domestiques, civiles et industrielles. La courbe caractéristique très plate garantit des pressions quasiment constantes en cas de variation du débit.

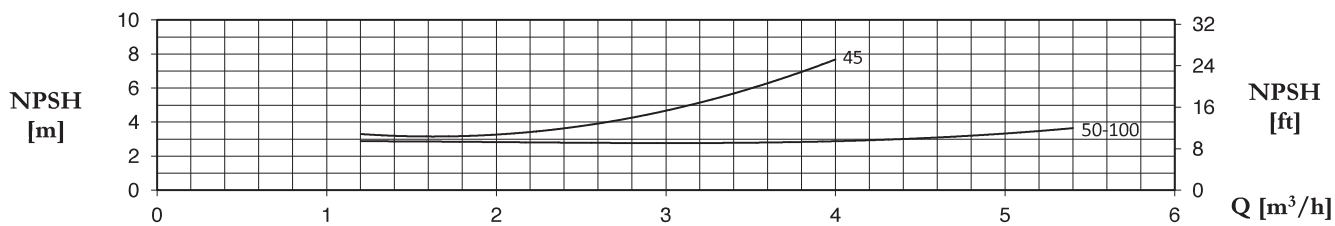
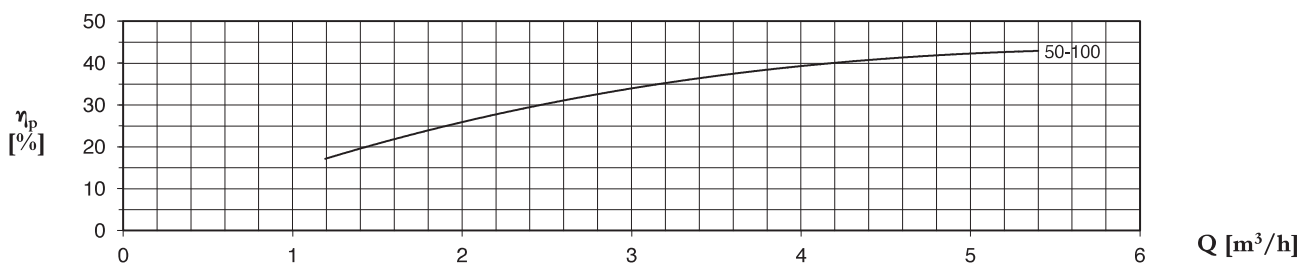
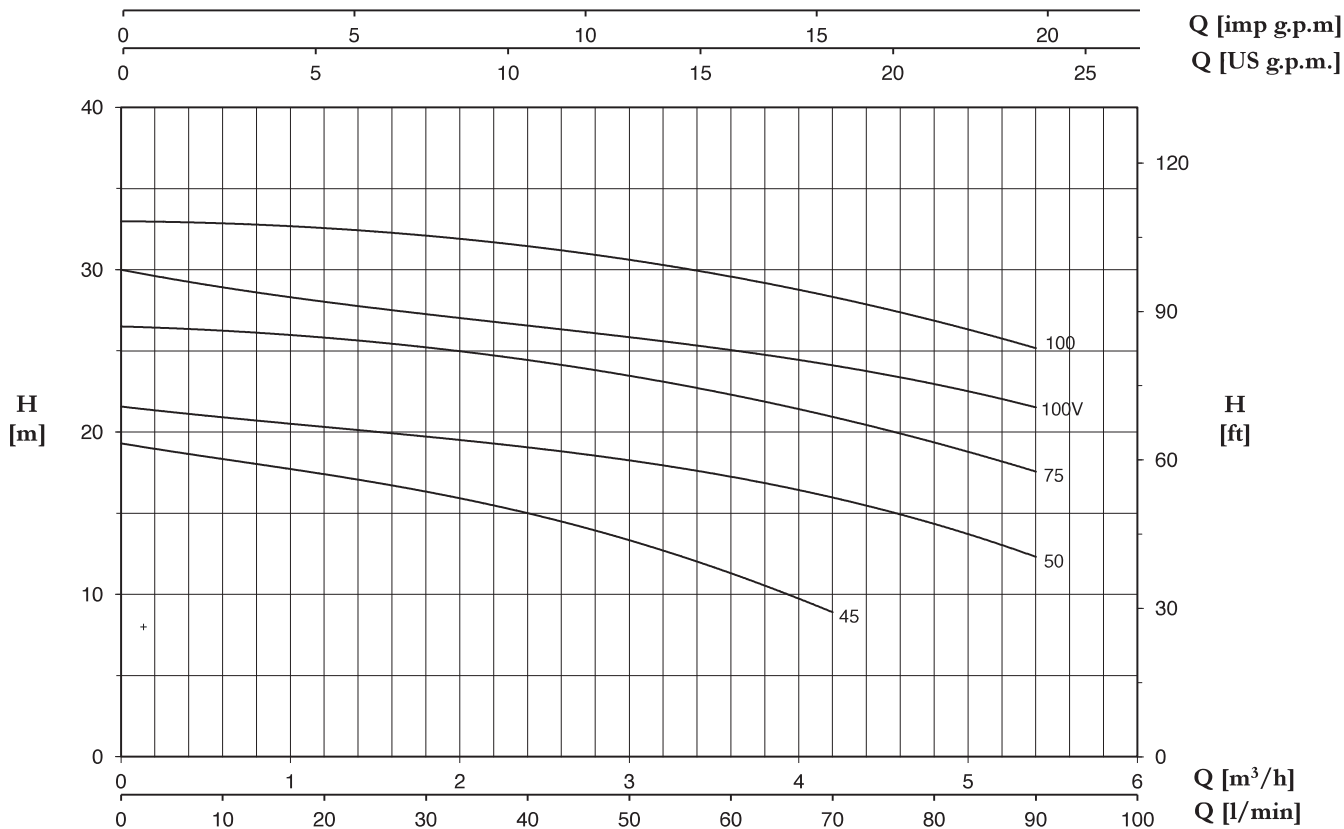

TYPE		P2		P1 (kW)		AMPERE		Q (m³/h - l/min)						
1~	3~					1~	3~	0	1,2	2,4	3,6	4,2	4,8	5,4
		(HP)	(kW)	1~	3~	1x230 V 50 Hz	3x400 V 50 Hz	H (m)						
CM 45	CMT 45	0,4	0,3	0,51	0,56	2,3	1	19,3	17,4	15	11,3	8,9	-	-
CM 50	CMT 50	0,5	0,37	0,59	0,65	2,8	1,1	21,5	20,5	19	17	15,8	15	12
CM 75	CMT 75	0,8	0,59	0,9	0,94	4,5	1,7	26,5	25,8	24,5	22,2	20,9	19,5	17,5
CM 100 V	-	1	0,74	1,05	-	4,6	-	30	28	26,6	25	24,1	23	21,5
CM 100	CMT 100	1	0,74	1,16	1,17	5,7	2	33	32,5	31,5	29,6	28,3	26,8	25,2

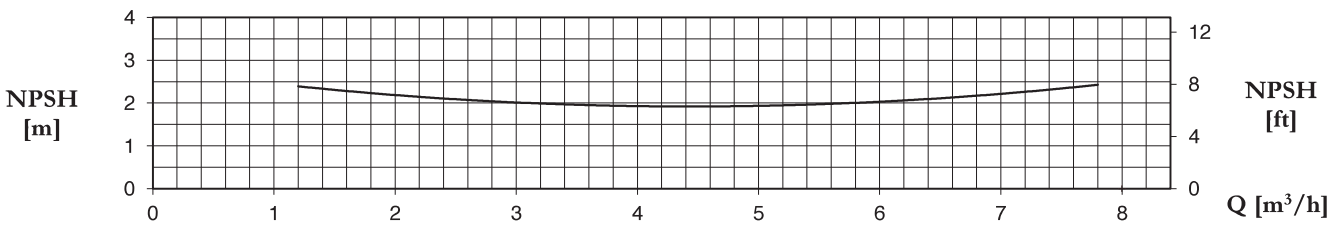
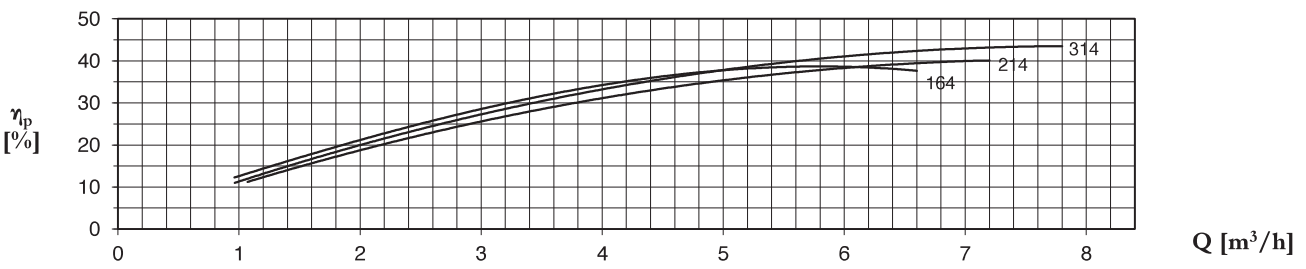
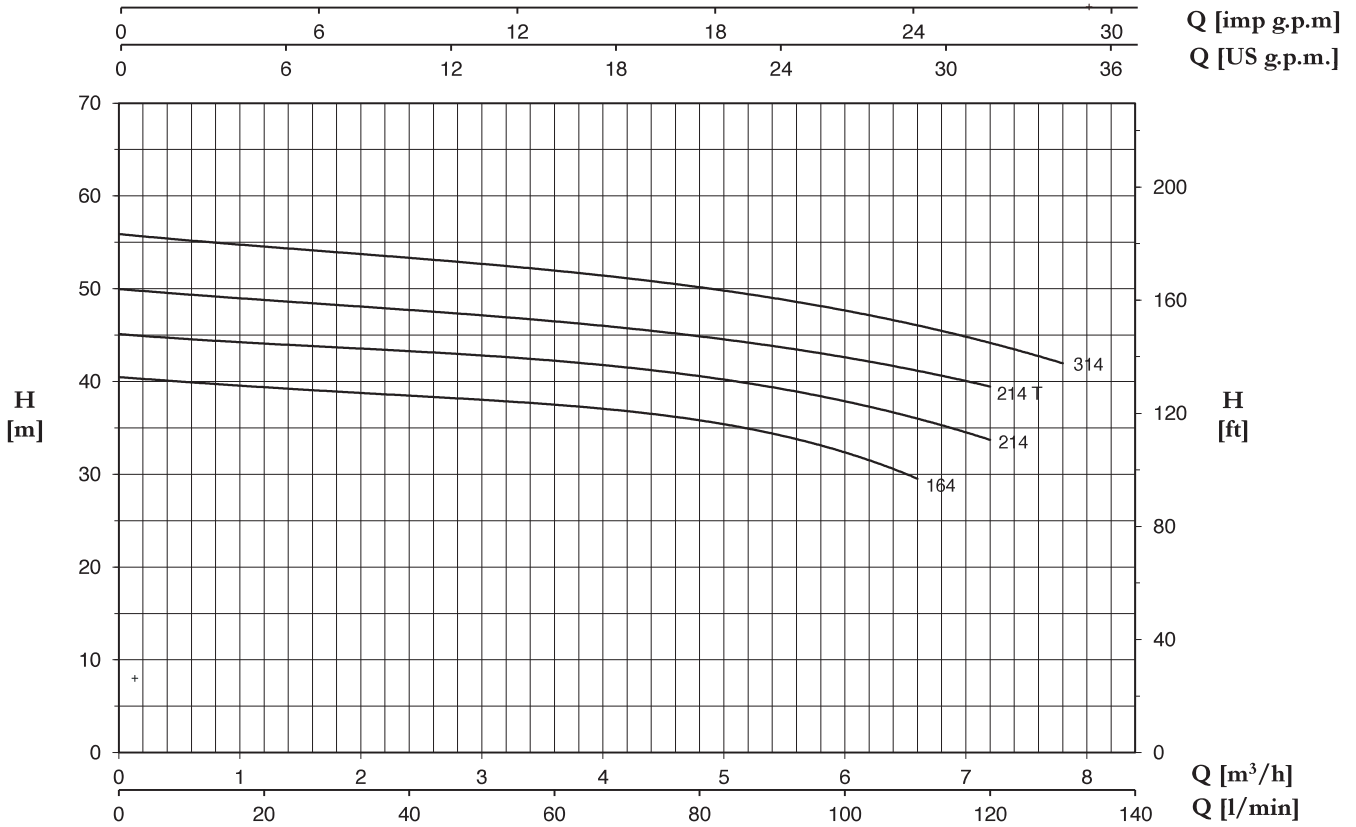

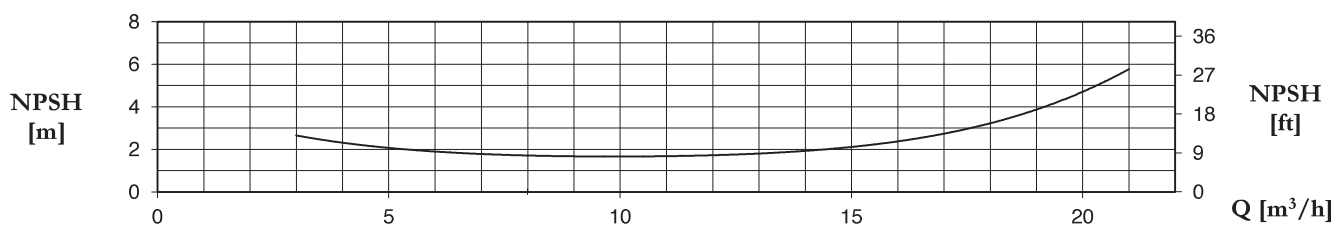
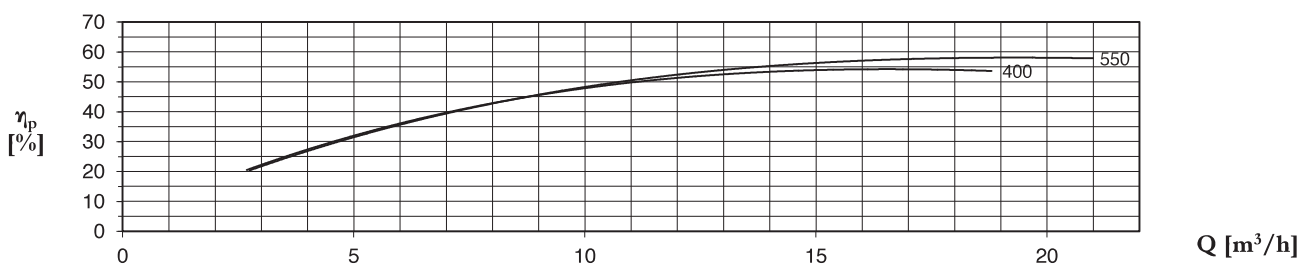
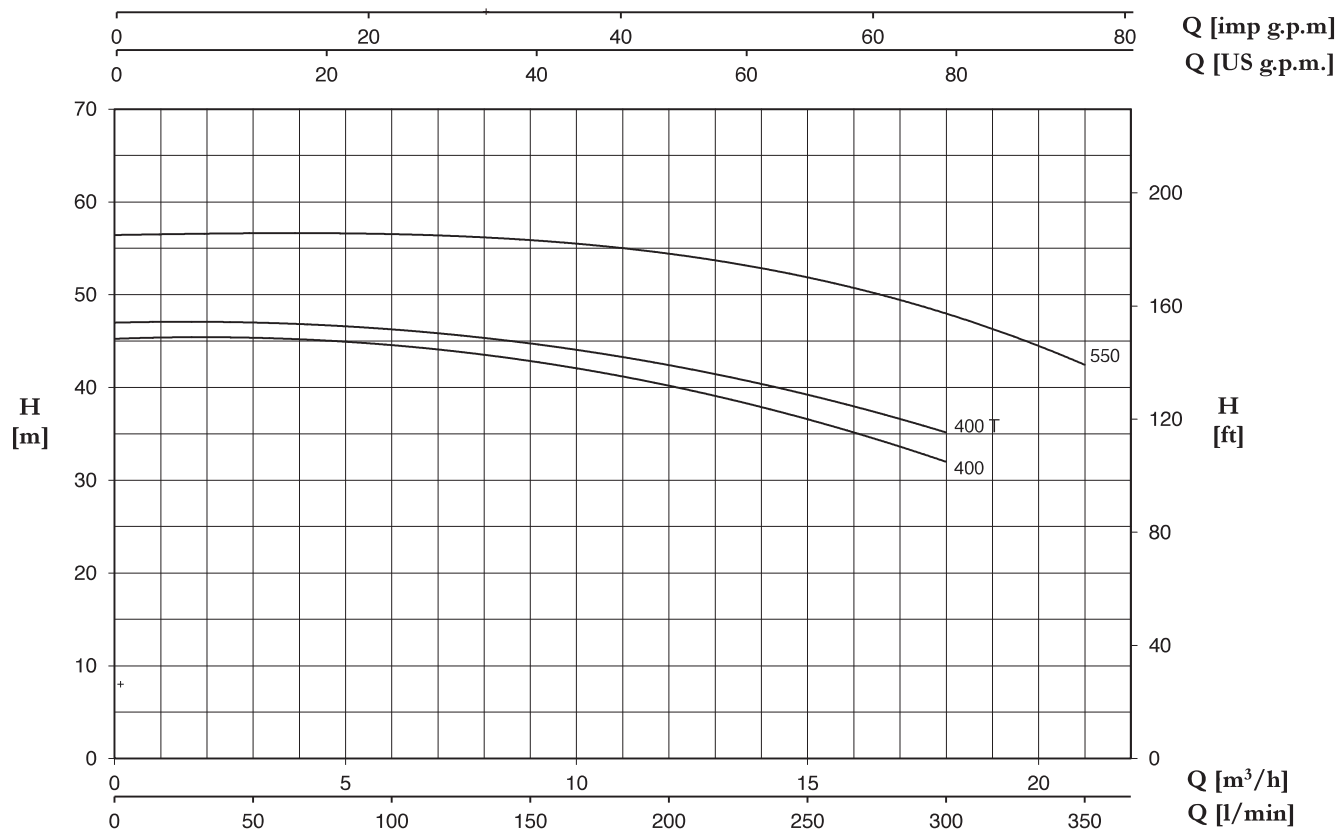

TYPE		P2		P1 (kW)		AMPERE		Q (m³/h - l/min)								
1~	3~					1~	3~	0	1,2	2,4	3,6	4,8	5,4	6,6	7,2	7,8
		(HP)	(kW)	1~	3~	1x230 V 50 Hz	3x400 V 50 Hz	0	20	40	60	80	90	110	120	130
CM 164	CMT 164	1,5	1,1	1,9	1,8	8,5	3,4	40,5	39,3	38,6	37,5	35,6	34,6	29,5	-	-
CM 214	-	2	1,5	2,2	-	10,3	-	45,1	44,1	43,3	42,3	40,5	39,2	36,4	33,5	-
-	CMT 214	2	1,5	-	2,43	-	4,9	50	48,7	47,8	46,5	44,9	43,7	41,3	39,4	-
CM 314	CMT 314	3	2,2	2,85	2,67	13,5	5,1	55,9	54,5	53,4	52	50,1	48,9	46,2	44,2	41,9

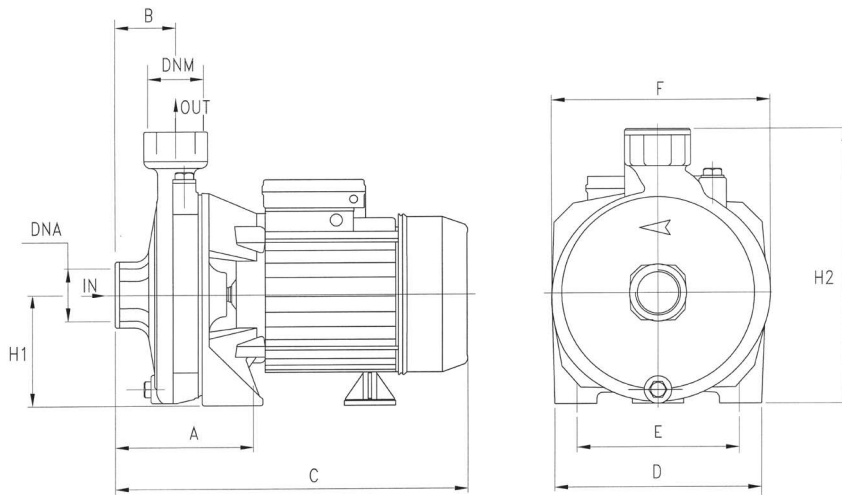

TYPE		P2		P1 (kW)		AMPERE		Q (m³/h - l/min)							
1~	3~	(HP)	(kW)	1~	3~	1~	3~	0	3	6	9	12	15	18	21
								0	50	100	150	200	250	300	350
								H (m)							
						1x230 V 50 Hz	3x400 V 50 Hz								
CM 400	-	4	3,0	4,0	-	17,8	-	45,3	45,2	44,7	42,9	40,1	36,6	32	-
-	CMT 400	4	3,0	-	3,8	-	6,6	47	47	46,2	44,8	42,5	39,1	35,2	-
-	CMT 550	5,5	4,0	-	5,4	-	9,4	56,5	56,5	56,5	56	54,5	51,8	47,9	42,5



TYPE	DIMENSIONS (mm)													
	A	B	C	D	E	F	H1	H2	DNA	DNM	I	L	M	
CM 45	95	45,5	265	150	110	160	82	202	1" G	1" G	290	175	225	8,5
CM 50	95	45,5	265	150	110	160	82	202	1" G	1" G	290	170	230	9
CM 75	110	46,5	300	180	140	185	97	234	1" G	1" G	325	200	265	12,7
CM 100 V	110	46,5	300	180	140	185	97	234	1" G	1" G	325	200	265	13,5
CM 100	110	46,5	300	180	140	185	97	234	1" G	1" G	325	200	265	14
CM 164	117	46,5	348	220	180	225	115	285	1" 1/4 G	1" G	370	240	315	22,5
CM 214	117	46,5	348	220	180	225	115	285	1" 1/4 G	1" G	370	240	315	23
CM 314	117	46,5	M 410	220	180	225	115	285	1" 1/4 G	1" G	370	240	315	M 27,5
			T 348											T 23,5
CM 400	108	54	425	240	190	250	133	323	2" G	1" 1/4 G	440	270	360	39,8
CM 550	108	54	425	240	190	250	133	323	2" G	1" 1/4 G	440	270	360	39,8

TYPE				
	TRUCK		CONTAINER	
	PALLET (cm)	N° pumps	PALLET (cm)	N° pumps
CM 45-50	80x120x145	102	80x120x190	136
CM 75-100	85x110x145	65	85x110x195	91
CM 164-314	85x110x140	40	85x110x170	60
CM 314 M	85x110x150	24	85x110x180	30
CM 400-550	85x110x150	24	85x110x180	30