

NM, NMS

Close Coupled Centrifugal Pumps with flanged connections



Construction

Close-coupled centrifugal pumps; electric motor with extended shaft directly connected to the pump up to 22 kW, new bracket construction for standard motors (stub-shaft construction) from 30 to 75 kW with integrated thrust bearing.

Pump casing with axial suction and radial delivery on top, main dimensions and performance according to EN 733.

NM(S): version with pump casing and lantern bracket in cast iron. B-NM(S): version with pump casing and lantern bracket/casing cover in bronze. (the pumps are supplied fully painted).

Connections: Flanges according to PN 10, EN 1092-2.

Counter-flanges (on request)

Sizes	Flanges
from NM 32/.. to NM 50/...	Screwed flanges EN 1092-1, PN 16
from NM 65/.. to NMS 100/...	Flanges for welding EN 1092-1, PN 10

Version with frequency converter (on request)

Applications

For clean liquids without abrasives, which are non-aggressive for the pump materials (solids content up to 0,2%). For water supply. For heating, air conditioning, cooling and circulation plants.

For civil and industrial applications. For fire fighting applications. For irrigation.

Operating conditions

Liquid temperature from -10 °C to +90 °C.

Ambient temperature up to 40° C.

Total suction lift up to 7 m.

Maximum permissible working pressure up to 10 bar (16 bar for NM 32L/16,20; NM 40/16,20; NM 50/12,16; NM 65/12,16,20,25; NM 80/16; NM 100/20).

Continuous duty.

Motor

2-pole induction motor, 50 Hz (n ≈ 2900 rpm).

NM, NMS: three-phase 230/400 V ± 10% up to 3 kW; 400/690 V ± 10% from 4 to 75 kW.

Insulation class F. Protection IP 54 (IP 55 for NMS).

Motor suitable for operation with frequency converter from 1,1 kW.

Classification scheme IE3 for three-phase motors from 0,75 kW.

Constructed in accordance with: EN 60034-1; EN 60034-30-1.

Special features on request

- Other voltages. - Frequency 60 Hz (as per 60 Hz data sheet).
- Protection IP 55.- Special mechanical seal.
- Packed gland (only for NM standard construction).
- Single-phase motor (NMM) up to 1,5 kW.
- Higher or lower liquid or ambient temperatures.
- Motor suitable for operation with frequency converter up to 0,75 kW.

The electropumps NM, B-NM, NMS, B-NMS series comply with the European Regulation no. 547/2012.

Materials

Components	NM, NMS	B-NM, B-NMS
Pump casing	Cast iron	Bronze
Lantern bracket NM	GJL 200 EN 1561	G-Cu Sn 10 EN 1982
Casing cover for NMS		
Lantern bracket NMS	Cast iron GJL 200 EN 1561	
Impeller	Cast iron	Bronze
	GJL 200 EN 1561	G-Cu Sn 10 EN 1982
	Brass P- Cu Zn 40 Pb 2 UNI 5705 for 32/12, 32/16, 32/20, 32L/20, 40/20	
Shaft	Cr-Ni steel AISI 303	Cr Ni Mo steel
	AISI 430 from 3 kW to 22 kW	AISI 316
Mechanical seal	Carbon - Ceramic - NBR	
Counter-flanges	Steel Fe 430B UNI 7070	

Coverage chart n ≈ 2900 rpm

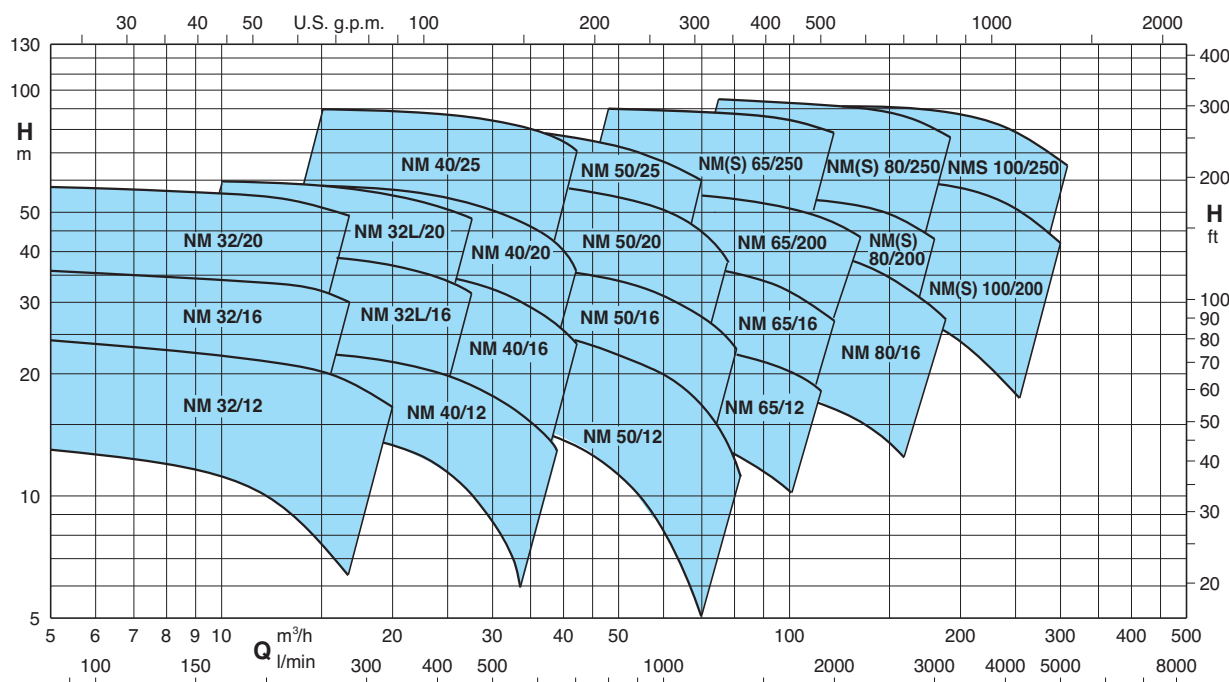

Pumps with frequency converter

The **NM EI** pumps are available with power from 0,55 kW up to 22 kW, the pumps are equipped with **I-MAT** installed on board which allows to realize a variable-speed system extremely compact and efficient, ideal in applications of water supply and in the distribution of hot and cold water.

The pump is equipped with transducers suitable for operation and is already programmed at the factory.

Advantages

- Energy saving
- Compact design
- Easy to use
- Programmable to suit the system requirements
- Reliability

Costruction

The system comprises of:

- Pump
- Induction motor
- I-MAT Frequency converter
- Motor adapter for the motor mounting of the frequency converter
- Connection cable between frequency converter and induction motor
- Transducers

Main features

- Rated motor power output from 0,55 kW to 22 kW
- Control range from 1750 to 2900 rpm (2-pole)
- Protection against dry running
- Protection against operations with closed valve ports
- Protection against system leakages
- Protection against overcurrent in the motor
- Protection against overvoltage and undervoltage of the power supply
- Protection against current unbalances between phases



Operating modes



Constant pressure mode with pressure transducer

In this mode, the system maintains the preset pressure when the flow required by the installation changes.

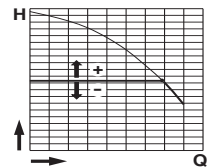

Proportional pressure mode with pressure transducer

In this mode the system changes the working pressure according to the required flow rate.

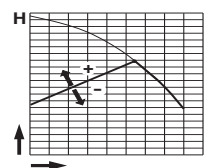

Constant flow mode with flow meter

In this mode the system maintains a constant flow rate value in a point of the installation according to the required pressure.

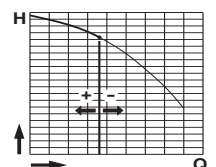

Fixed speed mode with setting of the speed preferential rotation.

In this mode, by changing the working frequency, you may choose any operational curve included within the working range.

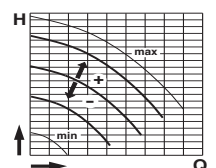

Constant temperature mode with temperature transducer

In this mode the system keeps the temperature constant inside a system by changing the speed of the pump.

Performance n ≈ 2900 rpm

B-NM	NM	P ₂		Q m³/h l/min	6,6	7,5	8,4	9,6	10,8	12	13,2	15	16,8	18,9	21	24	27	30
		kW	HP		110	125	140	160	180	200	220	250	280	315	350	400	450	500
					H m													
B-NM 32/12F	NM 32/12FE	0,55	0,75		12,5	12,5	12	11,5	11	10	9	7,5						
B-NM 32/12D	NM 32/12DE	0,75	1		18	18	17,5	17	16,5	16	15,5	14						
B-NM 32/12A/A	NM 32/12A/A	1,1	1,5		23	23	22,5	22	21,5	21	20,5	19						
B-NM 32/12S/A	NM 32/12S/A	1,5	2		23,5	23,5	23	22,5	22	21,5	21	20,5		18,5	16,5	13		
B-NM 32/16B/A	NM 32/16B/A	1,5	2		29,5	29,5	29	28,5	27,5	27	26	25*	22,5*					
B-NM 32/16A/B	NM 32/16A/B	2,2	3		35,5	35,5	35	34,5	34	33,5	33	32*	30*					
B-NM 32/20D/B	NM 32/20D/B	2,2	3		38	37,5	37	36	35	33,5	32							
B-NM 32/20C/A	NM 32/20C/A	3	4		45	44,5	44	43,5	42,5	41	40	38	36					
B-NM 32/20A/B	NM 32/20A/B	4	5,5		57,5	57	56	55,5	55	54,5	53,5	51,5	49					

B-NM	NM	P ₂		Q m³/h l/min	9,6	10,8	12	13,2	15	16,8	18,9	21	24	27	29	32	37,8	39
		kW	HP		160	180	200	220	250	280	315	350	400	450	483	533	630	650
					H m													
B-NM 32L/16C	NM 32L/16C	2,2	3		25,1	24,9	24,7	24,4	23,8	23	21,8	20,3	17,3	13,4				
B-NM 32L/16B	NM 32L/16B	3	4		30,4	30,3	30,2	30	29,6	29	28,1	26,8	24,2	20,8	17,9			
B-NM 32L/16A	NM 32L/16A	4	5,5		39,9	39,9	39,8	39,6	39,3	38,8	37,9	36,8	34,7	31,9	29,7	25,6		
B-NM 32L/20C	NM 32L/20C	4	5,5		42,1	41,8	41,5	41	40,2	38,9	37	34,5	29,7	23,8				
B-NM 32L/20B	NM 32L/20B	5,5	7,5		51,7	51,6	51,4	51,2	50,7	50	48,8	47	43,2	37,8	33,5			
B-NM 32L/20A	NM 32L/20A	7,5	10		59,4	59,4	59,4	59,4	59,2	58,8	58	56,6	53,4	48,6	44,6	37,7		

B-NM	NM	P ₂		Q m³/h l/min	15	16,8	18,9	21	24	27	30	33	37,8	39	42	45	48	54
		kW	HP		250	280	315	350	400	450	500	550	630	650	700	750	800	900
					H m													
B-NM 40/12F/A	NM 40/12F/B	1,1	1,5		14	13,5	13	12	11	9,5	8	6						
B-NM 40/12C/A	NM 40/12C/B	1,5	2		17,5	17	16,5	16	15	13,5	12	10,5	7,5	6,5				
B-NM 40/12A/B	NM 40/12A/C	2,2	3		22	22	21,5	21	20	19	18	16,5	14	13	11,5			
B-NM 40/16C/B	NM 40/16C/C	2,2	3		23	22,5	22	21,5	20	18,5	16,5	14,5	11	10				
B-NM 40/16B/A	NM 40/16B/B	3	4		29	28,8	28	27,5	26,5	25	23,5	21,5	18	17	14			
B-NM 40/16A/B	NM 40/16A/C	4	5,5		37	36,5	36,5	36	35	33,5	32	30,5	27	26	23,5	20	17	
B-NM 40/20D/B	NM 40/20D/B	4	5,5		39	38	37	35,5	33,5	30,5	27	22,5	14					
B-NM 40/20C/B	NM 40/20C/B	4	5,5		41,5	40,5	39,5	38	36	33,5								
B-NM 40/20B/A	NM 40/20B/A	5,5	7,5		50	49,5	48,5	47,5	45,5	43,5	41,5	37,5	30,5					
B-NM 40/20AR/A	NM 40/20AR/A	5,5	7,5		55	54,5	54	53	51	49								
B-NM 40/20A/A	NM 40/20A/A	7,5	10		57,5	57	56,5	55,5	54,5	52,5	50,5	48	42,5	40,5	35			
B-NM 4025/C/C	NM 40/25C/C	9,2	12,5		61	61	60,5	59,5	58,5	56,5	53,5	49,5	41,5	40	33,5			
B-NM 4025/B/C	NM 40/25B/C	11	15		69,5	69,5	69	68,5	67	65,5	63,5	60,5	53,5	51	45			
B-NM 4025/A/C	NM 40/25A/C	15	20		90	90	89,5	89	88,5	87	85	83	77,5	76	70,5			

B-NM	NM	P ₂		Q m³/h l/min	24	27	30	33	37,8	42	48	54	60	66	69	72	75	78	81	84
		kW	HP		400	450	500	550	630	700	800	900	1000	1100	1150	1200	1250	1300	1350	1400
					H m															
B-NM 50/12F/B	NM 50/12F/C	2,2	3				15,5	15	14	13,5	12	10	8	6						
B-NM 50/12D/A	NM 50/12D/B	3	4				20	19,5	18,5	18	16,5	14,5	13	10,5	9	8				
B-NM 50/12A/B	NM 50/12A/C	4	5,5				24	24	23	22,5	21	19,5	17,5	15	14	12,5	11,5	10		
B-NM 50/12S/B	NM 50/12S/C	4	5,5				26,5	26	25,5	24,5	23,5	22	20	18	16,5	15,5	14	13	11	
B-NM 50/16B/B	NM 50/16B/B	5,5	7,5				31	30,5	29,5	28	26	24	21,5	19	17,5	15,5	13,5	11,5	9,5	
B-NM 50/16A/B	NM 50/16A/B	7,5	10				38,5	38	37,5	36,5	34,5	32,5	30	27	25,5	24	22,5	20,5	19	
B-NM 50/20B/C	NM 50/20B/C	9,2	12,5		48	47,5	47,5	47	45,5	44,5	42,5	40	37	33	30,5	28	25,5	23		
B-NM 50/20A/C	NM 50/20A/C	11	15		55	55	54,5	54,5	53,5	52	50	48	45	41,5	39,5	37	35	32,5		
B-NM 50/20S/C	NM 50/20S/C	15	20		60	60	59,5	59,5	58,5	57,5	55,5	53,5	50,5	47	45	43	40,5	37		
B-NM 5025/C/C	NM 50/25C/C	11	15		55	54,5	54	53	51,5	49,5	46	41,5	35,5	28,5	24,5					
B-NM 5025/B/C	NM 50/25B/C	15	20		69	68,5	68	67,5	66	64	61	57	52,5	46,5	43					
B-NM 50/25A	NM 50/25A/D	18,5	25		80,5	80,5	80	79,5	78,5	77	74,5	71,5	67	61,5	58,5					

Performance n ≈ 2900 rpm

B-NM - B-NMS	NM - NMS	P ₂		Q m³/h l/min	37,8	42	48	54	60	66	75	84	96	108	120	132	141	150
		kW	HP		630	700	800	900	1000	1100	1250	1400	1600	1800	2000	2200	2350	2500
					H m													
B-NM 65/12E/A	NM 65/12E/C	4	5,5	16,5	16,4	16,2	15,9	15,5	15,1	14,3	13,2	11,4	9,2					
B-NM 65/125C/B	NM 65/12C/B	5,5	7,5	21,1	21	20,8	20,6	20,3	19,9	19,1	18,2	16,5	14,4	11,8				
B-NM 65/125A/B	NM 65/12A/B	7,5	10	25,9	25,8	25,6	25,4	25,1	24,8	24,1	23,3	21,9	20	17,6				
B-NM 65/160D/B	NM 65/16D/B	7,5	10			24,3	24,1	23,9	23,6	23,1	22,3	20,8	18,8	16,3				
B-NM 65/160C/C	NM 65/16C/C	9,2	12,5			28,1	28,0	27,8	27,6	27,1	26,3	24,9	23,1	20,7	17,7			
B-NM 65/160B/C	NM 65/16B/C	11	15			32,6	32,5	32,3	32	31,5	30,8	29,5	27,9	25,7	23,0			
B-NM 65/160AR	NM 65/16AR	15	20			36,4	36,3	36,2	35,9	35,5	34,8	33,7	32,1	30,0	27,5			
B-NM 65/160A/C	NM 65/16A/C	15	20			40,5	40,4	40,2	40	39,5	38,8	37,6	36,1	34,2	31,7			
B-NM 65/200C/C	NM 65/20C/C	15	20			44	43,8	43,5	43,1	42,3	41,2	39,4	37,1	34,4	31,4	28,8		
B-NMS 65/200B	NM 65/20B/D	18,5	25			50,5	50,4	50,2	49,9	49,2	48,3	46,8	44,8	42,5	39,8	37,5		
B-NMS 65/200A	NM 65/20A/A	22	30			57	57	57	56,5	56	55,5	54	52,5	50	47,5	45,5		
B-NM 65/250C/B	NM 65/25C/A	22	30			61	61	60,5	60	58,5	57	54,5	51,5	47,5	43			
B-NMS 65/250B/A	NMS 65/250B/A	30	40			73,5	73,5	73,5	73,5	73	71,5	69,5	66,5	63	59			
B-NMS 65/250A/B	NMS 65/250A/B	37	50			86,5	86,5	87	86,5	86	85,5	83,5	81	78	74,5			

B-NM - B-NMS	NM - NMS	P ₂		Q m³/h l/min	75	84	96	108	120	132	150	168	180	192	210	240	270	300
		kW	HP		1250	1400	1600	1800	2000	2200	2500	2800	3000	3200	3500	4000	4500	5000
					H m													
B-NM 80/160E/B	NM 80/16E/B	7,5	10	21,5	20,9	19,9	18,7	17,4	15,9	13,4	10,6							
B-NM 80/160D/C	NM 80/16D/C	9,2	12,5	25,2	24,5	23,5	22,4	21,1	19,6	17,2	14,4							
B-NM 80/160C/C	NM 80/16C/C	11	15	28,7	28,2	27,4	26,4	25,1	23,8	21,3	18,5	16,4						
B-NM 80/160B/C	NM 80/16B/C	15	20	34,8	34,5	33,8	33	32,1	30,9	28,9	26,4	24,5	22,4					
B-NM 80/16A	NM 80/16A/D	18,5	25	39,9	39,6	39	38,2	37,4	36,4	34,5	32,2	30,3	28,1					
B-NMS 80/200B/A	NM 80/20B	22	30	46,5	46	45,5	44,5	43,5	42	39*	35,5*	32*						
B-NMS 80/200A/A	NMS 80/200A	30	40	56	55,5	55	54	53	52	49,5*	46*	43*						
B-NMS 80/250E/A	NM 80/25E	22	30	51	50	48,5	46,5	44,5	42	38*	33*	29*						
B-NMS 80/250D/A	NMS 80/250D	30	40	65	64	62,5	61	59	56,5	53*	49*	45,5*	41*					
B-NMS 80/250C/A	NMS 80/250C/A	37	50	73,5	73	72	70,5	69	67	63*	59*	55,5*	51,5*					
B-NMS 80/250B/A	NMS 80/250B/A	45	60	84	83,5	82,5	81,5	80	78	74,5*	70,5*	67*	63*					
B-NMS 80/250A/A	NMS 80/250A/A	55	75	95	94,5	93,5	92,5	91,5	90	87,5*	84*	80,5*	76,5*					
B-NMS 100/200E/B	NM 100/20E/A	18,5	25				30	29,5	29	28	27	26	25	23	19*			
B-NMS 100/200D/A	NM 100/20D	22	30				36	35,5	35	34	33	32	31	29	24,5*	19*		
B-NMS 100/200C/A	NMS 100/200C	30	40				45	44,5	44	43,5	42,5	41,5	40,5	39	34,5*	29*	22°	
B-NMS 100/200B/A	NMS 100/200B/A	37	50				54	53,5	53	52,5	51,5	50,5	49,5	48	44*	38,5*	32°	
B-NMS 100/200A/A	NMS 100/200A/A	45	60				61,5	61	60,5	60	59,5	58,5	58	56,5	53*	48*	42°	
B-NMS 100/250B/A	NMS 100/250B/A	55	75				73,5	73	72,5	71,5	70	68,5	67	65	61*	55,5*	48,5°	
B-NMS 100/250A/A	NMS 100/250A/A	75	100				91	90,5	90	89,5	88,5	88	87	85	81*	75*	67°	

NM(S) Standard construction.
B-NM(S) Bronze construction.

P₂ Rated motor power output.
H Total head in m.

* Maximum suction lift 1-2 m.
◦ With 1 m suction head.
Tolerances according to UNI EN ISO 9906:2012

Rated currents

P ₂		230V Δ / 400V Y			IA/IN
kW	HP	IN A	IN A	IN A	
0,55	0,75	4	2,3	4,8	
0,75	1	4	2,3	6,1	
1,1	1,5	4,6	2,7	5,5	
1,5	2	7,5	4,3	6,1	
2,2	3	9,2	5,3	8,4	
3	4	11,5	6,6	8,2	
4	5,5		9,6	5,5	8,9
5,5	7,5		10,8	6,2	9,1
7,5	10		14,3	8,3	9,1
9,2	12,5		18,5	10,7	8,2
11	15		21,5	12,4	8,5
15	20		27,3	15,8	9,5
18,5	25		34	19,6	9,5
22	30		41	23,7	9,5
30	40		53	30,5	8,6
37	50		65	37,5	7,1
45	60		78	45	6,9
55	75		95	55	6,7
75	100		128	74	6,8

P₂ Rated motor power output.
IA/IN D.O.L. starting current / Nominal current

Characteristic curves $n \approx 2900$ rpm

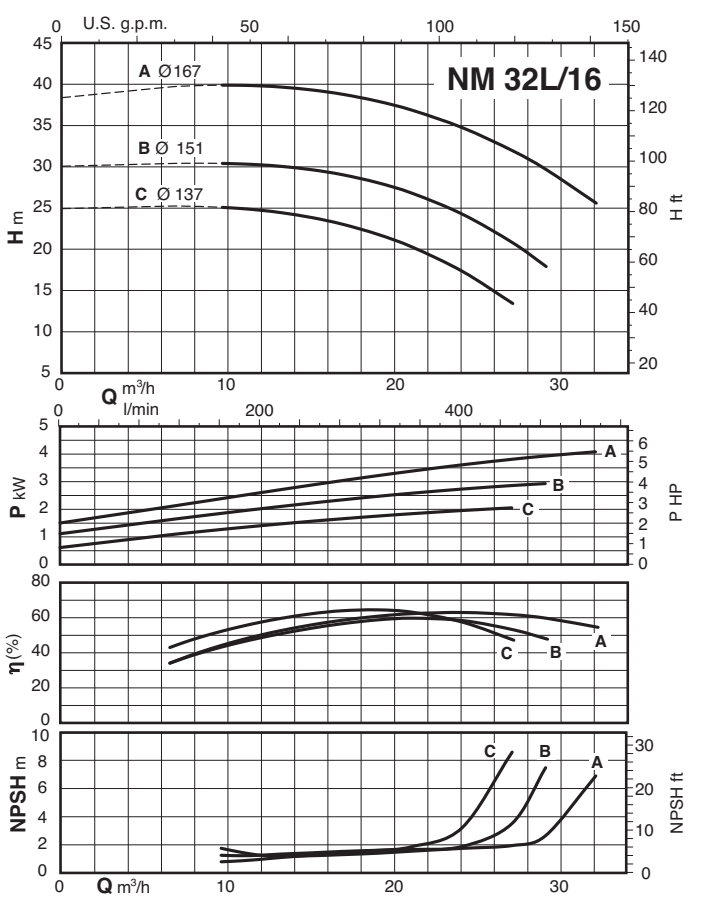
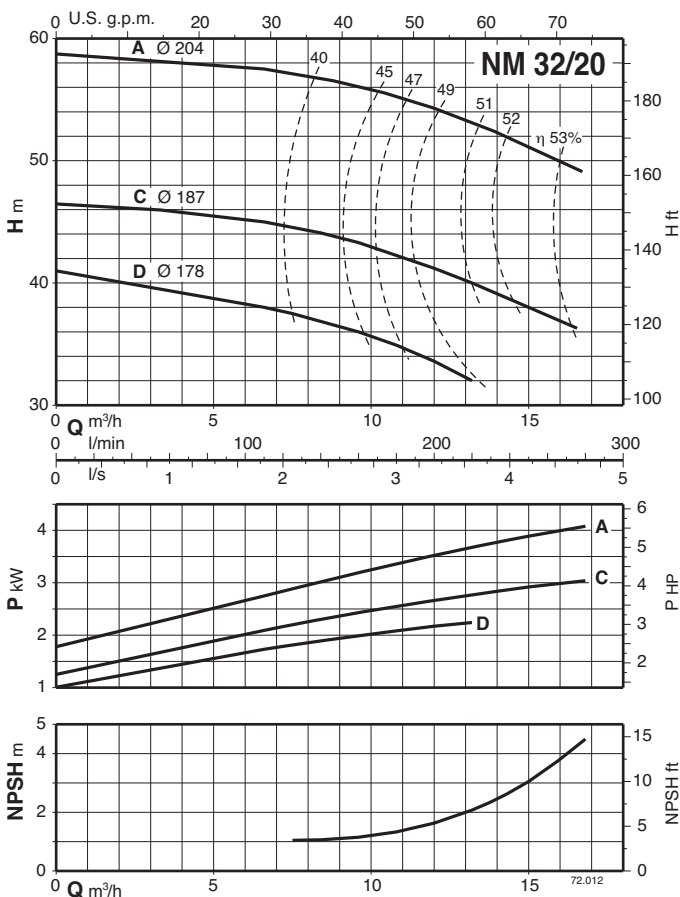
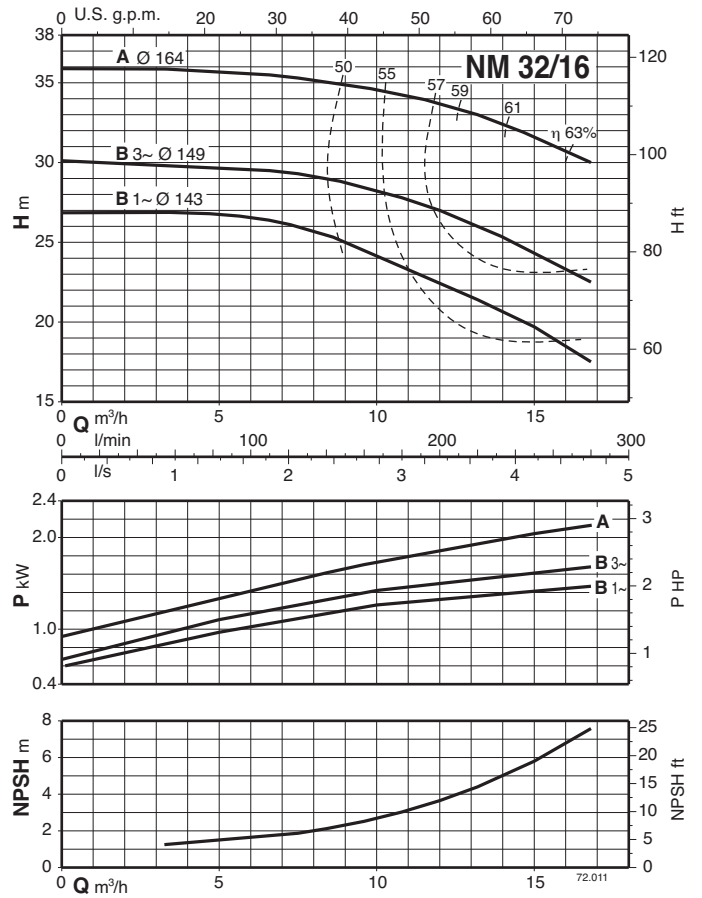
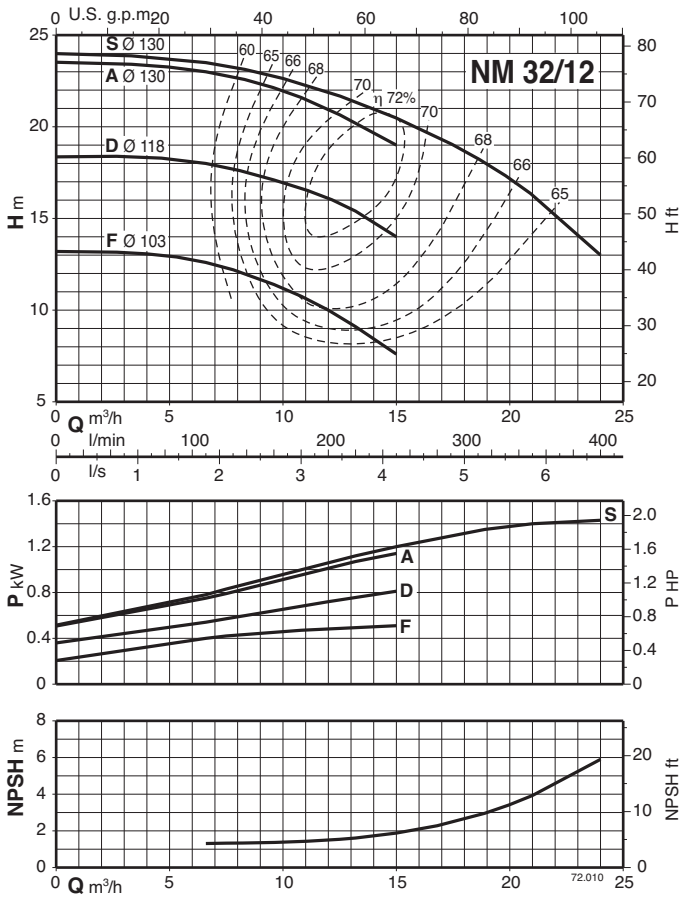

Characteristic curves $n \approx 2900$ rpm

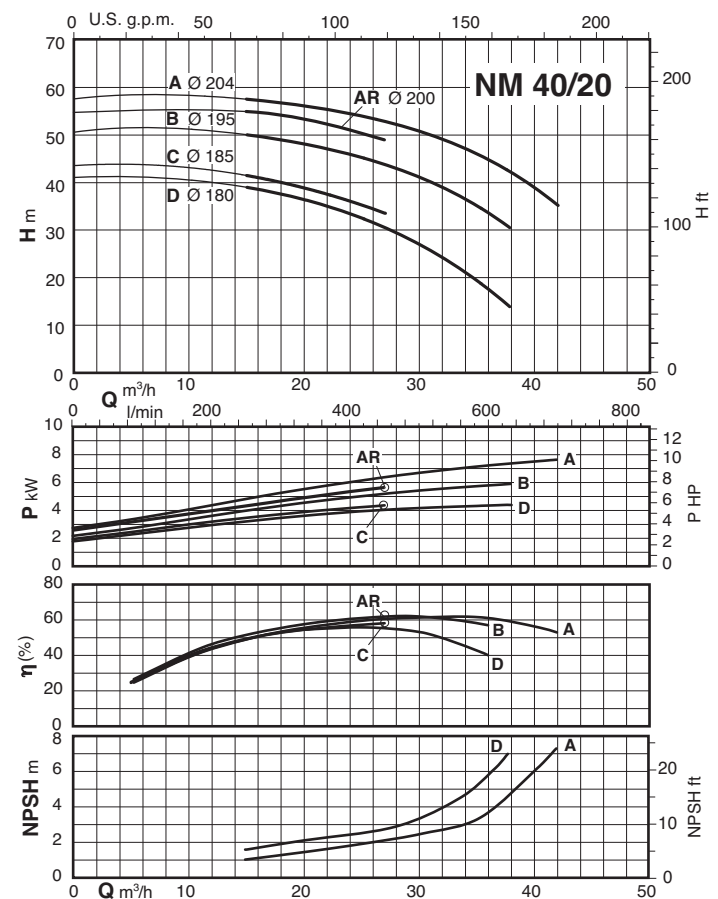
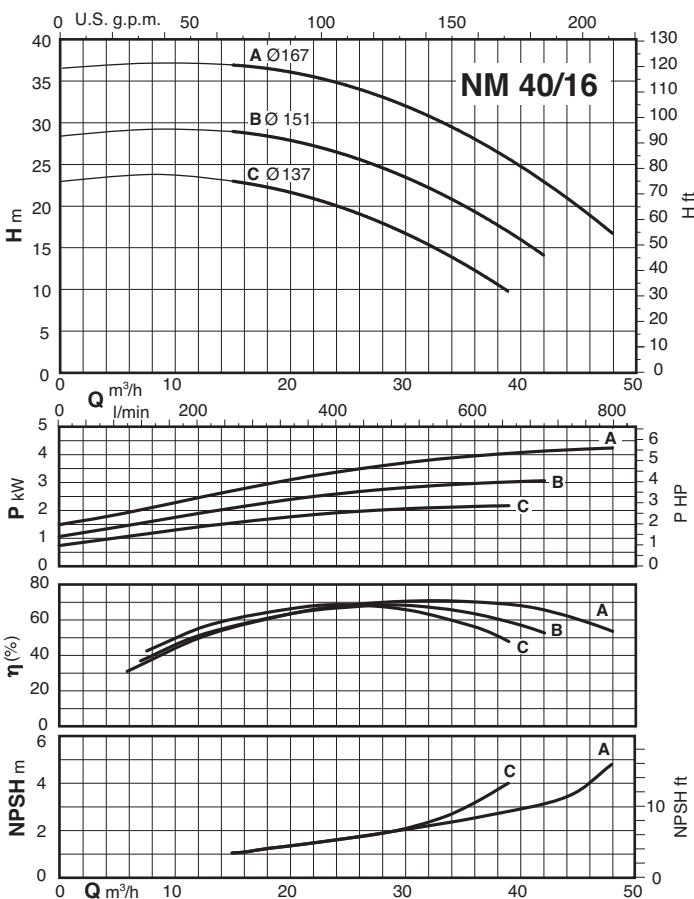
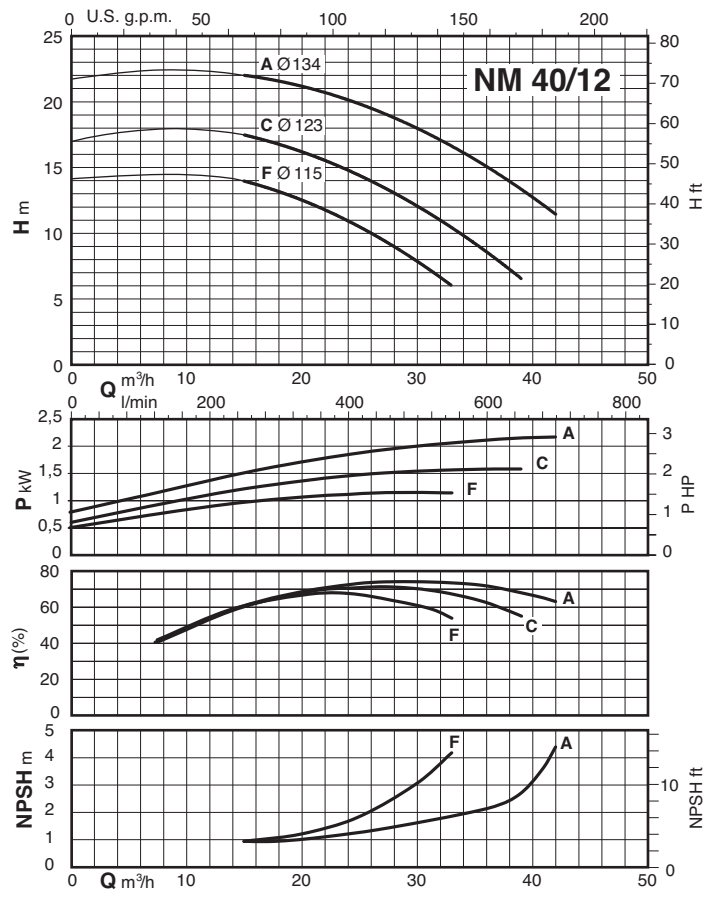
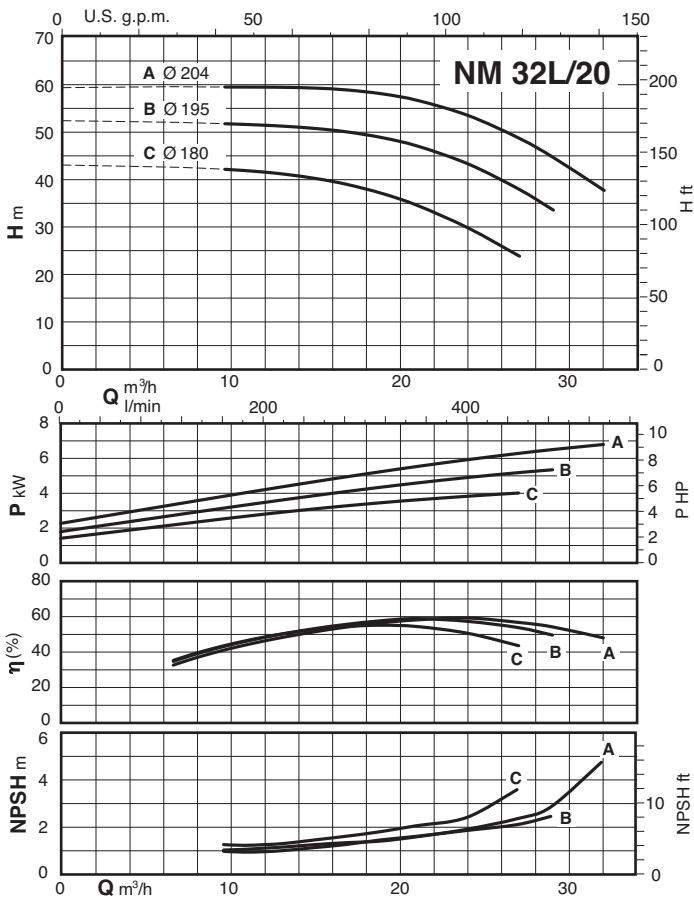

Characteristic curves $n \approx 2900$ rpm

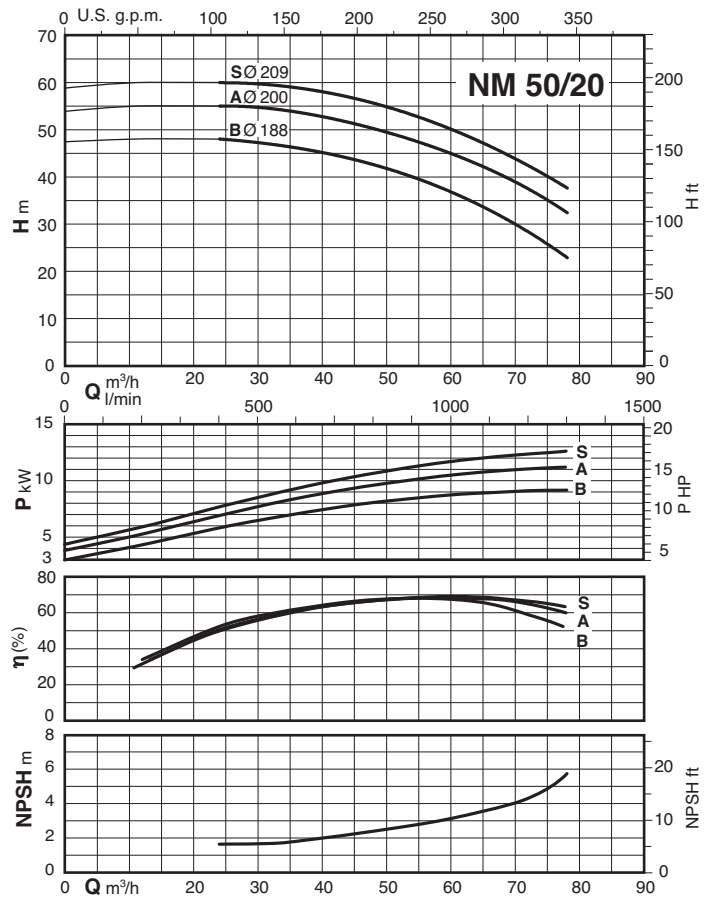
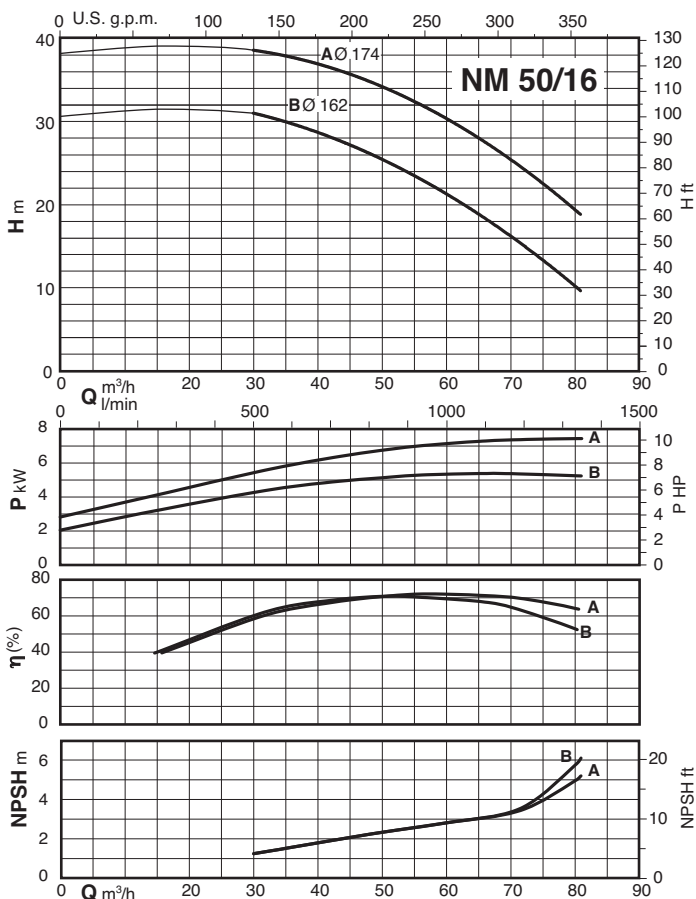
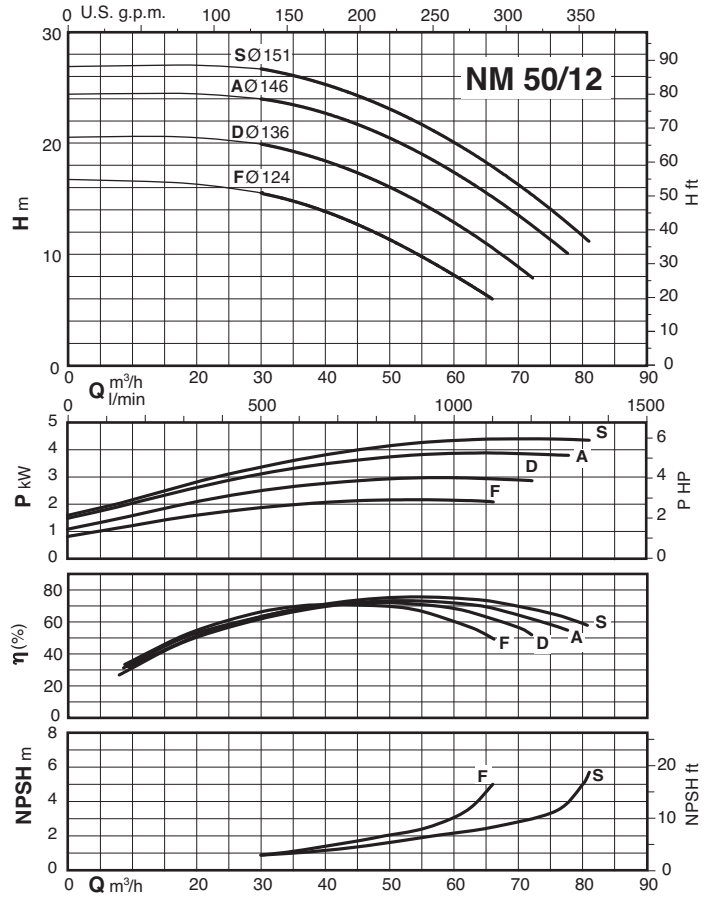
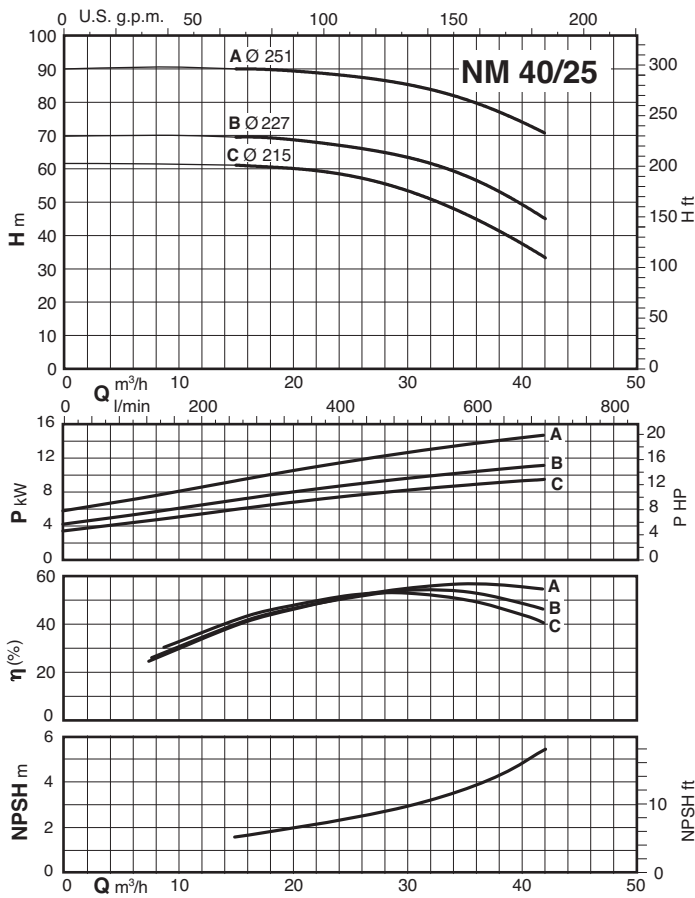

Characteristic curves $n \approx 2900$ rpm

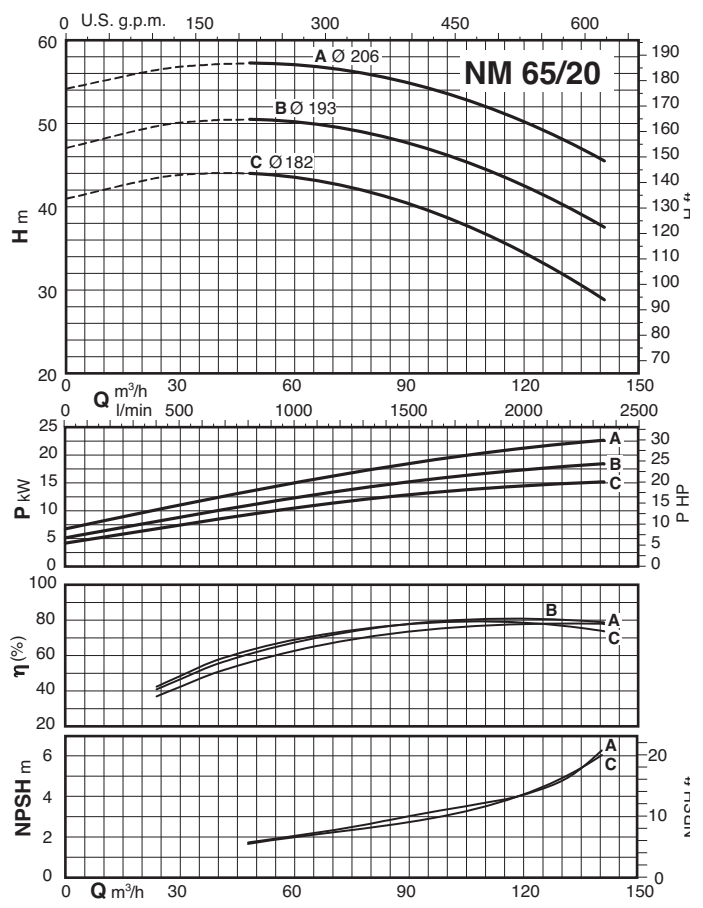
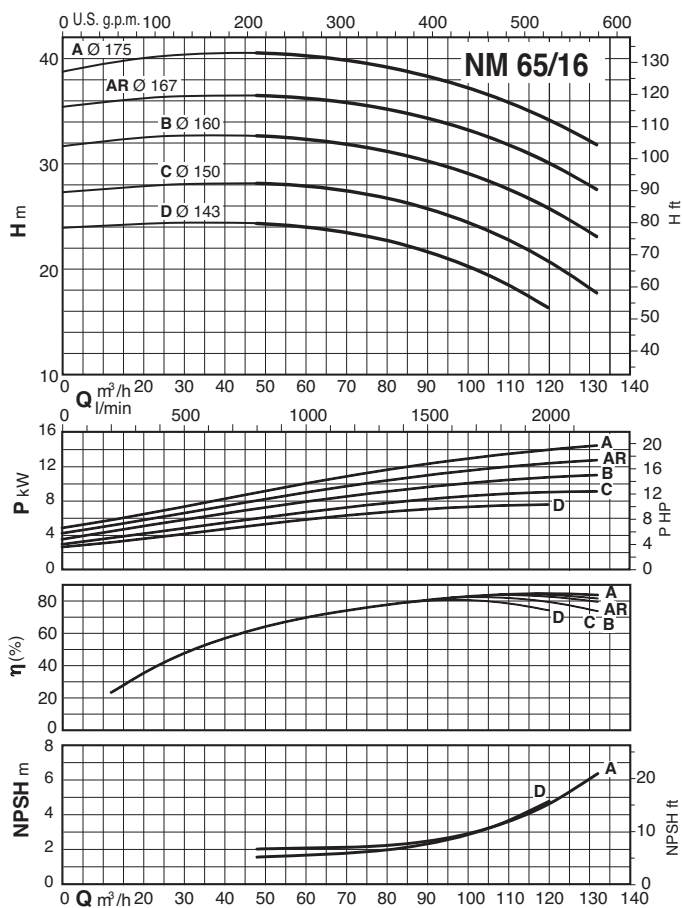
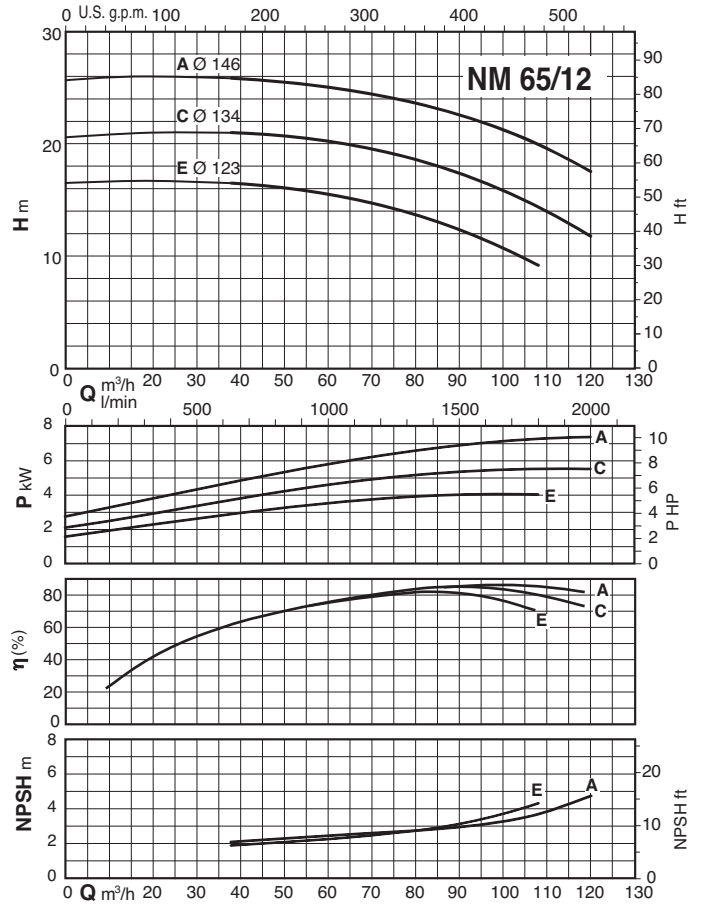
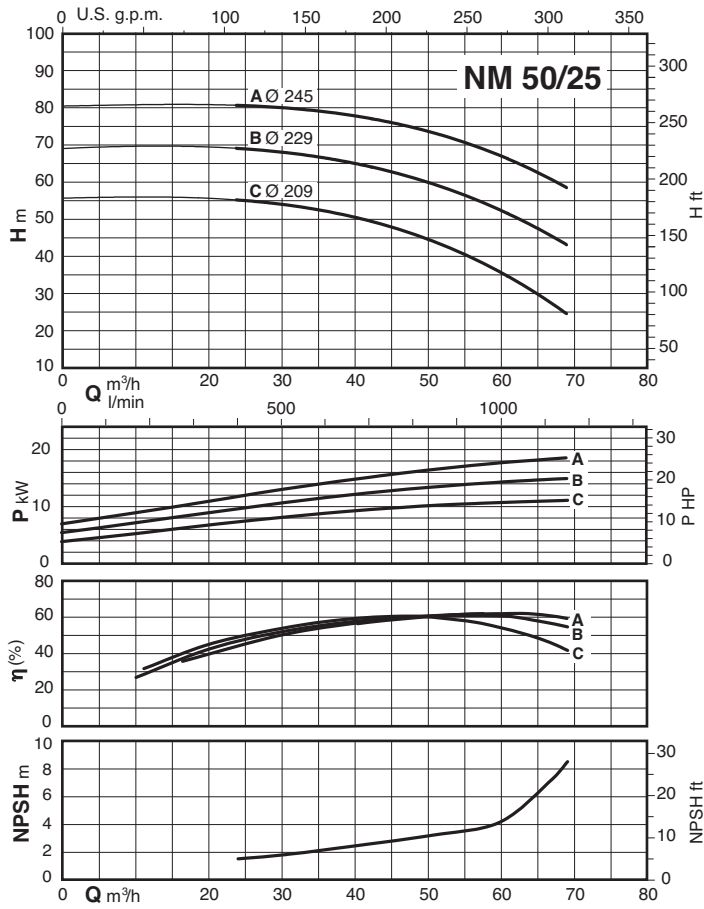

Characteristic curves $n \approx 2900$ rpm

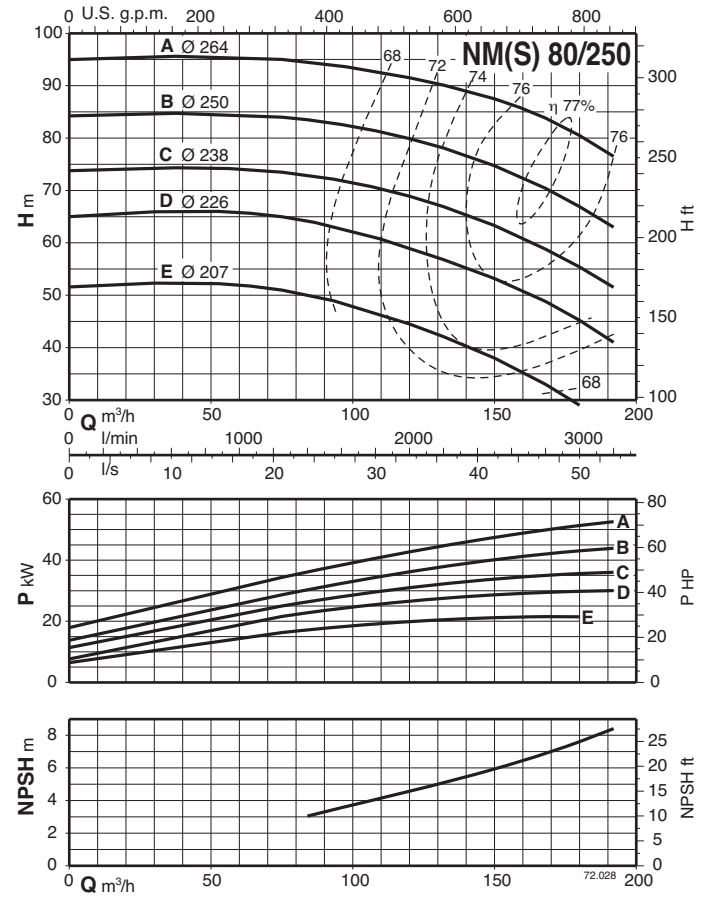
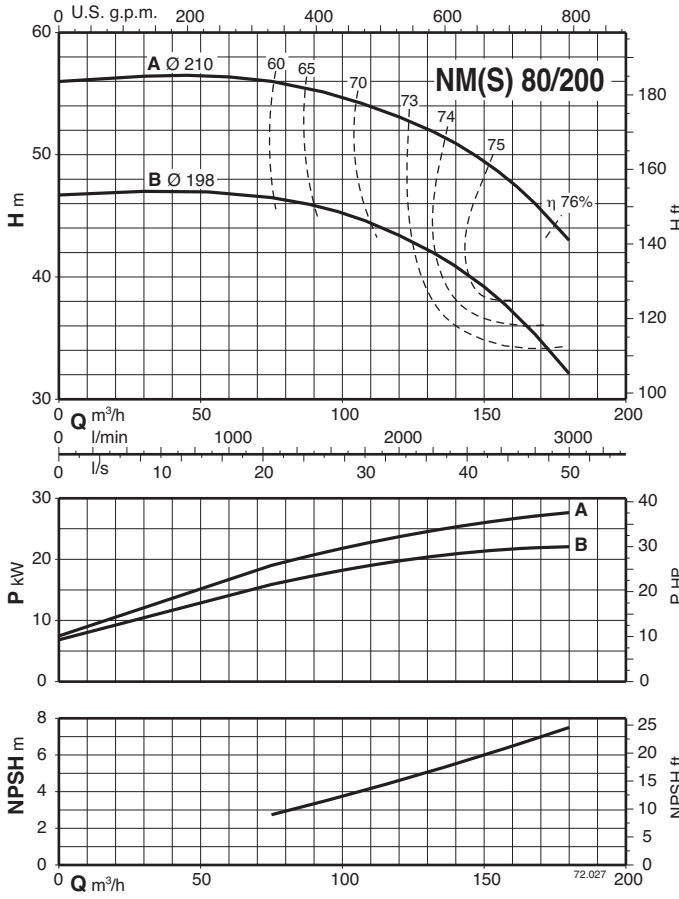
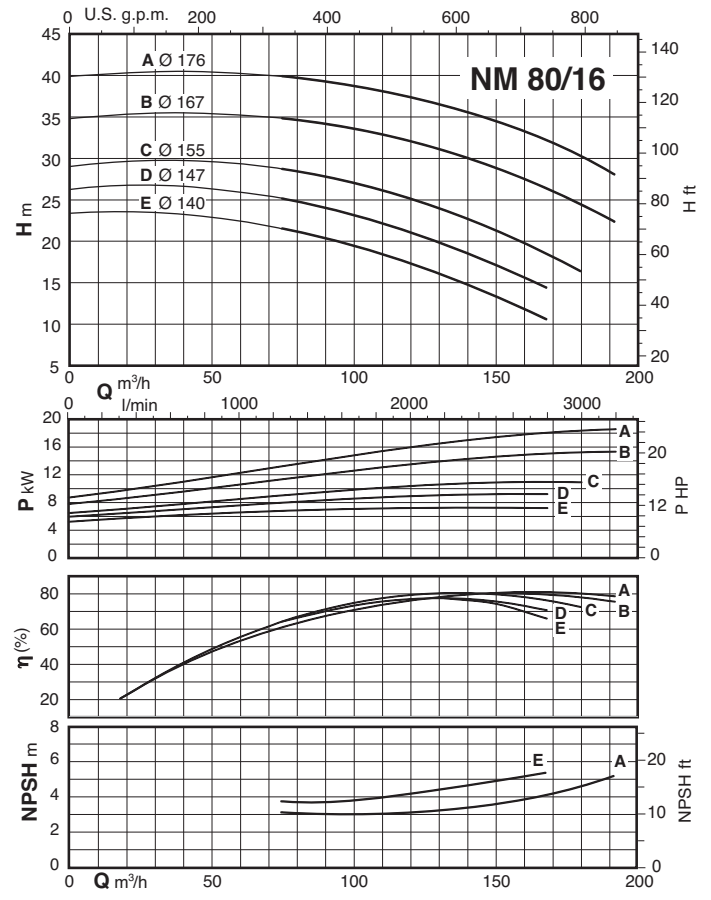
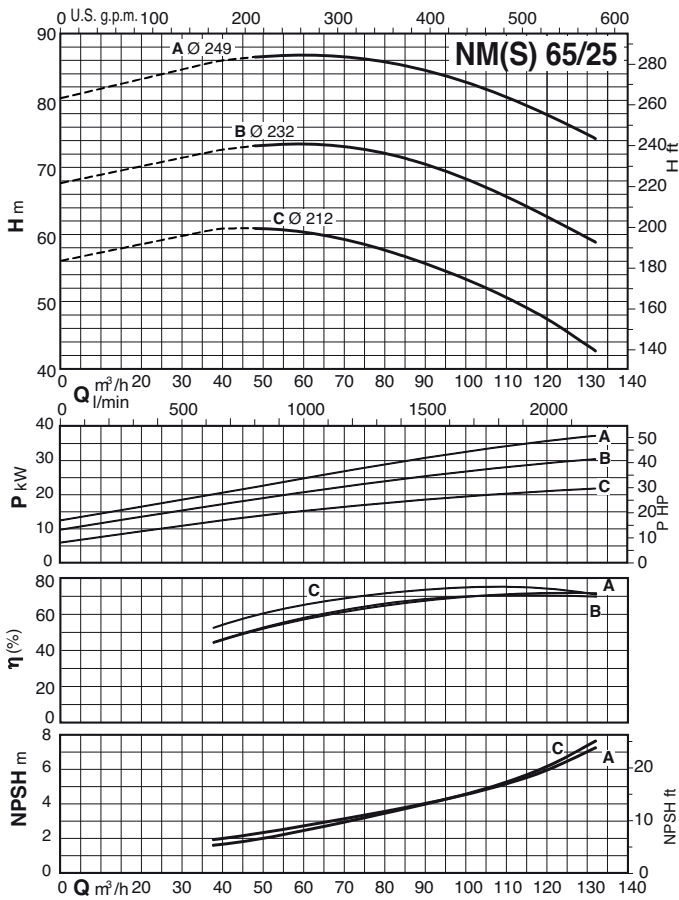

Characteristic curves $n \approx 2900$ rpm

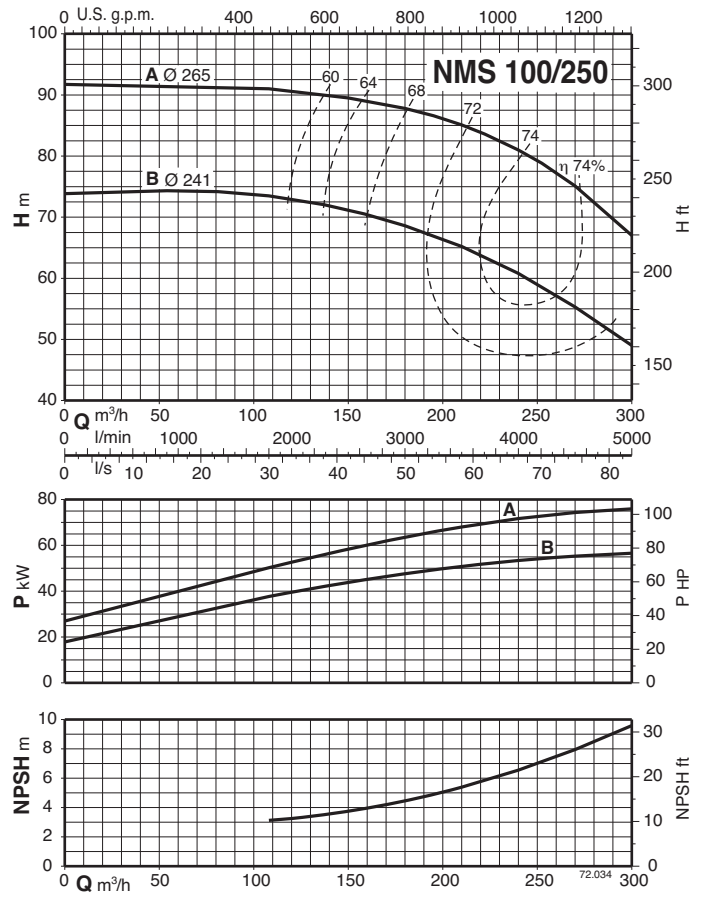
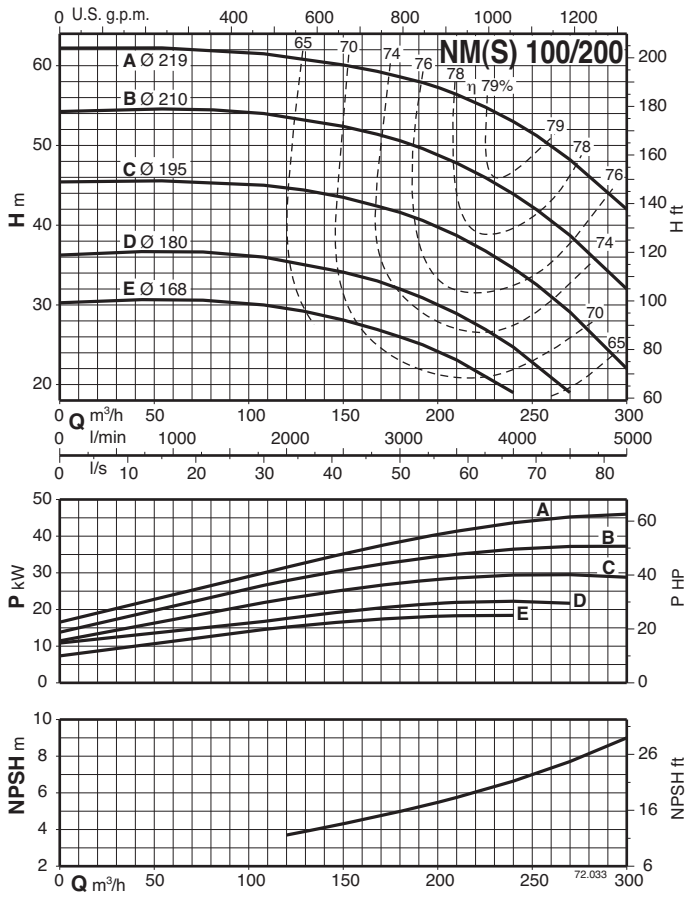

Dimensions and weights

Flanges EN 1092-2

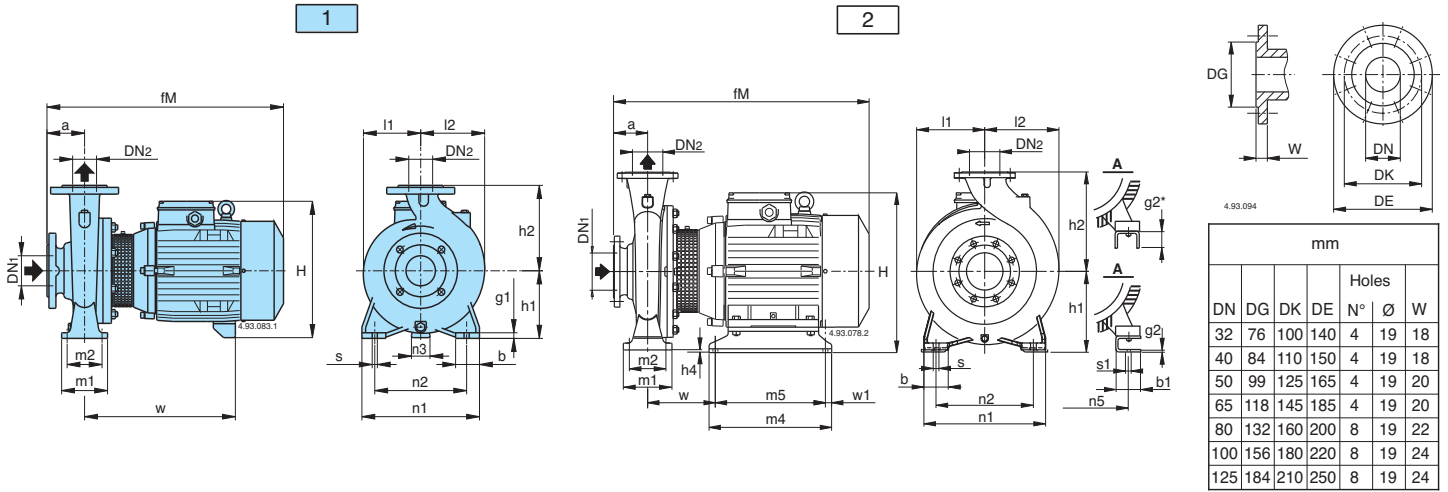

Picture	NM	mm																							kg					
		DN1	DN2	a	fM	h1	h2	H	h4	m1	m2	n1	n2	n3	n5	w1	b	b1	s	s1	l1	l2	w	m4	m5	g1	g2			
1	NM 32/12DE-FE NM 32/12S/A-A/A	50	32	80	405	112	140	240	-	100	70	190	140	37	-	-	50	-	14	-	93	97	245	-	-	12	-	24-24 27-26		
	NM 32/16B/A NM 32/16A/B	50	32	80	410 450	132	160	260	-	100	70	240	190	47	-	-	50	-	14	-	120	120	250 290	-	-	12	-	34 39		
	NM 32/20D/B NM 32/20C/A NM 32/20A/B	50	32	80	450 475 475		180	288 298 298	-	100	70	240	190	62 60 60	-	-	50	-	14	-	140	140	290 295 295	-	-	12	-	42 47 51		
	NM 32L/16C NM 32L/16B NM 32L/16A	50	32	80	450 475 475	132	160	260 270 270	-	100	70	240	190	47 45 45	-	-	50	-	14	-	121	121	290 295 295	-	-	10	-	38,6 45,6 47,6		
	NM 32L/20C NM 32L/20A-B	50	32	80	475 508	160	180	298 320	-	100	70	240	190	60 49	-	-	50	-	14	-	142	142	295 279	-	-	12	-	52 72-66		
	NM 40/12C/B-F/B NM 40/12A/C	65	40	80	410 450	112	140	240	-	100	70	210	160	37	-	-	50	-	14	-	100	113	250 290	-	-	12	-	29-27 32		
	NM 40/16C/C NM 40/16B/B NM 40/16A/C	65	40	80	450 475 475	132	160	260 270 270	-	100	70	240	190	47 45 45	-	-	50	-	14	-	121	122	290 295 295	-	-	10	-	39 46 48		
	NM 40/20C/B-D/B NM 40/20A/A-AR/A-B/A	65	40	100	495 528	160	180	298 320	-	100	70	265	212	60 49	-	-	50	-	14	-	142	142	295 279	-	-	12	-	54-53 73-67-67		
	NM 40/25C/C NM 40/25B/C NM 40/25A/C	65	40	100	640 690 715	180	225	365	-	125	95	320	250	50	-	-	65	-	14	-	175	175	400 460 460	-	-	15	-	108 117 139		
	NM 50/12F/C NM 50/12D/B NM 50/12A/C-S/C	65	50	100	470 495 495		160	260 270 270	-	100	70	240	190	47 45 45	-	-	50	-	14	-	122	137	290 295 295	-	-	10	-	40 47 50,5-50,6		
	NM 50/16A/B-B/B	65	50	100	528	160	180	320	-	100	70	265	212	49	-	-	50	-	14	-	126	140	279	-	-	12	-	70,5-64		
	NM 50/20B/C NM 50/20A/C NM 50/20S/C	65	50	100	640 690 720	160	200	345	-	100	70	265	212	40	-	-	50	-	14	-	140	153	400 460 460	-	-	15	-	100 109 131		
	NM 50/25C/C NM 50/25B/C	65	50	100	695 720	180	225	365	-	125	95	320	250	50	-	-	65	-	14	-	175	175	465 465	-	-	15	-	122 145		
	2	NM 50/25A/D	65	50	100	766	180	225	386	-	125	95	320	250	-	254	20	65	60	14	15	175	175	166	394	354	-	20*	-	
	1	NM 65/12E/C NM 65/12A/B-C/B	80	65	100	500 533	160	180	298 320	-	125	95	280	212	60 49	-	-	65	-	14	-	130	154	300 284	-	-	12	-	51,9 70,7-64,7	
		NM 65/16D/B NM 65/16C/C NM 65/16B/C NM 65/16A/C-AR	80	65	100	528 640 690 715	160	200	320 345 345 345	-	125	95	280	212	49 40 40 40	-	-	65	-	14	-	140	161	279 410 410 460	-	-	12	-	70,5 93 112 127	
		NM 65/20C/C	80	65	100	715	180	225	365	-	125	95	320	250	50	-	-	65	-	14	-	159	179	460	-	-	12	-	134	
		2	NM 65/20A/A-B/D	80	65	100	762	180	225	386	-	125	95	320	250	-	254	20	65	60	14	15	159	179	175	394	354	-	20*	--
		NM 65/25C/A	80	65	100	762	202	250	408	2	160	120	360	280	-	254	20	80	90	18	14	179	185	182	400	360	-	42*	187	
	1	NM 80/16E/B NM 80/16D/C NM 80/16C/C NM 80/16B/C	100	80	125	553 670 720 745	180	225	340 365 365 365	-	125	95	320	250	60 50 50 50	-	-	65	-	14	-	153	181	279 415 465 465	-	-	12	-	77,5 101 120 132	
2		NM 80/16A/D	100	80	125	789	180	225	386	-	125	95	320	250	-	254	20	65	60	14	15	153	181	164	394	354	-	20*	-	
NM 80/20B		100	80	125	787	202	250	408	22	125	95	345	280	-	254	20	65	90	18	14	170	194	182	400	360	-	42*	180		
NM 80/25E		100	80	125	787	202	280	408	2	160	120	400	315	-	254	20	80	90	18	14	191	210	182	400	360	-	42*	193		
2	NM 100/20D-E/A	125	100	125	787	200	280	406	-	160	120	360	280	-	254	20	80	90	18	15	180	212	162	394	354	-	40*	--		

Pumps with packed gland, dimensions available on request (excluded NMS).

Dimensions and weights

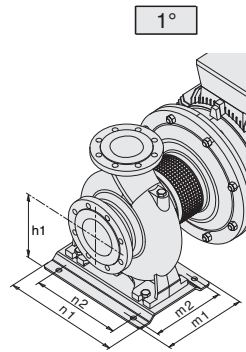
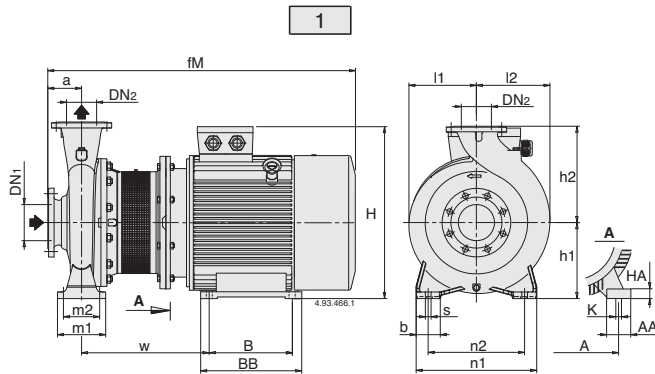

Flanges EN 1092-2

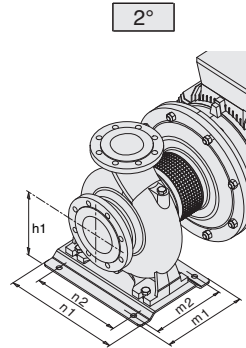
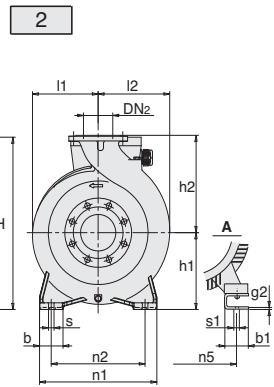
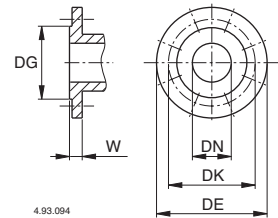

mm						
DN	DG	DK	DE	Holes		
				N°	Ø	W
32	76	100	140	4	19	18
40	84	110	150	4	19	18
50	99	125	165	4	19	20
65	118	145	185	4	19	20
80	132	160	200	8	19	22
100	156	180	220	8	19	24
125	184	210	250	8	19	24

Picture	NMS	mm																												kg	
		DN1	DN2	a	fM	h1	h2	H	m1	m2	n1	n2	A	n5	w1	b	AA	b1	s	K	s1	l1	l2	w	BB	m4	B	m5	HA		g2
2	NMS 65/250B/A	80	65	100	961	200	250	486	160	120	360	280	-	279	20	80	-	70	18	-	15	179	195	333	-	440	-	400	-	20	236
1	NMS 65/250A/B	80	65	100	1009	200	250	515	160	120	360	280	318	-	-	80	70	-	18	19	-	200	200	406	355	-	305	-	25	-	321
1	NMS 80/200A	100	80	125	986	180	250	466	125	95	345	280	279	-	-	65	65	-	14	19	-	170	194	394	328	-	279	-	20	-	222
2	NMS 80/250D	100	80	125	986	200	280	486	160	120	400	315	-	279	20	80	-	70	18	-	15	191	211	333	-	440	-	400	-	20	242
1	NMS 80/250C/A	100	80	125	1034	200	280	515	160	120	400	315	318	-	-	80	70	-	18	19	-	200	210	406	355	-	305	-	25	-	345
1°	NMS 80/250B/A	100	80	125	1129	225	280	563	298	258	410	315	356	-	-	-	80	-	18	19	-	225	225	445	361	-	311	-	34	-	437
2°	NMS 80/250A/A	100	80	125	1198	280	280	690	260	220	410	315	-	406	25	-	-	100	18	-	24	275	275	443	-	500	-	450	-	8	534
2	NMS 100/200C	125	100	125	986	200	280	486	160	120	360	280	-	279	20	80	-	70	18	-	15	180	212	333	-	440	-	400	-	20	236
1	NMS 100/200B/A	125	100	125	1034	200	280	515	160	120	360	280	318	-	-	80	70	-	18	19	-	200	212	406	355	-	305	-	25	-	338
1°	NMS 100/200A/A	125	100	125	1129	225	280	563	298	258	410	315	356	-	-	-	80	-	18	19	-	225	225	445	361	-	311	-	34	-	426
2°	NMS 100/250B/A	125	100	140	1213	280	280	690	260	220	410	315	-	440	25	-	-	100	18	-	24	275	275	443	-	500	-	450	-	8	545
1°	NMS 100/250A/A	125	100	140	1286	280	280	713	260	220	410	315	457	-	-	-	100	-	18	24	-	275	275	516	479	-	368	-	40	-	648

Dimensions and weights

Flanges EN 1092-2

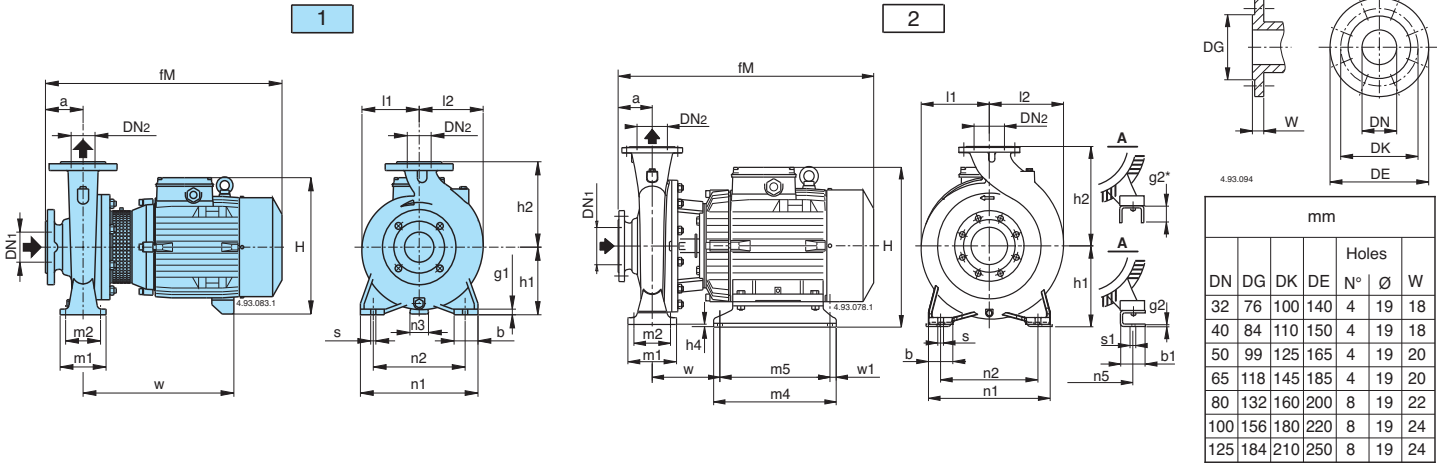

Picture	B- NM	mm																							kg			
		DN1	DN2	a	fM	h1	h2	H	h4	m1	m2	n1	n2	n3	n5	w1	b	b1	s	s1	l1	l2	w	m4	m5	g1	g2	B-NM
1	B-NM 32/12D-F B-NM 32/12S/A-A/A	50	32	80	405	112	140	240	-	100	70	190	140	37	-	-	50	-	14	-	93	97	245	-	-	12	-	27-27 30-28
	B-NM 32/16B/A B-NM 32/16A/B	50	32	80	410 450	132	160	260	-	100	70	240	190	47	-	-	50	-	14	-	120	120	250 290	-	-	12	-	38,5 42
	B-NM 32/20D/B B-NM 32/20C/A B-NM 32/20A/B	50	32	80	450 475 475	160	180	288 298 298	-	100	70	240	190	45 60 60	-	-	50	-	14	-	140	140	290 295 295	-	-	12	-	47,5 56,5 58
	B-NM 32L/16C B-NM 32L/16B/A B-NM 32L/16A/B	50	32	80	450 475 475	132	160	260 270 270	-	100	70	240	190	47 45 45	-	-	50	-	14	-	121	121	290 295 295	-	-	10	-	42,5 49,5 52,5
	B-NM 32L/20C B-NM 32L/200A-B	50	32	80	475 563	160	180	298 320	-	100	70	240	190	60 49	-	-	50	-	14	-	142	142	295 334	-	-	12	-	58,3 79,3-73,8
	B-NM 40/12C/A-F/A B-NM 40/12A/B	65	40	80	410 450	112	140	240	-	100	70	210	160	37	-	-	50	-	14	-	100	113	250 290	-	-	12	-	33-31 36
1*	B-NM 40/16C/B B-NM 40/16B/A B-NM 40/16A/B	65	40	80	450 475 475	132	160	260 270 270	-	100	70	240	190	47 45 45	-	-	50	-	14	-	121	122	290 295 295	-	-	10	-	43 50 53
	B-NM 40/20C/B-D/B B-NM 40/200A/A-AR/A-B/A	65	40	100	495 583	160	180	298 320	-	100	70	265	212	60 49	-	-	50	-	14	-	142	142	295 334	-	-	12	-	59,5-59 80,5-75
	B-NM 4025/C/C B-NM 4025/B/C B-NM 4025/A/C	65	40	100	635 685 710	192	225	377	12	125	95	320	250	-	216	20	65	69	14	12	175	175	174	298	258	-	6	124 130 159,5
1	B-NM 50/12F/B B-NM 50/12D/A B-NM 50/12A/B-S/B	65	50	100	470 495 495	132	160	260 270 270	-	100	70	240	190	47 45 45	-	-	50	-	14	-	122	137	290 295 295	-	-	10	-	44 52 54,5-54
	B-NM 50/160A/B-B/B	65	50	100	583	160	180	320	-	100	70	265	212	49	-	-	50	-	14	-	126	140	334	-	-	12	-	80-74,5
	B-NM 50/200B/C B-NM 50/200A/C B-NM 50/200S/C	65	50	100	695 745 769	192	200	377	32	100	70	265	212	-	216	20	50	69	14	12	140	153	234	298	258	-	6	123 132 154
	B-NM 5025/C/C B-NM 5025/B/C B-NM 50/25A	65	50	100	685 710 766	192	225	377	12	125	95	320	250	-	216	20	65	69	14	12	175	175	174	298	258	-	6	135 156 -
1	B-NM 65/12E/A B-NM 65/125A/B-C/B	80	65	100	500 588	160	180	298 320	-	125	95	280	212	60 49	-	-	65	-	14	-	130	154	300 339	-	-	12	-	57,3 80,5-74,5
	B-NM 65/160D/B B-NM 65/160C/C	80	65	100	583 660	160	200	320 345	-	125	95	280	212	49 40	-	-	65	-	14	-	140	179	334 430	-	-	12	-	80,2 101
2	B-NM 65/160B/C B-NM 65/160A/C-AR	80	65	100	745 770	192	200	377	32	125	95	280	212	-	216	20	65	69	14	12	140	179	234	298	258	-	6	140 152
	B-NM 65/200C/C B-NM 65/250C/B	80	65	100	775 825	192	225	377	12	125	95	320	250	-	216	20	65	69	14	12	159	179	239	298	258	-	6	160 210
	B-NM 80/160E/B B-NM 80/160D/C	100	80	125	608 685	180	225	340 365	-	125	95	320	250	60 50	-	-	65	-	14	-	153	181	334 430	-	-	12	-	89,4 109
1*	B-NM 80/160C/C B-NM 80/160B/C B-NM 80/16A	100	80	125	775 800 789	192	225	377	12	125	95	320	250	-	216	20	65	69	14	12	153	181	239	298	258	-	6	149 161 -

* Version without coupling guard

Dimensions and weights

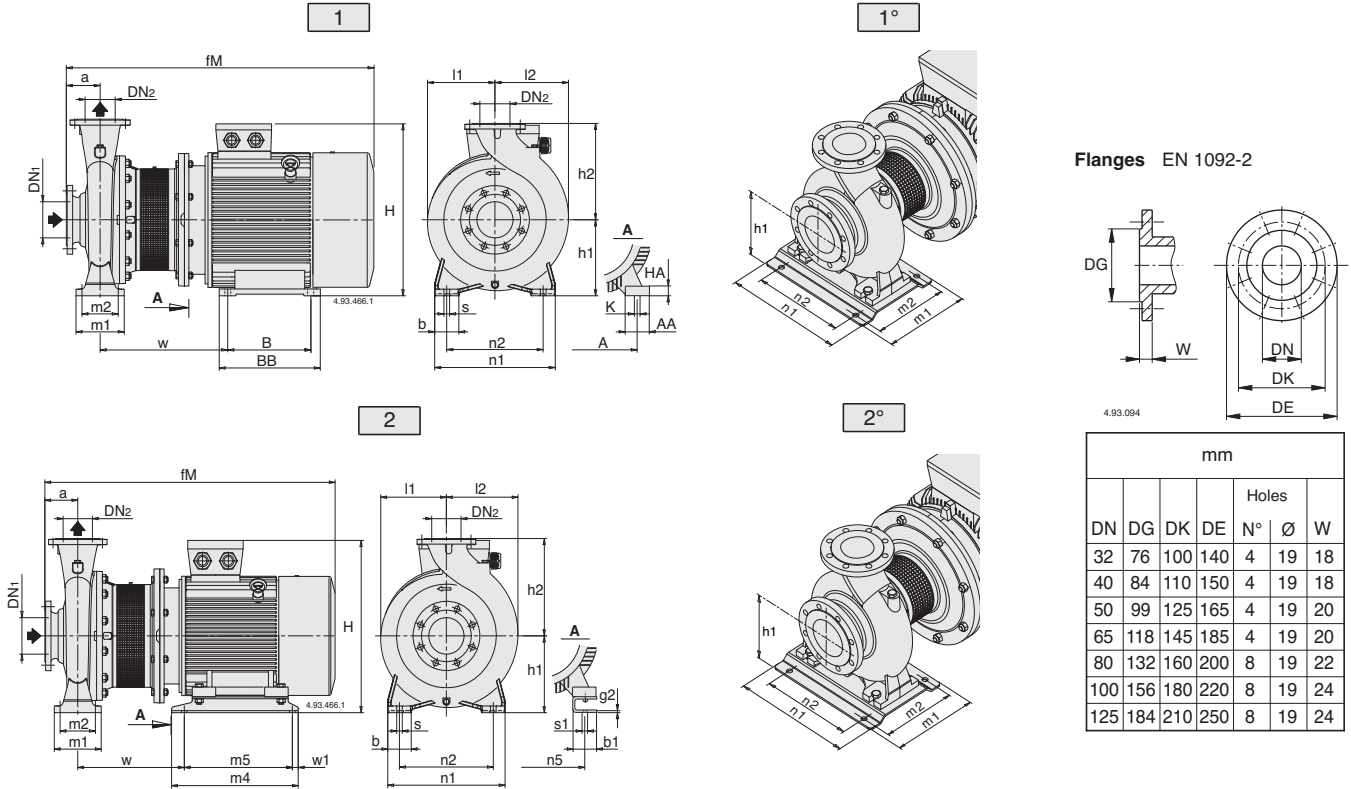

Picture	B-NMS	mm																												kg	
		DN1	DN2	a	fM	h1	h2	H	m1	m2	n1	n2	A	n5	w1	b	AA	b1	s	K	s1	l1	l2	w	BB	m4	B	m5	HA		g2
2	B-NMS 65/200A-B	80	65	100	864	180	225	386	125	95	320	350	-	254	20	65	-	60	14	-	15	159	179	331	-	394	-	354	-	20	
2	B-NMS 65/250B/A	80	65	100	961	200	250	486	160	120	360	280	-	279	20	80	-	70	18	-	15	179	195	333	-	440	-	400	-	20	
1	B-NMS 65/250A/B	80	65	100	1009	200	250	515	160	120	360	280	318	-	80	70	-	18	19	-	200	200	406	355	-	305	-	25	-	353	
2	B-NMS 80/200B/A	100	80	125	936	180	250	387	125	95	345	280	-	254	20	65	-	60	14	-	15	175	194	331	-	350	-	310	-	5	
1	B-NMS 80/200A/A	100	80	125	986	180	250	466	125	95	345	280	279	-	65	65	-	14	15	-	170	194	394	328	-	279	-	20	-	266	
2	B-NMS 80/250E/A	100	80	125	936	200	280	407	160	120	400	315	-	254	20	80	-	60	18	-	15	191	210	331	-	394	-	354	-	6	
2	B-NMS 80/250D/A	100	80	125	986	200	280	486	160	120	400	315	-	279	20	80	-	70	18	-	15	191	212	333	-	440	-	400	-	287	
1	B-NMS 80/250C/A	100	80	125	1034	200	280	515	160	120	400	315	318	-	80	70	-	18	19	-	200	210	406	355	-	305	-	25	-		
1°	B-NMS 80/250B/A	100	80	125	1129	225	280	563	298	258	410	315	356	-	-	80	-	18	19	-	225	225	445	361	-	311	-	34	-		
2°	B-NMS 80/250A/A	100	80	125	1198	280	280	690	260	220	410	315	-	406	25	-	-	100	18	-	24	275	275	443	-	500	-	450	-	8	
2	B-NMS 100/200D/A-E/B	125	100	125	936	200	280	407	160	120	360	280	-	254	20	80	-	60	18	-	15	180	212	331	-	394	-	354	-	6	
2	B-NMS 100/200C/A	125	100	128	1034	200	280	535	160	120	360	280	-	279	20	80	-	70	18	-	15	180	212	345	-	440	-	400	-	20	
1	B-NMS 100/200B/A	125	100	125	1034	200	280	515	160	120	360	280	318	-	80	70	-	18	19	-	200	212	406	355	-	305	-	25	-	352	
1°	B-NMS 100/200A/A	125	100	125	1129	225	280	563	298	258	410	315	356	-	-	80	-	18	19	-	225	225	445	361	-	311	-	34	-		
2°	B-NMS 100/250B/A	125	100	140	1213	280	280	690	260	220	410	315	-	440	25	-	-	100	18	-	24	275	275	443	-	500	-	450	-	8	
1°	B-NMS 100/250A/A	125	100	140	1286	280	280	713	260	220	410	315	457	-	-	100	-	18	24	-	275	275	516	479	-	368	-	40	-		

Features

Cutting edge hydraulics

The geometry of the impeller and the pump casing are optimized to achieve maximum efficiency and the best suction capability.

Flexible

The option to choose between cast iron and bronze materials for the hydraulic parts in contact with the pumped liquid allows NM series pumps to be selected for use with different types of liquids.

Compact Design

The compact design allows for easy installation even in confined spaces.

Exclusive design

An innovative, patented guard prevents contact with rotating parts, proving protection to the end user whilst allowing for inspection of the mechanical seal.

Reliable

The bearing and shaft are designed to ensure the reduction of the stress, providing high reliability under all operating conditions.

NM

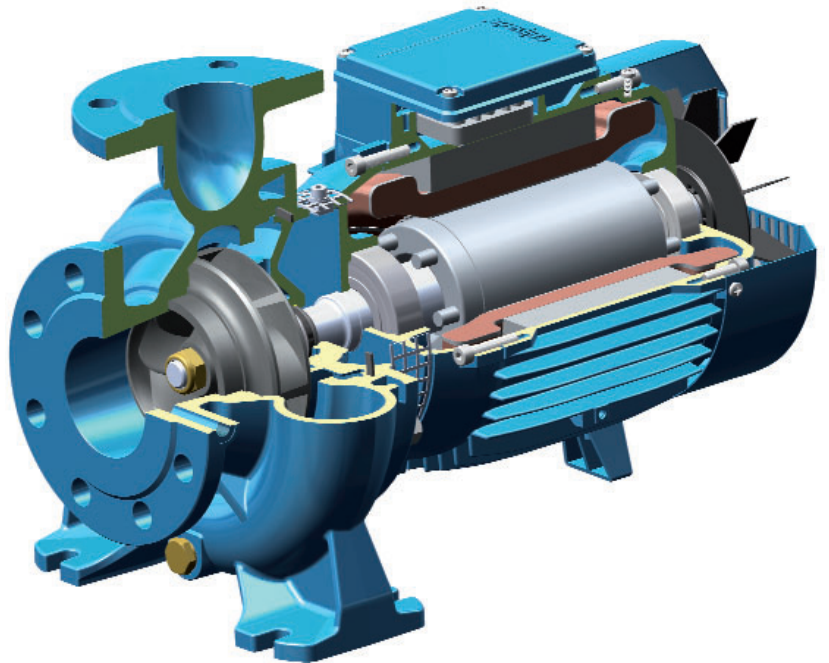

Cutting edge hydraulics

The geometry of the impeller and the pump casing are optimized to achieve maximum efficiency and the best suction capability.

Flexible

The option to choose between cast iron and bronze materials for the hydraulic parts in contact with the pumped liquid allows NMS series pumps to be selected for use with different types of liquids.

New lantern bracket construction

The lantern brackets incorporate a thrust bearing on the hydraulic side which guarantees the elimination of additional loads on the motor bearings. The flange is sized to be used with standard motors B35.

Exclusive design

An innovative, patented guard prevents contact with rotating parts, proving protection to the end user whilst allowing for inspection of the mechanical seal.

Simplified motor maintenance

The presence of the thrust bearing on the hydraulic side makes it easier to remove the motor, facilitating maintenance operations and eliminating the risks of damage to the hydraulic parts.

NMS

