

6L line



Deepwell Borehole



Submersible multistage centrifugal pumps for 6" wells. Check valve built into the delivery outlet. Pump flange for coupling with motors are made according to NEMA standards. Most common applications are civil and agricultural.

Construction features

Suction and delivery outlet	micro-casted stainless steel AISI 304
Valve	stainless steel AISI 304
Impellers and diffusers	polycarbonate Lexan
Upper bushings	NBR rubber
Shaft	stainless steel AISI 420
Quantity of sand in the water	max 400 g/m ³
Max liquid temperature	35° C



Motor 50 Hz - 2900 rpm			Q					
TYPE	Power		l/min	0	60	100	140	180
			l/sec	0	1,00	1,67	2,33	3,00
	HP	kW	m ³ /h	0	3,6	6	8,4	10,8
6L 9/06	3	2,2	H[m]	92	82	67	48	22
6L 9/08	4	3		123	109	90	63	29
6L 9/10	5,5	4		154	136	112	79	36
6L 9/14	7,5	5,5		215	191	157	111	51
6L 9/20	10	7,5		308	272	225	158	72
6L 9/24	12,5	9,2		369	327	270	190	87
6L 9/29	15	11		446	395	326	230	105
6L 9/34	17,5	13		523	463	382	269	123
6L 9/39	20	15		600	531	438	309	141

Motor 50 Hz - 2900 rpm			Q						
TYPE	Power		l/min	0	80	120	160	200	240
			l/sec	0	1,33	2,00	2,67	3,33	4,00
	HP	kW	m ³ /h	0	4,8	7,2	9,6	12	14,4
6L 12/05	3	2,2	H[m]	73	68	62	51	37	19
6L 12/07	4	3		102	96	86	72	51	27
6L 12/09	5,5	4		131	123	111	92	66	35
6L 12/12	7,5	5,5		175	164	148	123	88	46
6L 12/17	10	7,5		248	233	209	174	124	65
6L 12/20	12,5	9,2		292	274	246	205	146	77
6L 12/24	15	11		351	329	295	246	175	92
6L 12/29	17,5	13		424	397	357	297	212	112
6L 12/33	20	15		482	452	406	338	241	127

Motor 50 Hz - 2900 rpm			Q						
TYPE	Power		l/min	0	100	150	200	250	300
			l/sec	0	1,67	2,50	3,33	4,17	5,00
	HP	kW	m ³ /h	0	6	9	12	15	18
6L 14/05	4	3	H[m]	75	72	67	60	49	34
6L 14/06	5,5	4		90	87	81	72	59	40
6L 14/08	7,5	5,5		120	116	108	96	78	54
6L 14/12	10	7,5		180	174	162	144	117	80
6L 14/14	12,5	9,2		210	203	189	168	137	94
6L 14/17	15	11		255	246	229	204	166	114
6L 14/20	17,5	13		300	289	269	240	195	134
6L 14/23	20	15		345	333	310	276	225	154
6L 14/29	25	18,5		435	420	391	348	283	194
6L 14/34	30	22		510	492	458	408	332	228

6L

6L 17

Motor 50 Hz - 2900 rpm			Q							
TYPE	Power		l/min	0	150	200	250	300	350	400
			l/sec	0	2,50	3,33	4,17	5,00	5,83	6,67
	HP	kW	m ³ /h	0	9	12	15	18	21	24
6L 17/04	4	3	H[m]	59	56	52	45	37	27	18
6L 17/05	5,5	4		74	71	65	56	46	34	22
6L 17/07	7,5	5,5		103	99	91	79	65	48	31
6L 17/09	10	7,5		133	127	117	102	84	62	40
6L 17/12	12,5	9,2		177	169	156	135	111	82	53
6L 17/14	15	11		207	197	182	158	130	96	62
6L 17/16	17,5	13		236	226	208	181	149	110	71
6L 17/19	20	15		281	268	247	215	177	131	85
6L 17/23	25	18,5		340	324	299	260	214	158	102
6L 17/28	30	22		413	395	364	316	260	192	125
6L 17/33	35	26		487	465	429	373	307	227	147
6L 17/38	40	30		561	536	494	429	353	261	169

6L 23

Motor 50 Hz - 2900 rpm			Q						
TYPE	Power		l/min	0	200	300	400	500	600
			l/sec	0	3,33	5,00	6,67	8,33	10,00
	HP	kW	m ³ /h	0	12	18	24	30	36
6L 23/03	4	3	H[m]	41	35	31	26	17	5
6L 23/04	5,5	4		55	46	41	34	22	6
6L 23/06	7,5	5,5		83	69	62	51	33	9
6L 23/08	10	7,5		110	92	82	68	45	12
6L 23/10	12,5	9,2		138	115	103	85	56	15
6L 23/12	15	11		165	138	124	102	67	18
6L 23/14	17,5	13		193	161	144	119	78	21
6L 23/16	20	15		220	184	165	136	89	24
6L 23/20	25	18,5		275	230	206	170	112	30
6L 23/24	30	22		330	276	247	204	134	36
6L 23/28	35	26		385	322	288	238	156	42
6L 23/33	40	30		454	380	340	281	184	50

6L 35

Motor 50 Hz - 2900 rpm			Q							
TYPE	Power		l/min	0	300	400	500	600	700	800
			l/sec	0	5,00	6,67	8,33	10,00	11,67	13,33
	HP	kW	m ³ /h	0	18	24	30	36	42	48
6L 35/04	7,5	5,5	H[m]	55	48	44	37	30	20	8
6L 35/05	10	7,5		68	60	54	47	37	24	11
6L 35/07	12,5	9,2		96	84	76	65	52	34	15
6L 35/08	15	11		109	96	87	75	60	39	17
6L 35/09	17,5	13		123	108	98	84	67	44	19
6L 35/11	20	15		150	132	120	103	82	54	23
6L 35/13	25	18,5		178	156	142	121	97	64	27
6L 35/16	30	22		219	192	174	149	119	78	34
6L 35/19	35	26		260	228	207	177	141	93	40
6L 35/22	40	30		301	264	240	205	164	108	46
6L 35/27	50	37		369	324	294	252	201	132	57



6L 36

Motor 50 Hz - 2900 rpm			Q						
TYPE	Power		l/min	0	300	400	500	600	700
			l/sec	0	5	6,67	8	10	11,67
	HP	kW	m ³ /h	0	18	24	30	36	42
6L 36/03	4,0	3	H[m]	37	30	28	25	22	17
6L 36/04	5,5	4		49	40	37	34	29	23
6L 36/06	7,5	5,5		74	59	56	50	43	35
6L 36/08	10	7,5		98	79	74	67	58	46
6L 36/10	12,5	9,2		123	99	93	84	72	58
6L 36/12	15	11		147	119	112	101	86	69
6L 36/14	17,5	13		172	139	130	118	101	81
6L 36/16	20	15		196	158	149	134	115	92
6L 36/20	25	18,5		245	198	186	168	144	115
6L 36/23	30	22		282	228	214	193	166	132
6L 36/28	35	26		343	277	260	235	202	161
6L 36/32	40	30		392	317	298	269	230	184
6L 36/39	50	37		478	386	363	328	281	224

6L 43

Motor 50 Hz - 2900 rpm			Q							
TYPE	Power		l/min	0	400	500	600	700	800	900
			l/sec	0	6,67	8,33	10	11,67	13,33	15
	HP	kW	m ³ /h	0	24	30	36	42	48	54
6L 43/03	5,5	4	H[m]	35	29	27	26	23	19	15
6L 43/04	7,5	5,5		46	39	37	34	30	25	20
6L 43/06	10	7,5		69	59	55	51	45	38	30
6L 43/07	12,5	9,2		81	68	64	60	53	44	35
6L 43/09	15	11		104	88	82	77	68	57	45
6L 43/11	17,5	13		127	107	101	94	83	70	55
6L 43/12	20	15		138	117	110	102	90	76	60
6L 43/15	25	18,5		173	146	137	128	113	95	75
6L 43/18	30	22		207	176	165	153	135	114	90
6L 43/22	35	26		253	215	201	187	165	140	110
6L 43/25	40	30		288	244	229	213	188	159	125
6L 43/31	50	37		357	302	284	264	233	197	155

6L

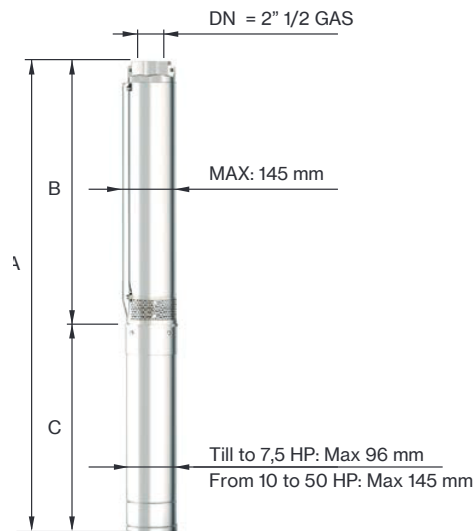

6L 9

Motor 50 Hz 2900 rpm	DIMENSIONS (mm)			Weight (kg)	
TYPE	A 3- 400 V	B	C 3-	M 3-	P
6L 9/06	955	503	452	15	16
6L 9/08	1112	555	557	19	17
6L 9/10	1204	607	597	22	18
6L 9/14	1409	711	698	27	20
6L 9/20	1568	867	701	55	23
6L 9/24	1754	1003	751	60	25
6L 9/29	1944	1133	811	65	28
6L 9/34	2104	1263	841	70	30
6L 9/39	2324	1393	931	75	33

Max Eff. % =	56
Max kW / St. =	0,370

Q (flow)	25%	50%	75%	100%
NPSH (m)	2,2	2,2	3	4,8

6L 12

Motor 50 Hz 2900 rpm	DIMENSIONS (mm)			Weight (kg)	
TYPE	A 3- 400 V	B	C 3-	M 3-	P
6L 12/05	921	469	452	15	14
6L 12/07	1078	521	557	19	16
6L 12/09	1170	573	597	22	18
6L 12/12	1349	651	698	27	21
6L 12/17	1456	755	701	55	25
6L 12/20	1584	833	751	60	28
6L 12/24	1780	969	811	65	32
6L 12/29	1914	1073	841	70	36
6L 12/33	2108	1177	931	75	40

Max Eff. % =	61
Max kW / St. =	0,451

Q (flow)	25%	50%	75%	100%
NPSH (m)	2,2	2,2	3	4,8



6L

6L 14

Motor 50 Hz 2900 rpm	DIMENSIONS (mm)			Weight (kg)	
TYPE	A 3- 400 V	B	C 3-	M 3-	P
6L 14/05	1079	522	557	19	17
6L 14/06	1154	557	597	22	17
6L 14/08	1325	627	698	27	19
6L 14/12	1468	767	701	55	21
6L 14/14	1588	837	751	60	23
6L 14/17	1753	942	811	65	25
6L 14/20	1920	1079	841	70	27
6L 14/23	2115	1184	931	75	29
6L 14/29	2385	1394	991	83	33
6L 14/34	2640	1569	1071	92	37

Max Eff. % =	62,5
Max kW / St. =	0,65

Q (flow)	25%	50%	75%	100%
NPSH (m)	2,2	2,2	3	4,8

6L 17

Motor 50 Hz 2900 rpm	DIMENSIONS (mm)			Weight (kg)	
TYPE	A 3- 400 V	B	C 3-	M 3-	P
6L 17/04	1044	487	557	19	16
6L 17/05	1119	522	597	22	17
6L 17/07	1290	592	698	27	19
6L 17/09	1363	662	701	55	21
6L 17/12	1518	767	751	60	23
6L 17/14	1648	837	811	65	25
6L 17/16	1748	907	841	70	27
6L 17/19	1943	1012	931	75	29
6L 17/23	2143	1152	991	83	33
6L 17/28	2398	1327	1071	92	37
6L 17/33	2683	1502	1181	100	41
6L 17/38	2928	1677	1251	108	45

Max Eff. % =	60
Max kW / St. =	0,793

Q (flow)	25%	50%	75%	100%
NPSH (m)	3	3	4	6

6L 23

Motor 50 Hz 2900 rpm	DIMENSIONS (mm)			Weight (kg)	
TYPE	A 3- 400 V	B	C 3-	M 3-	P
6L 23/03	1036	479	557	19	16
6L 23/04	1120	523	597	22	16
6L 23/06	1309	611	698	27	18
6L 23/08	1400	699	701	55	20
6L 23/10	1538	787	751	60	22
6L 23/12	1686	875	811	65	23
6L 23/14	1804	963	841	70	25
6L 23/16	1982	1051	931	75	27
6L 23/20	2218	1227	991	83	30
6L 23/24	2474	1403	1071	92	33
6L 23/28	2760	1579	1181	100	37
6L 23/33	3050	1799	1251	108	41

Max Eff. % =	60,5
Max kW / St. =	0,919

Q (flow)	25%	50%	75%	100%
NPSH (m)	3	3	4,5	6,6



6L

6L 35

Motor 50 Hz 2900 rpm	DIMENSIONS (mm)			Weight (kg)	
TYPE	A 3- 400 V	B	C 3-	M 3-	P
6L 35/04	1281	583	698	27	17
6L 35/05	1343	642	701	55	19
6L 35/07	1511	760	751	60	21
6L 35/08	1630	819	811	65	22
6L 35/09	1719	878	841	70	23
6L 35/11	1927	996	931	75	25
6L 35/13	2105	1114	991	83	27
6L 35/16	2362	1291	1071	92	31
6L 35/19	2649	1468	1181	100	34
6L 35/22	2896	1645	1251	108	37
6L 35/27	3281	1940	1341	118	43

Max Eff. % =	57
Max kW / St. =	1,39

Q (flow)	25%	50%	75%	100%
NPSH (m)	3,4	3,4	3,8	8

6L 36

Motor 50 Hz 2900 rpm	DIMENSIONS (mm)			Weight (kg)	
TYPE	A 3- 400 V	B	C 3-	M 3-	P
6L 36/03	1020	568	452	15	13
6L 36/04	1261	664	597	22	14
6L 36/06	1554	856	698	27	15,5
6L 36/08	1866	1048	818	32	16
6L 36/10	1991	1240	751	60	17,5
6L 36/12	2243	1432	811	65	19
6L 36/14	2465	1624	841	70	21
6L 36/16	2747	1816	931	75	25
6L 36/20	3191	2200	991	83	27
6L 36/23	3559	2488	1071	92	29
6L 36/28	4149	2968	1181	100	32
6L 36/32	4603	3352	1251	108	35
6L 36/39	5365	4024	1341	118	40

Max Eff. % =	76,3
Max kW / St. =	0,93

Q (flow)	25%	50%	75%	100%
NPSH (m)	3,4	3,4	4	6

6L 43

Motor 50 Hz 2900 rpm	DIMENSIONS (mm)			Weight (kg)	
TYPE	A 3- 400 V	B	C 3-	M 3-	P
6L 43/03	1165	568	597	22	13
6L 43/04	1362	664	698	27	14
6L 43/06	1674	856	818	32	15,5
6L 43/07	1703	952	751	60	16
6L 43/09	1955	1144	811	65	17,5
6L 43/11	2177	1336	841	70	19
6L 43/12	2363	1432	931	75	21
6L 43/15	2711	1720	991	83	25
6L 43/18	3079	2008	1071	92	27
6L 43/22	3573	2392	1181	100	29
6L 43/25	3931	2680	1251	108	32
6L 43/31	4597	3256	1341	118	35

Max Eff. % =	74
Max kW / St. =	1,18

Q (flow)	25%	50%	75%	100%
NPSH (m)	3,4	3,6	4,5	6,5



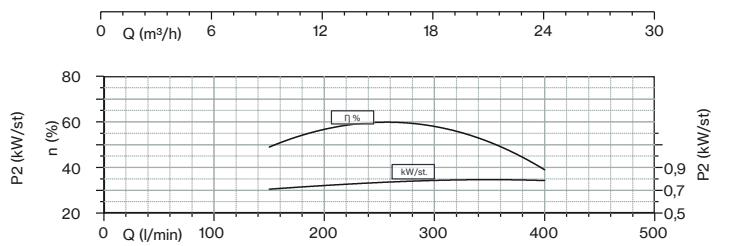
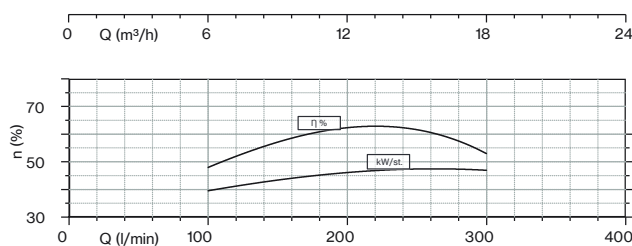
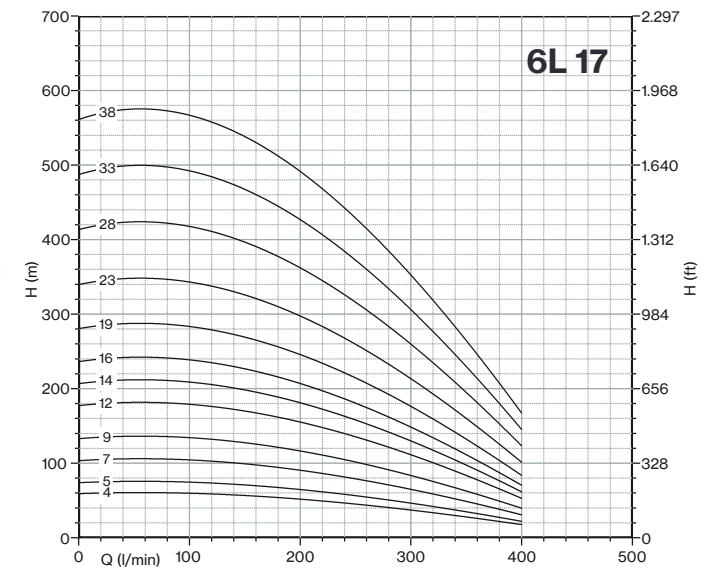
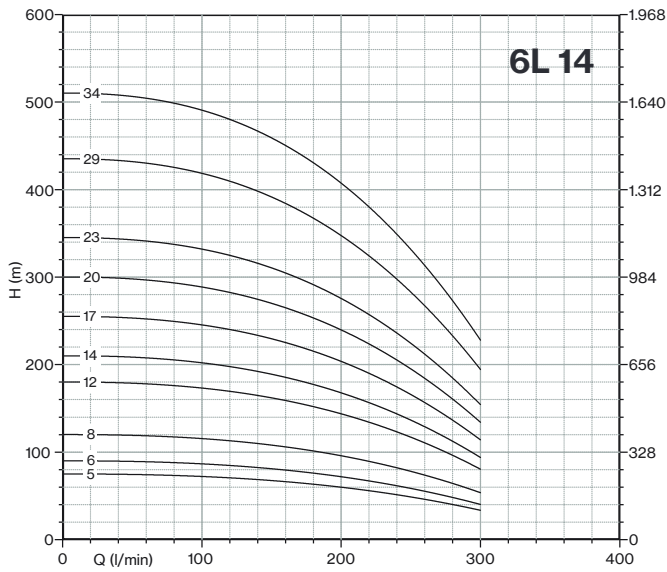
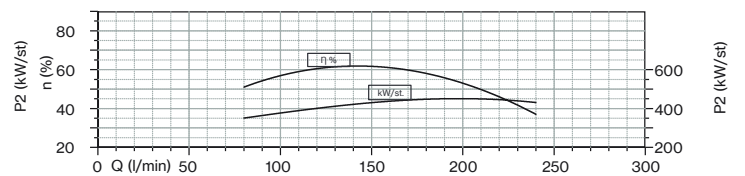
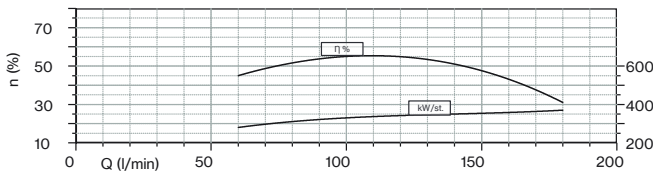
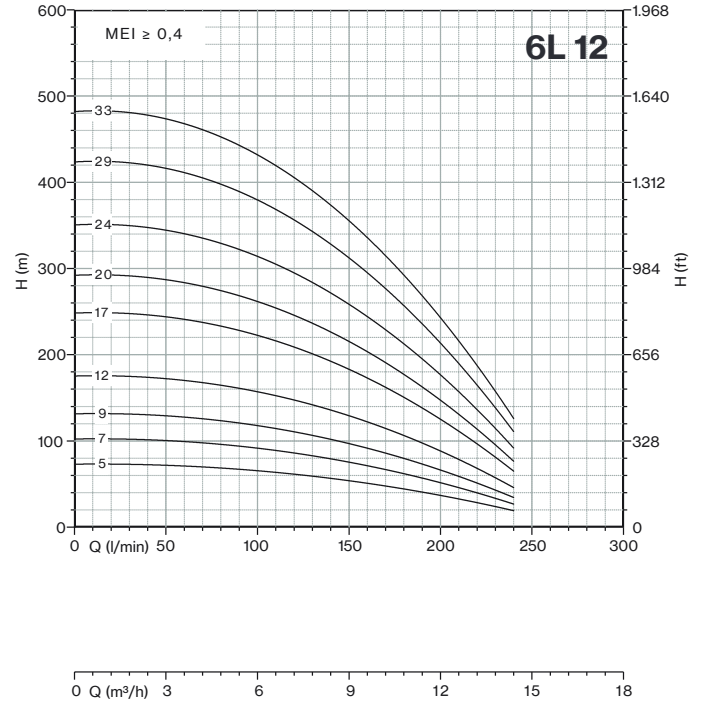
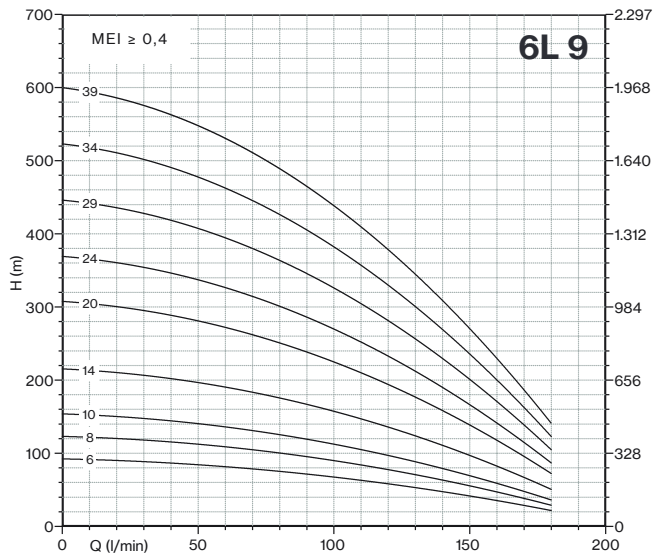

6L

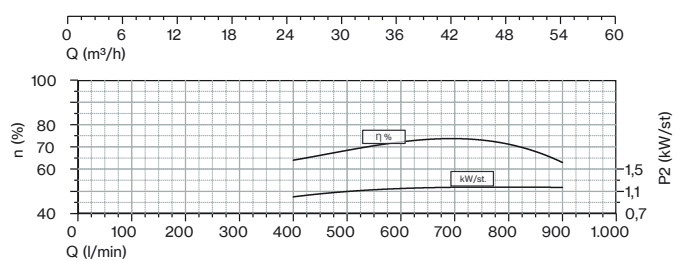
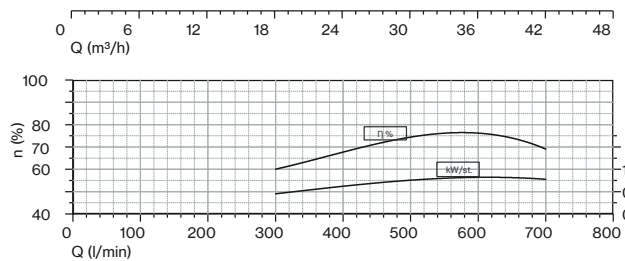
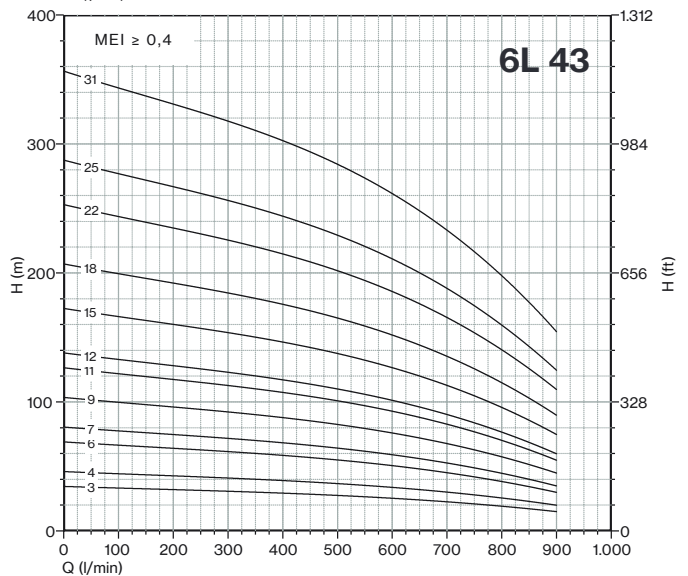
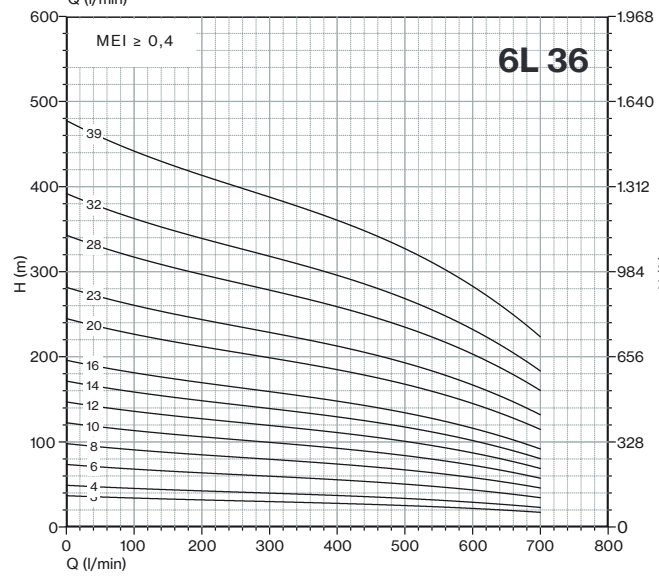
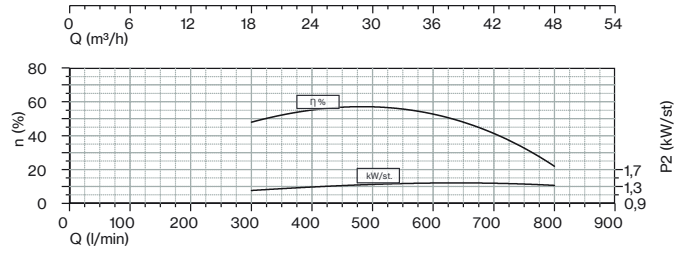
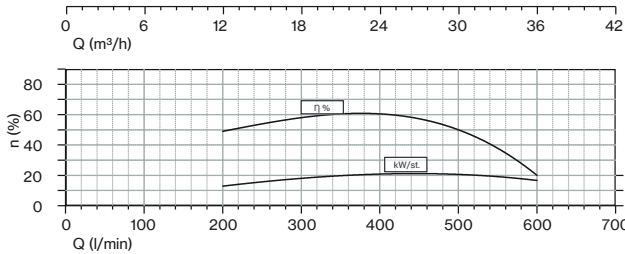
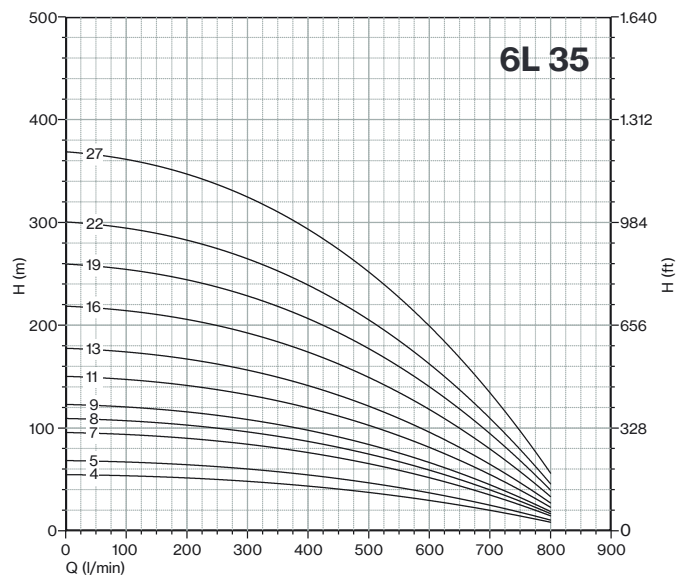
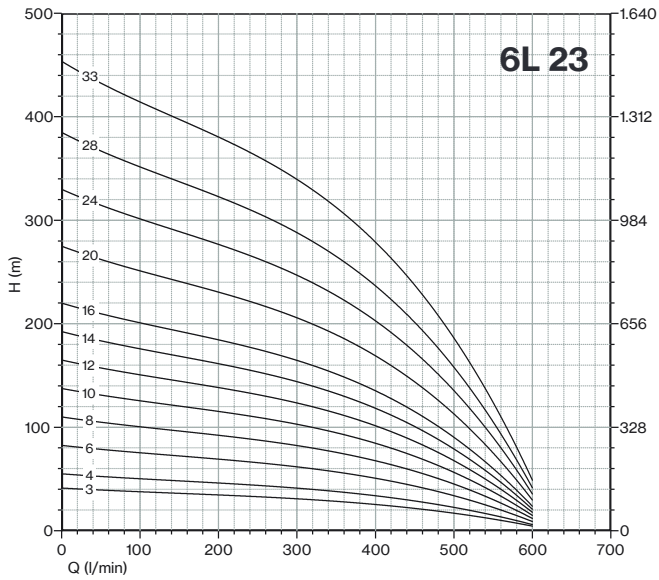

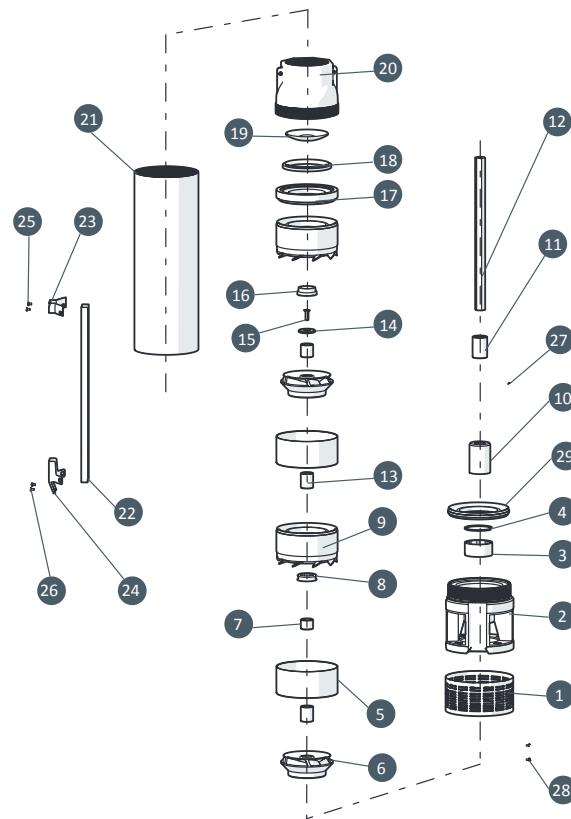

N. CODE	DESCRIPTION	MATERIAL
1	SUCTION STRAINER	AISI 304
2	SUCTION CAGE	CAST IRON
3	BEARING BUSH FOR SUCTION CAGE RUBBER NBR	RUBBER NBR
4	BEARING BUSH	AISI 304
5	INTERMEDIATE CASING	AISI 304
6	IMPELLER	NORYL GFN2
7	INTERMEDIATE SPACER	AISI 304
8	DIFFUSER BEARING BUSH	RUBBER NBR
9	DIFFUSER	NORYL GFN2 +RING AISI 304
10	JOINT	AISI 304
11	SPACER FIRST IMPELLER	NORYL GFN2
12	PUMP SHAFT	AISI 420
13	SPACER	NORYL GFN2
14	RING	AISI 304
15	SCREW	AISI 304
16	COUNTERTHRUST	PTFE+25%CARBON
17	RING GASKET VALVE	NORYL GFN2
18	GASKET VALVE	RUBBER NBR
19	CAP VALVE	AISI 304
20	DELIVERY BOWL	AISI 304
21	SLEEVE	AISI 304
22	COVER CABLE	AISI 304
23	UPPER FLANGE	AISI 304
24	LOWER FLANGE	AISI 304
25	N.2 SCREW M4X10 FOR UPPER FLANGE	AISI 304
26	N.2 SCREW M4X10 FOR LOWER FLANGE	AISI 304
27	SCREW	AISI 304
28	N.2 SCREW M4X8 SUCTION STRAINER	AISI 304
29	RING FOR SUCTION CAGE	NORYL GFN2 + RING AISI 304