

ULTRA LG



Multistage Vertical

Stainless steel multistage vertical pumps. Pumping of clean non-loaded fluids, pressurizing system, irrigation, drinking and glycol water, water treatment, food industry, heating and air conditioning, washing system.

Construction features

Pump body	cast iron
Motor bracket	cast iron
Impellers, diffusers	Noryl®
Shell, motor shaft	stainless steel AISI 304
Mechanical seal	ceramic-graphite-EPDM graphite-silicon carbide-EPDM
Intermediate shaft guiding stage bush	ceramic-tungsten carbide
Ambient temperature	max 40 °C
Liquid temperature	+5 ÷ +35 °C
Max operating pressure	14 bar
Pump body gasket	EPDM

Motor

2 pole induction motor	3- 400/690V-50Hz P > 4kW
Insulation class	F
Protection degree	IPX5



U18 S V/ X/ G - 920/10 T

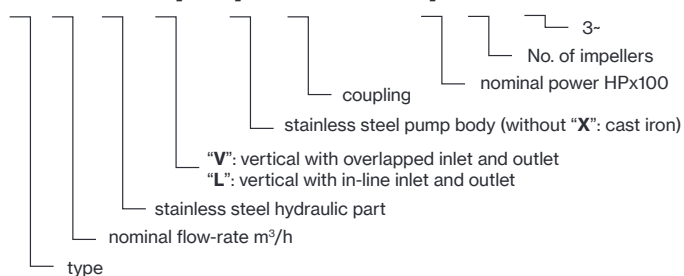

ULTRA V/L

TYPE	P2		P1 (kW)	A	Q (m³/h - l/min)									
					3~									
					0	6	7,2	9,6	12	14,4	16,8	19,2	21,6	24
3~	HP	kW	3~	3x400 V 50 Hz	H (m)									
					0	100	120	160	200	240	280	320	360	400
U 18...-250/3 T	2,5	1,85	2,19	4,3	34,5	32,0	31,6	30,1	28,1	25,5	22,5	18,7	14,4	10,0
U 18...-400/4 T	4	3	3,0	5,8	47,1	45,4	45,2	44,3	42,6	40,0	36,0	30,6	24,6	17,8
U 18...-450/5 T	4,5	3,37	3,9	6,9	59,2	57,6	57,4	56,4	54,5	51,6	46,7	40,1	33,3	25,3
U 18...-550/6 T	5,5	4	4,6	8,4	71,4	69,7	69,6	68,2	65,7	62,2	56,3	48,0	39,4	29,4
U 18...-750/8 T	7,5	5,5	6,2	11,2	96,1	94,2	94,1	92,4	89,1	84,5	77,0	66,1	54,2	41,1
U 18...-900/9 T	10	7,5	6,9	12,8	108,5	106,9	107,0	105,3	101,7	96,8	88,6	75,9	62,6	47,8

ULTRA LG

TYPE	P2		P1 (kW)	A	Q (m³/h - l/min)									
					3~									
					0	6	7,2	9,6	12	14,4	16,8	19,2	21,6	22,8
3~	HP	kW	3~	3x400 V 50 Hz	H (m)									
					0	100	120	160	200	240	280	320	360	380
U 18LG-920/10T	10	7,5	7,7	14,0	120,4	116,8	118,3	116,6	112,6	104,4	96,3	85,8	67,8	60,1
U 18LG-1000/11T	10	7,5	8,3	13,6	132,4	128,9	130,0	128,0	123,0	115,0	103,9	93,0	72,6	63,4

ULTRA V/L

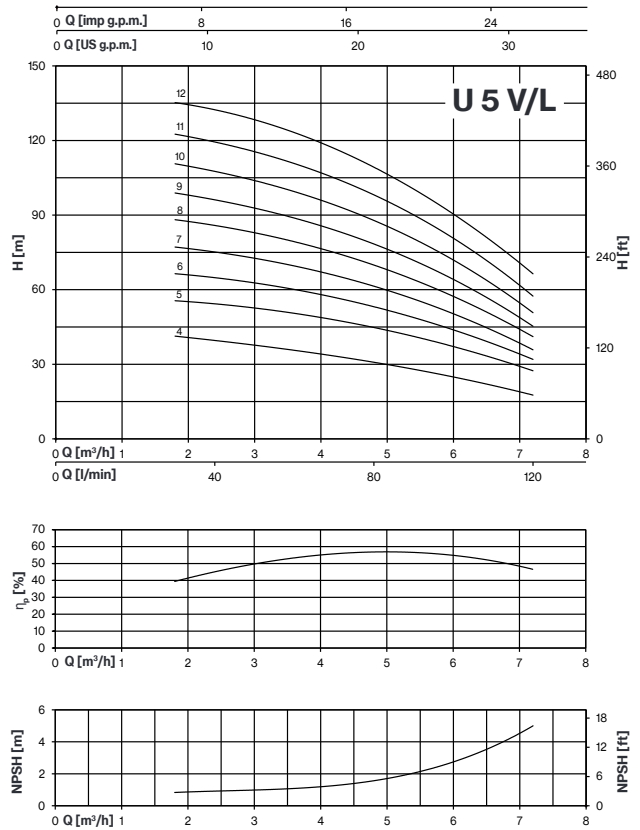
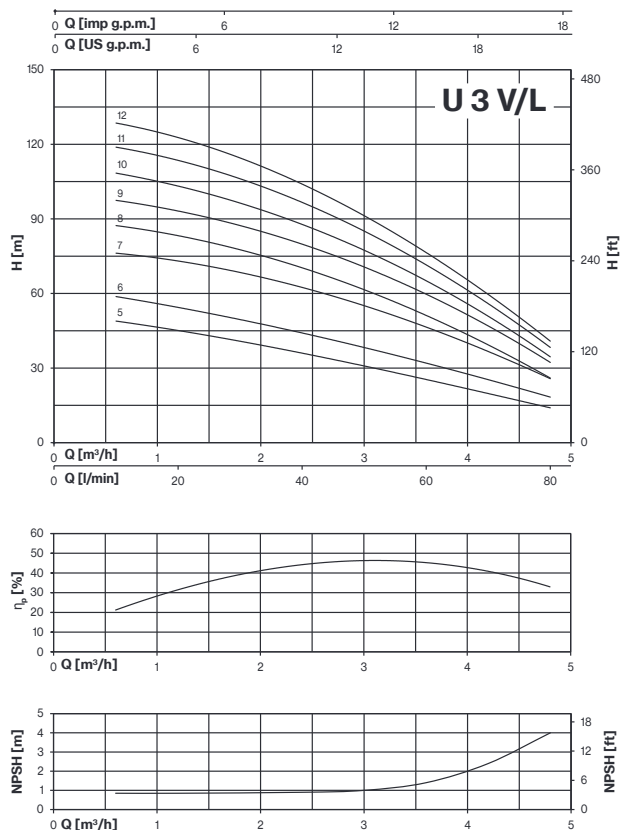

ULTRA V/L-LG

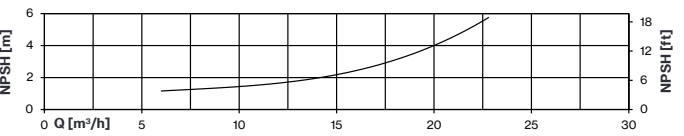
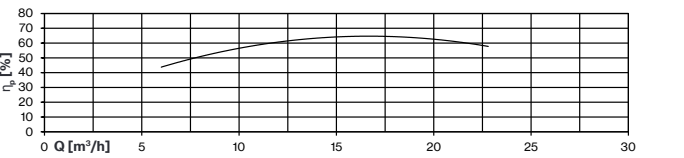
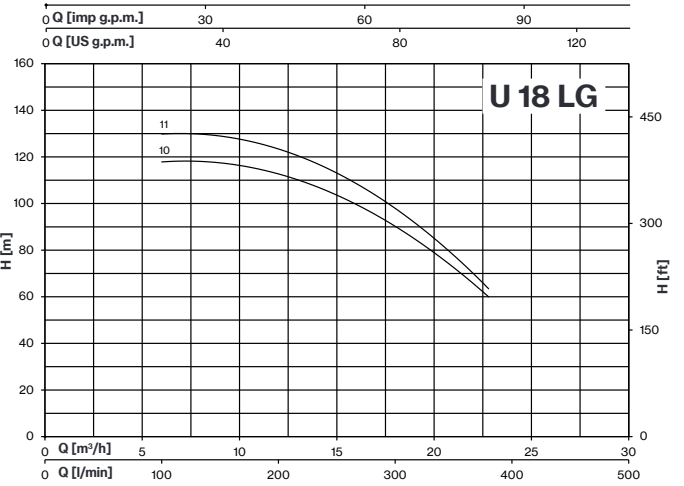
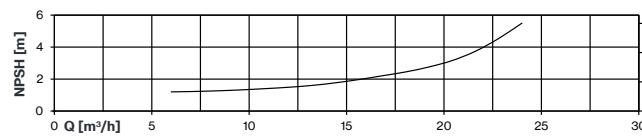
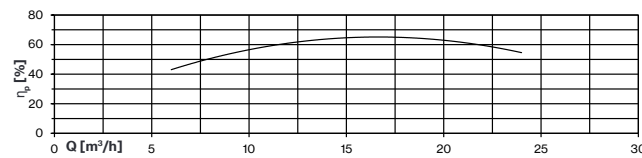
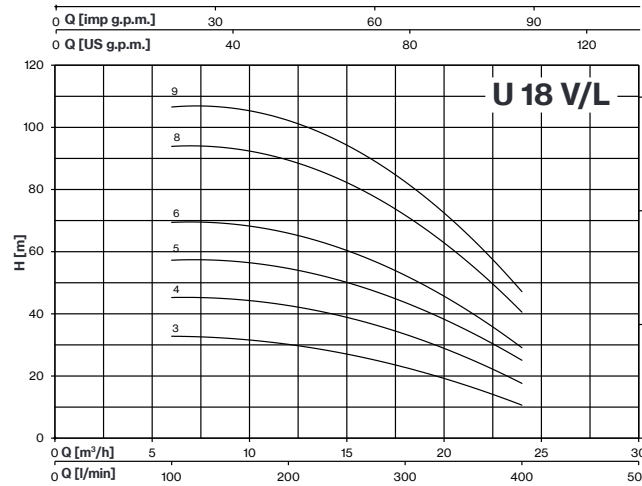
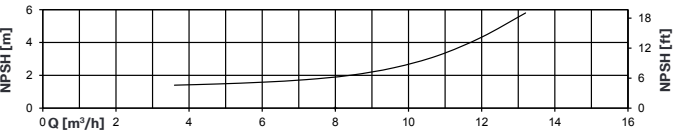
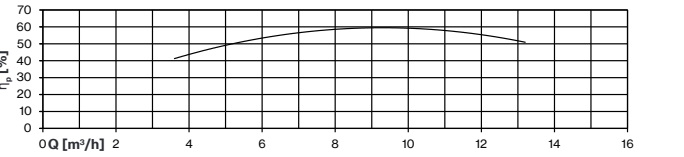
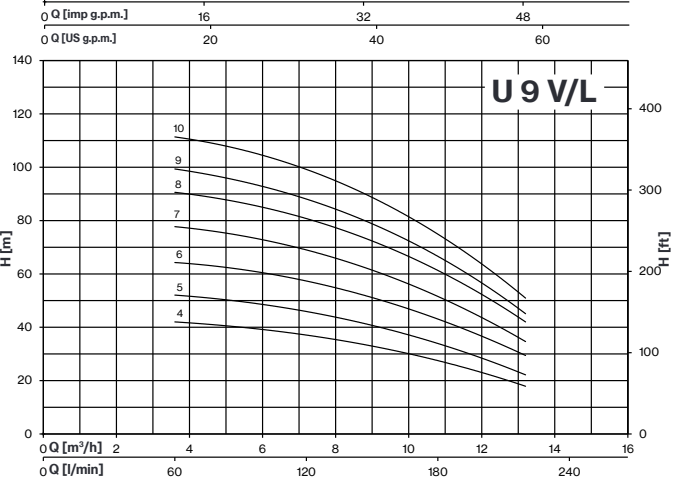
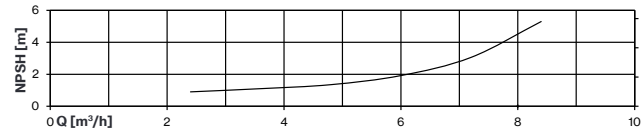
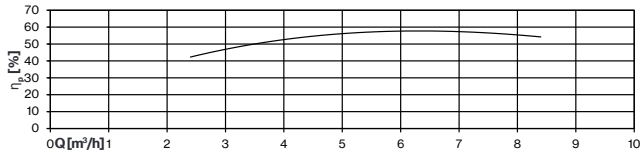
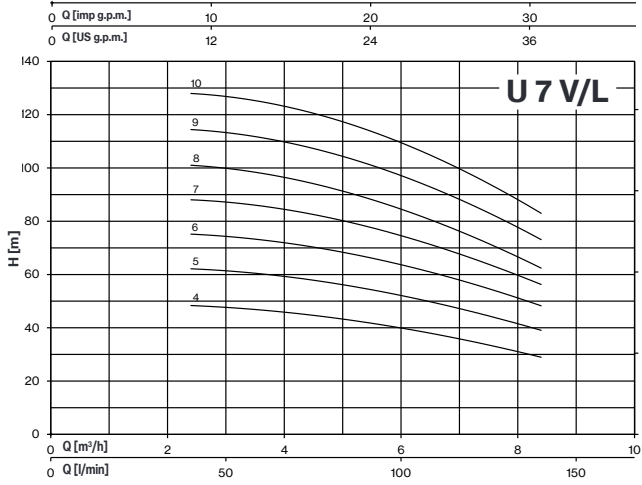

ULTRA LG

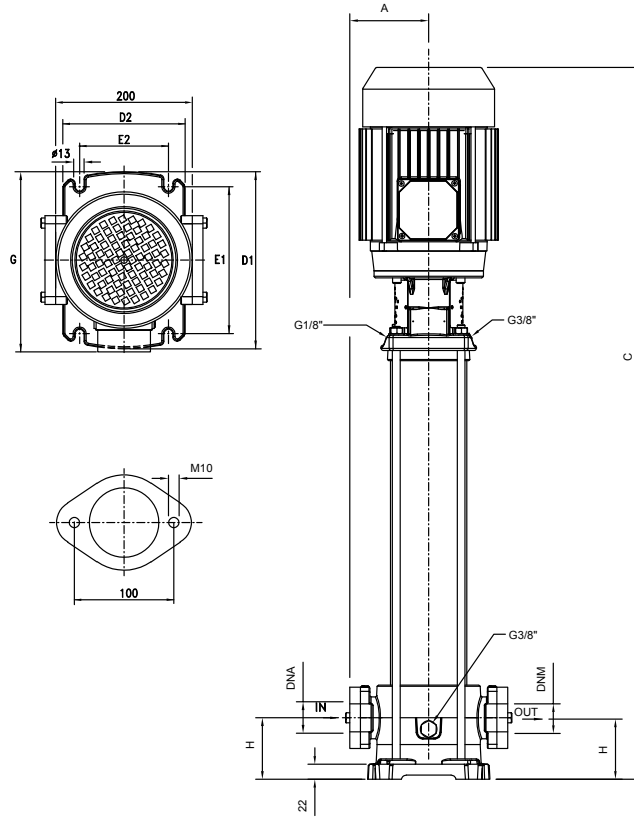



ULTRA LG	DIMENSIONS (mm)										Kg
	A	C	D1	D2	E1	E2	G	H	DNA	DNM	
U 18LG-920/10 T	118	1072	260	180	215	130	307	90			67,5
U 18LG-1000/11 T	118	1057	260	180	215	130	307	90	2" G	2" G	75,5

MODEL	LOTS			
	TRUCK		CONTAINER	
	PALLET (cm)	N° pumps	PALLET (cm)	N° pumps
U 18LG-920/10 T - 1000/11 T	100×120×150	12	100×120×150	12



ULTRA V-SV-L-SL-LG-SLG Serie-Mechanical seal and bearings

MECHANICAL SEAL	PUMP MODEL	SHAFT Ø		STANDARD MATERIAL	OPTIONAL
	U3-100/5, U3-120/6, U5-120/4, U5-150/5, U5-180/6, U7-180/4, U7-250/5, U7-300/6, U9-200/4, U9-250/5, U18-250/3, U18-400/4	14mm / S	Rotating face Stationary face Elastomer	Graphite Ceramic EPDM	SiC SiC EPDM
	U3-150/7, U3-180/8, U3-200/9, U3-250/10, U3-280/11, U3-300/12, U5-200/7, U5-250/8, U5-280/9, U5-300/10, U5-350/11, U5-380/12, U7-350/7, U7-400/8, U7-450/9, U7-550/10, U9-300/6, U9-400/7, U9-450/8, U9-500/9, U9-550/10	14mm	Rotating face Stationary face Elastomer	Graphite SiC EPDM	SiC SiC EPDM
	U18-450/5, U18-550/6, U18-750/8, U18-900/9, U18-920/10, U18-1000/11	14mm / L	Rotating face Stationary face Elastomer	Graphite SiC EPDM	SiC SiC EPDM
	U3-350/14, U3-380/16, U3-400/18, U3-450/20, U5-400/14, U5-450/16, U5-550/18, U5-600/20, U7-750/12, U7-800/14, U7-900/16, U7-950/18, U7-1000/20, U9-750/12, U9-800/14, U9-900/16, U9-950/18, U9-1000/20	14mm / Balanced seal	Rotating face Stationary face Elastomer	Tungsten carbide Graphite EPDM	- - -

BEARINGS	PUMP MODEL	TYPE	
	U3-100/5, U3-120/6, U5-120/4	6202-ZZ	6302-ZZ C3
	U3-150/7, U3-180/8, U3-200/9, U3-250/10, 3- U3-280/11, 3- U3-300/12, U5-150/5, U5-180/6, U5-200/7, U5-250/8, 3- U5-280/9, 3- U5-300/10, U7-180/4, U7-250/5, 3- U7-300/6, U9-200/4, U9-250/5, 3- U9-300/6, U18-250/3	6204-ZZ	6304-ZZ C3
	1- U3-280/11, 1- U3-300/12, 1- U5-280/9, 1- U5-300/10, U5-350/11, U5-380/12, 1- U7-300/6, U7-350/7, U7-400/8, 1- U9-300/6, U9-400/7, U18-400/4, U3-350/14, U3-380/16, U3-400/18, U5-400/14	6203-ZZ	6305-ZZ C3
	U7-450/9, U7-550/10, U9-450/8, U9-500/9, U9-550/10, U18-450/5, U18-550/6	6204-ZZ	6306-ZZ-C3
	U3-450/20, U5-450/16, U5-550/18, U5-600/20	6204-ZZ	3206-ZZ C3
	U7-750/12, U7-800/14, U7-900/16, U9-750/12, U9-800/14, U9-900/16, U18-750/8, U18-900/9, U18-920/10	6206-ZZ C3	3306-ZZ C3
	U7-950/18, U7-1000/20, U9-950/18, U9-1000/20, U18-1000/11	6206-ZZ C3	3308-ZZ C3



ULTRA+VSD

Vertical booster pump with variable speed



DESCRIPTION

Horizontal pump of ULTRA series provided with variable speed drive EPIC or IPFC. This booster pump assure the desired pressure regardless changes on flow demand making it suitable for low or missing pressure in residential systems and industrial applications. It is required the installation of a membrane tank downstream the system.

FEATURES

- EPIC or IPFC variable speed drive
- Vertical pump of ULTRA series
- Pressure sensor wired to the vsd
- Cable with plug for EPIC vsd only

FUNCTIONING

If the pressure in the network drops the pump will starts and gradually speeds up to provide with the set pressure. When the water demand decreases, the pressure will rise causing the pump speed to slow down and eventually to stop the pump if demand ceases. The pump will remain on standby waiting to start at the next water demand.

SELECTION

The table below shows the vertical ULTRA pump models available for the assembly with EPIC or IPFC. Consult the catalog at the ULTRA series for pump specifics and characteristic curves.



PUMP								VSD		
TYPE	MODEL	Version						TYPE	Power system	
		V	SV	L	SL/SLX	LG	SLG/SLGX		in	out
U 3	100/5T	■	■	■	■	-	-	EPIC	1-230	3-230
		■	■	■	■	-	-	IPFC109	1-230	3-230
		■	■	■	■	-	-	IPFC306	3-400	3-400
	120/6T	■	■	■	■	-	-	EPIC	1-230	3-230
		■	■	■	■	-	-	IPFC109	1-230	3-230
		■	■	■	■	-	-	IPFC306	3-400	3-400
	150/7T	■	■	■	■	-	-	EPIC	1-230	3-230
		■	■	■	■	-	-	IPFC109	1-230	3-230
		■	■	■	■	-	-	IPFC306	3-400	3-400
	180/8T	■	■	■	■	-	-	EPIC	1-230	3-230
		■	■	■	■	-	-	IPFC109	1-230	3-230
		■	■	■	■	-	-	IPFC306	3-400	3-400
	200/9T	■	■	■	■	-	-	EPIC	1-230	3-230
		■	■	■	■	-	-	IPFC109	1-230	3-230
■		■	■	■	-	-	IPFC306	3-400	3-400	
250/10T	■	■	■	■	-	-	EPIC	1-230	3-230	
	■	■	■	■	-	-	IPFC114	1-230	3-230	
	■	■	■	■	-	-	IPFC306	3-400	3-400	
280/11T	-	■	-	■	-	-	EPIC	1-230	3-230	
	■	■	■	■	-	-	IPFC114	1-230	3-230	
	■	■	■	■	-	-	IPFC306	3-400	3-400	
300/12T	■	■	■	■	-	-	IPFC114	1-230	3-230	
	■	■	■	■	-	-	IPFC306	3-400	3-400	
	-	-	-	-	-	■	IPFC114	1-230	3-230	
350/14T	-	-	-	-	-	■	IPFC306	3-400	3-400	
	-	-	-	-	-	■	IPFC114	1-230	3-230	
	-	-	-	-	-	■	IPFC309	3-400	3-400	
380/16T	-	-	-	-	-	■	IPFC309	3-400	3-400	
	-	-	-	-	-	■	IPFC309	3-400	3-400	
	-	-	-	-	-	■	IPFC309	3-400	3-400	
U 5	120/4T	■	■	■	■	-	-	EPIC	1-230	3-230
		■	■	■	■	-	-	IPFC109	1-230	3-230
		■	■	■	■	-	-	IPFC306	3-400	3-400
	150/5T	■	■	■	■	-	-	EPIC	1-230	3-230
		■	■	■	■	-	-	IPFC109	1-230	3-230
		■	■	■	■	-	-	IPFC306	3-400	3-400
	180/6T	■	■	■	■	-	-	EPIC	1-230	3-230
		■	■	■	■	-	-	IPFC109	1-230	3-230
		■	■	■	■	-	-	IPFC306	3-400	3-400
	200/7T	■	■	■	■	-	-	EPIC	1-230	3-230
		■	■	■	■	-	-	IPFC109	1-230	3-230
		■	■	■	■	-	-	IPFC306	3-400	3-400
	250/8T	■	■	■	■	-	-	EPIC	1-230	3-230
		■	■	■	■	-	-	IPFC114	1-230	3-230
■		■	■	■	-	-	IPFC306	3-400	3-400	
280/9T	■	■	■	■	-	-	IPFC114	1-230	3-230	
	■	■	■	■	-	-	IPFC306	3-400	3-400	
	■	■	■	■	-	-	IPFC114	1-230	3-230	
300/10T	■	■	■	■	-	-	IPFC306	3-400	3-400	
	■	■	■	■	-	-	IPFC114	1-230	3-230	
	■	■	■	■	-	-	IPFC306	3-400	3-400	
350/11T	■	■	■	■	-	-	IPFC114	1-230	3-230	
	■	■	■	■	-	-	IPFC306	3-400	3-400	
	■	■	■	■	-	-	IPFC309	3-400	3-400	
380/12T	■	■	■	■	-	-	IPFC309	3-400	3-400	
	-	-	-	-	-	■	IPFC309	3-400	3-400	
	-	-	-	-	-	■	IPFC309	3-400	3-400	
400/14T	-	-	-	-	-	■	IPFC309	3-400	3-400	
	-	-	-	-	-	■	IPFC309	3-400	3-400	
	-	-	-	-	-	■	IPFC309	3-400	3-400	
450/16T	-	-	-	-	-	■	IPFC309	3-400	3-400	
	-	-	-	-	-	■	IPFC309	3-400	3-400	
	-	-	-	-	-	■	IPFC309	3-400	3-400	
550/18T	-	-	-	-	-	■	IPFC309	3-400	3-400	
	-	-	-	-	-	■	IPFC309	3-400	3-400	
	-	-	-	-	-	■	IPFC309	3-400	3-400	
600/20T	-	-	-	-	-	■	IPFC311	3-400	3-400	
	-	-	-	-	-	■	IPFC311	3-400	3-400	
	-	-	-	-	-	■	IPFC311	3-400	3-400	



ULTRA+VSD

PUMP								VSD		
TYPE	MODEL	Version						TYPE	Power system	
		V	SV	L	SL/SLX	LG	SLG/SLGX		in	out
U 7	180/4T	■	■	■	■	-	-	EPIC	1-230	3-230
		■	■	■	■	-	-	IPFC109	1-230	3-230
		■	■	■	■	-	-	IPFC306	3-400	3-400
	250/5T	■	■	■	■	-	-	IPFC114	1-230	3-230
		■	■	■	■	-	-	IPFC306	3-400	3-400
	300/6T	■	■	■	■	-	-	IPFC114	1-230	3-230
		■	■	■	■	-	-	IPFC306	3-400	3-400
	350/7T	■	■	■	■	-	-	IPFC114	1-230	3-230
		■	■	■	■	-	-	IPFC306	3-400	3-400
	400/8T	■	■	■	■	-	-	IPFC309	3-400	3-400
	450/9T	■	■	■	■	-	-	IPFC309	3-400	3-400
	550/10T	■	■	■	■	-	-	IPFC311	3-400	3-400
750/12T	-	-	-	-	-	■	IPFC311	3-400	3-400	
800/14T	-	-	-	-	-	■	IPFC314	3-400	3-400	
900/16T	-	-	-	-	-	■	IPFC314	3-400	3-400	
950/18T	-	-	-	-	-	■	IPFC318	3-400	3-400	
1000/20T	-	-	-	-	-	■	IPFC318	3-400	3-400	
U 9	200/4T	■	■	■	■	-	-	EPIC	1-230	3-230
		■	■	■	■	-	-	IPFC109	1-230	3-230
		■	■	■	■	-	-	IPFC306	3-400	3-400
	250/5T	■	■	■	■	-	-	EPIC	1-230	3-230
		■	■	■	■	-	-	IPFC114	1-230	3-230
	300/6T	■	■	■	■	-	-	IPFC306	3-400	3-400
		■	■	■	■	-	-	IPFC114	1-230	3-230
	400/7T	■	-	■	-	-	-	IPFC306	3-400	3-400
		■	-	■	-	-	-	IPFC309	3-400	3-400
	450/8T	■	■	■	■	-	-	IPFC309	3-400	3-400
	500/9T	■	■	■	■	-	-	IPFC309	3-400	3-400
	550/10T	■	■	■	■	-	-	IPFC311	3-400	3-400
	750/12T	-	-	-	-	-	■	IPFC311	3-400	3-400
	800/14T	-	-	-	-	-	■	IPFC314	3-400	3-400
900/16T	-	-	-	-	-	■	IPFC314	3-400	3-400	
950/18T	-	-	-	-	-	■	IPFC318	3-400	3-400	
1000/20T	-	-	-	-	-	■	IPFC318	3-400	3-400	



PUMP									VSD		
TYPE	MODEL	Version							TYPE	Power system	
		V	SV	L	SL/SLX	LG	HS	HX		in	out
U 18	100/1T	-	-	-	-	-	-	■	IPFC109	1-230	3-230
		-	-	-	-	-	-	■	IPFC306	3-400	3-400
	200/2T	-	-	-	-	-	-	■	IPFC109	1-230	3-230
		-	-	-	-	-	-	■	IPFC306	3-400	3-400
	250/3T	■	■	■	■	-	-	-	EPIC	1-230	3-230
		■	■	■	■	-	-	-	IPFC114	1-230	3-230
		■	■	■	■	-	-	-	IPFC306	3-400	3-400
	300/3T	-	-	-	-	-	-	■	IPFC114	1-230	3-230
		-	-	-	-	-	-	■	IPFC306	3-400	3-400
	400/4T	■	■	■	■	-	-	■	IPFC114	1-230	3-230
		■	■	■	■	-	-	■	IPFC306	3-400	3-400
	450/5T	■	■	■	■	-	-	-	IPFC309	3-400	3-400
	550/5T	-	-	-	-	-	-	■	IPFC309	3-400	3-400
	550/6T	■	■	■	■	-	-	-	IPFC311	3-400	3-400
	750/6T	-	-	-	-	-	-	■	IPFC311	3-400	3-400
	750/7T	-	-	-	-	-	-	■	IPFC311	3-400	3-400
	750/8T	■	■	■	■	-	-	-	IPFC314	3-400	3-400
	900/9T	■	■	■	■	-	-	-	IPFC318	3-400	3-400
	920/10T	-	-	-	-	■	-	-	IPFC318	3-400	3-400
	1000/8T	-	-	-	-	-	-	■	IPFC314	3-400	3-400
1000/9T	-	-	-	-	-	-	■	IPFC314	3-400	3-400	
1000/11T	-	-	-	-	■	-	-	IPFC318	3-400	3-400	
1500/10T	-	-	-	-	-	-	■	IPFC318	3-400	3-400	
1500/11T	-	-	-	-	-	-	■	IPFC318	3-400	3-400	
1500/12T	-	-	-	-	-	-	■	IPFC325	3-400	3-400	
1500/13T	-	-	-	-	-	-	■	IPFC325	3-400	3-400	
1500/14T	-	-	-	-	-	-	■	IPFC325	3-400	3-400	
2000/15T	-	-	-	-	-	-	■	IPFC325	3-400	3-400	
2000/16T	-	-	-	-	-	-	■	IPFC325	3-400	3-400	
2000/17T	-	-	-	-	-	-	■	IPFC330	3-400	3-400	
U 22	200/1T	-	-	-	-	-	-	■	IPFC109	1-230	3-230
		-	-	-	-	-	-	■	IPFC306	3-400	3-400
	300/2T	-	-	-	-	-	-	■	IPFC114	1-230	3-230
		-	-	-	-	-	-	■	IPFC306	3-400	3-400
	400/3T	-	-	-	-	-	-	■	IPFC309	3-400	3-400
	550/4T	-	-	-	-	-	-	■	IPFC311	3-400	3-400
	750/5T	-	-	-	-	-	-	■	IPFC311	3-400	3-400
	1000/6T	-	-	-	-	-	-	■	IPFC314	3-400	3-400
	1000/7T	-	-	-	-	-	-	■	IPFC318	3-400	3-400
	1500/8T	-	-	-	-	-	-	■	IPFC318	3-400	3-400
	1500/9T	-	-	-	-	-	-	■	IPFC325	3-400	3-400
	1500/10T	-	-	-	-	-	-	■	IPFC325	3-400	3-400
	2000/11T	-	-	-	-	-	-	■	IPFC325	3-400	3-400
	2000/12T	-	-	-	-	-	-	■	IPFC325	3-400	3-400
2000/13T	-	-	-	-	-	-	■	IPFC330	3-400	3-400	
2000/14T	-	-	-	-	-	-	■	IPFC330	3-400	3-400	



ULTRA+VSD

		PUMP							VSD		
TYPE	MODEL	Version							TYPE	Power system	
		V	SV	L	SL/SLX	LG	HS	HX		in	out
U 35	300/1T	-	-	-	-	-	■	■	IPFC114	1-230	3-230
		-	-	-	-	-	■	■	IPFC306	3-400	3-400
	550/2-2RT	-	-	-	-	-	■	■	IPFC309	3-400	3-400
	550/2-1RT	-	-	-	-	-	■	■	IPFC309	3-400	3-400
	750/2T	-	-	-	-	-	■	■	IPFC311	3-400	3-400
	750/3-2RT	-	-	-	-	-	■	■	IPFC311	3-400	3-400
	1000/3-1RT	-	-	-	-	-	■	■	IPFC314	3-400	3-400
	1000/3T	-	-	-	-	-	■	■	IPFC314	3-400	3-400
	1000/4-2RT	-	-	-	-	-	■	■	IPFC318	3-400	3-400
	1500/4-1RT	-	-	-	-	-	■	■	IPFC318	3-400	3-400
	1500/4T	-	-	-	-	-	■	■	IPFC325	3-400	3-400
	1500/5-2RT	-	-	-	-	-	■	■	IPFC325	3-400	3-400
	1500/5-1RT	-	-	-	-	-	■	■	IPFC325	3-400	3-400
	2000/5T	-	-	-	-	-	■	■	IPFC325	3-400	3-400
	2000/6-2RT	-	-	-	-	-	■	■	IPFC325	3-400	3-400
	2000/6-1RT	-	-	-	-	-	■	■	IPFC330	3-400	3-400
2000/6T	-	-	-	-	-	■	■	IPFC330	3-400	3-400	
2000/7-2RT	-	-	-	-	-	■	■	IPFC330	3-400	3-400	
2000/7-1RT	-	-	-	-	-	■	■	IPFC330	3-400	3-400	
U 50	400/1-1RT	-	-	-	-	-	■	■	IPFC114	1-230	3-230
		-	-	-	-	-	■	■	IPFC306	3-400	3-400
	550/1T	-	-	-	-	-	■	■	IPFC309	3-400	3-400
	750/2-2RT	-	-	-	-	-	■	■	IPFC311	3-400	3-400
	1000/2T	-	-	-	-	-	■	■	IPFC318	3-400	3-400
	1500/3-2RT	-	-	-	-	-	■	■	IPFC325	3-400	3-400
	1500/3T	-	-	-	-	-	■	■	IPFC318	3-400	3-400
	2000/4-2RT	-	-	-	-	-	■	■	IPFC325	3-400	3-400
2000/4T	-	-	-	-	-	■	■	IPFC330	3-400	3-400	
U 75	550/1-1RT	-	-	-	-	-	■	■	IPFC309	3-400	3-400
	750/1T	-	-	-	-	-	■	■	IPFC311	3-400	3-400
	1000/2-2RT	-	-	-	-	-	■	■	IPFC318	3-400	3-400
	1500/2-1RT	-	-	-	-	-	■	■	IPFC318	3-400	3-400
	1500/2T	-	-	-	-	-	■	■	IPFC325	3-400	3-400
	2000/3-2RT	-	-	-	-	-	■	■	IPFC325	3-400	3-400
	2000/3-1RT	-	-	-	-	-	■	■	IPFC330	3-400	3-400
U 90	750/1-1RT	-	-	-	-	-	■	■	IPFC311	3-400	3-400
	1000/1T	-	-	-	-	-	■	■	IPFC318	3-400	3-400
	1500/2-2RT	-	-	-	-	-	■	■	IPFC325	3-400	3-400
	2000/2T	-	-	-	-	-	■	■	IPFC330	3-400	3-400

