



Monobloc horizontal centrifugal pumps. Widely used in water supplies, pressurization, cooling, and industrial applications. Their flat curve guarantees small change in pressure drop for large change in flow.

Construction features

Pump body	stainless steel AISI 304
Motor bracket	cast iron
Impeller	stainless steel AISI 304
Mechanical seal	ceramic-graphite-NBR
Mechanical seal housing	stainless steel AISI 304
Pump shaft end	stainless steel AISI 304
Liquid temperature	-10 ÷ +90 °C
Operating pressure	max 10 bar

Motor

2 poles induction motor	3~ 230/400V-50Hz P ≤ 4kW
	3~ 400/690V-50Hz P > 4kW
	1~ 230V-50Hz
Insulation class	F
Protection degree	IPX5
Motor efficiency	IE3

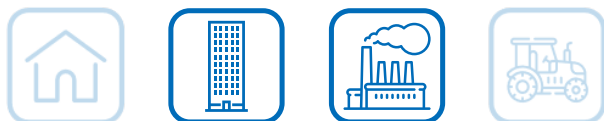
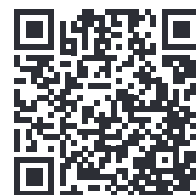

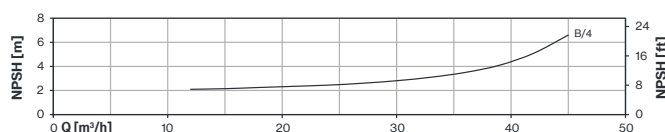
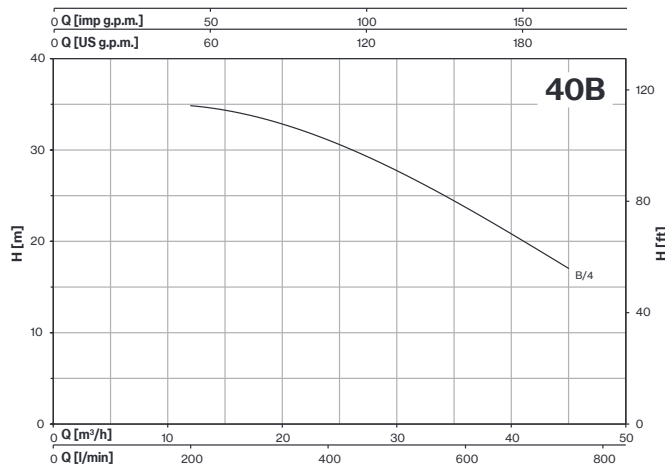
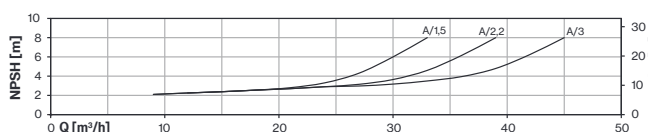
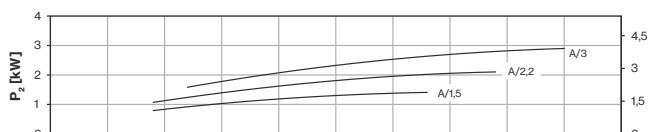
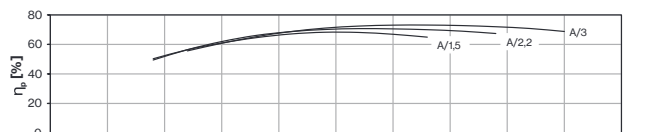
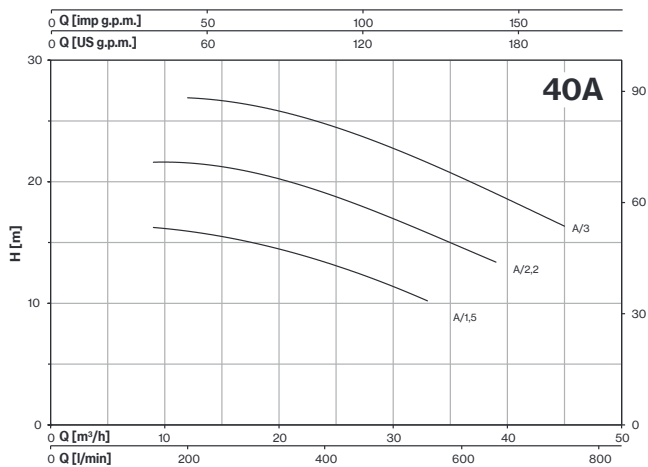
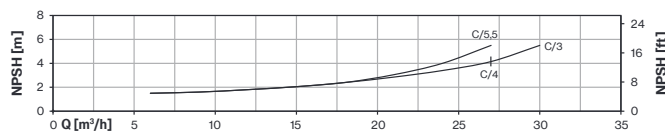
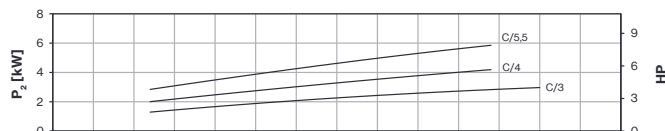
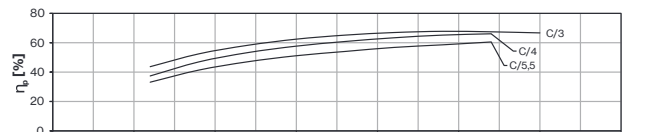
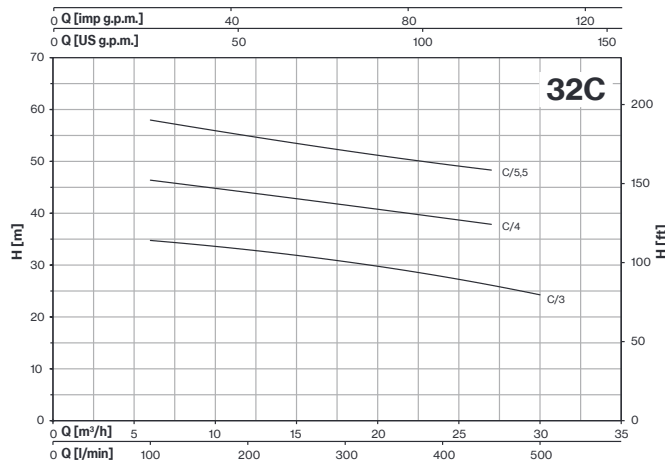
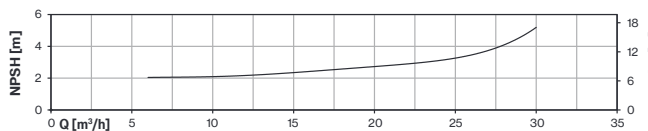
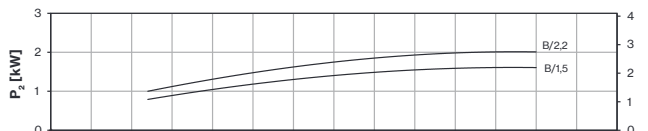
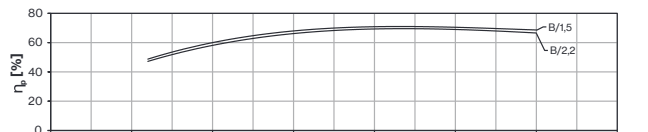
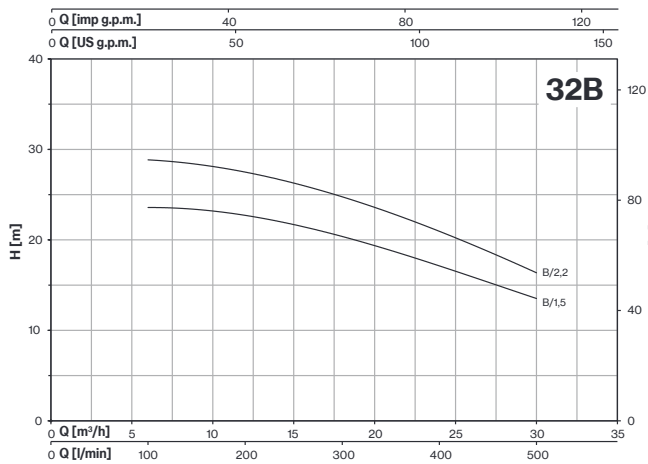

CMS

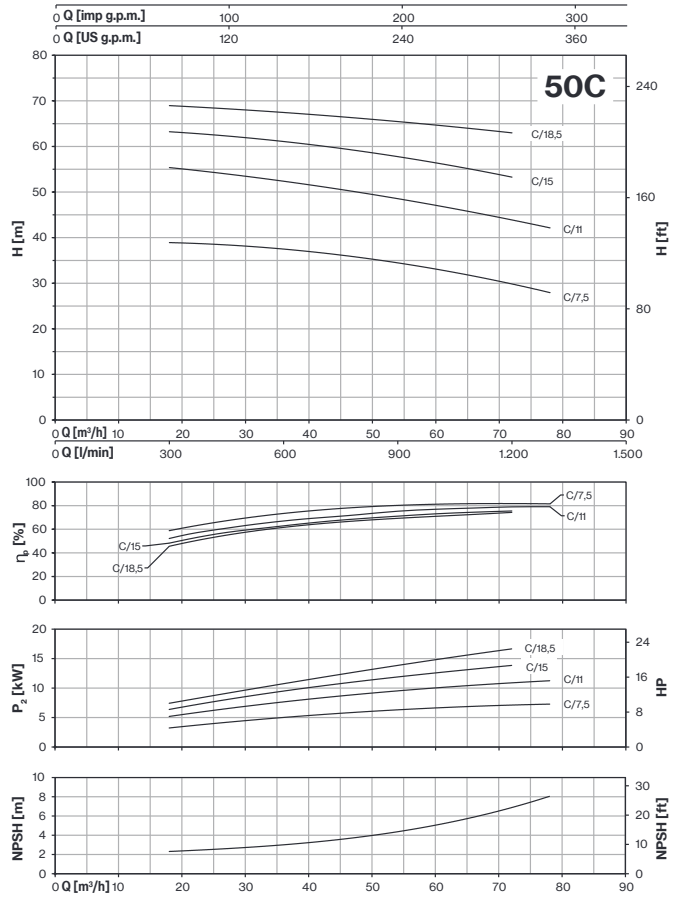
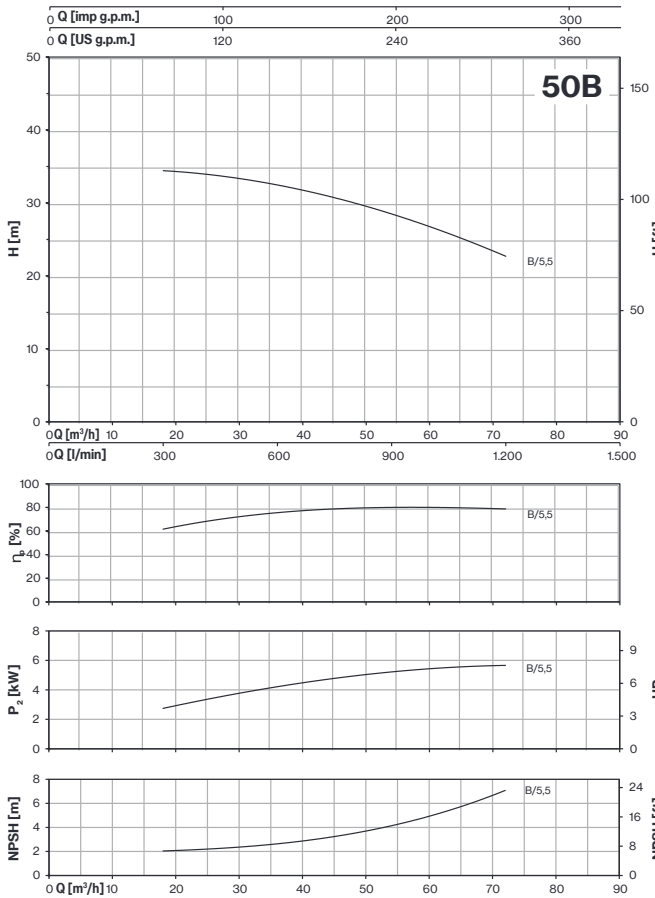
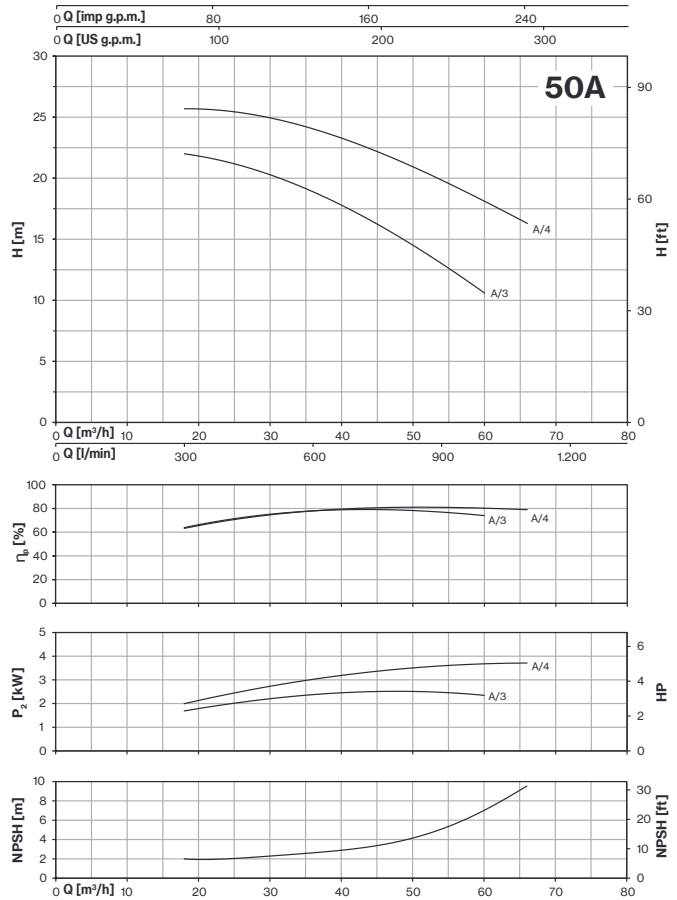
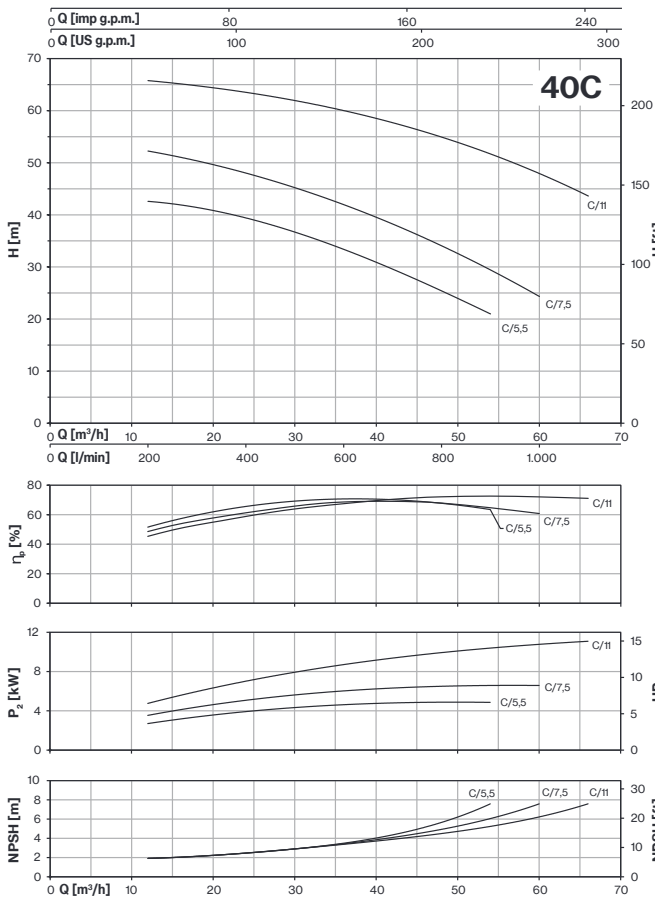

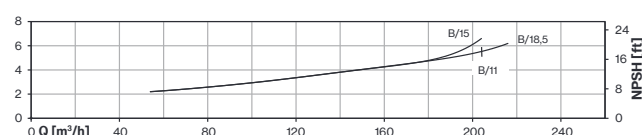
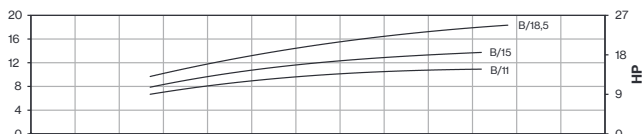
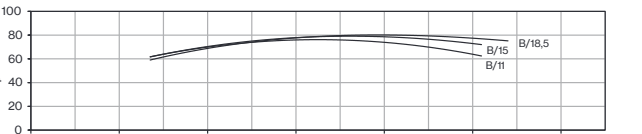
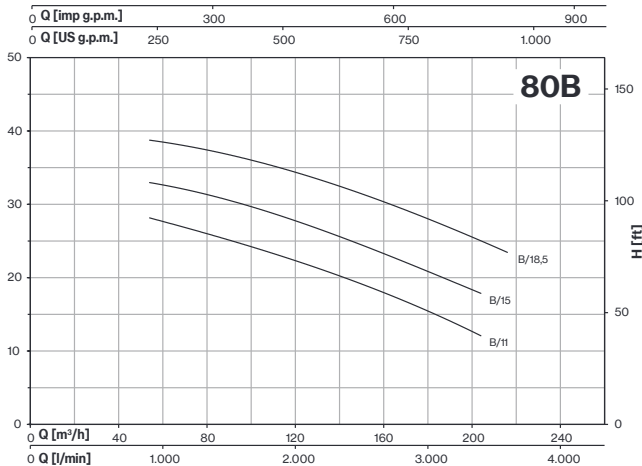
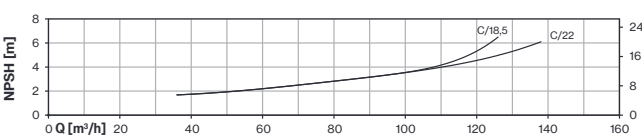
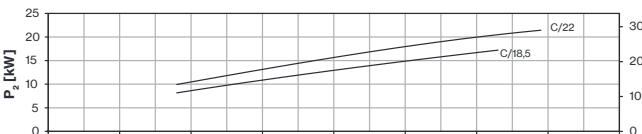
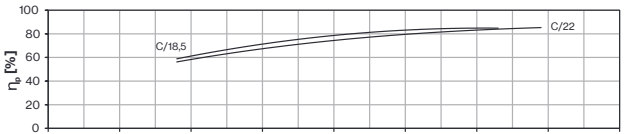
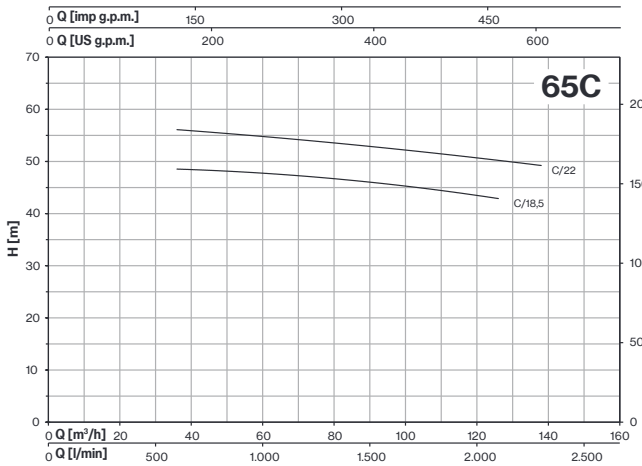
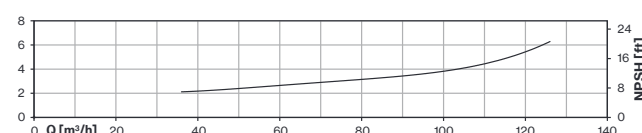
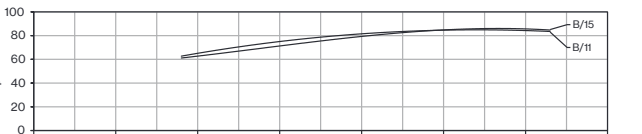
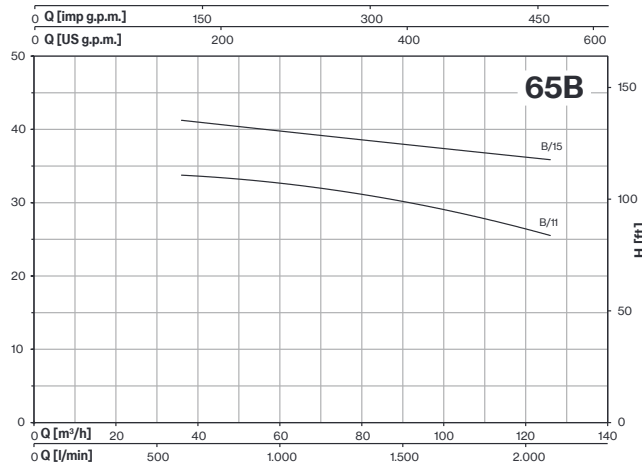
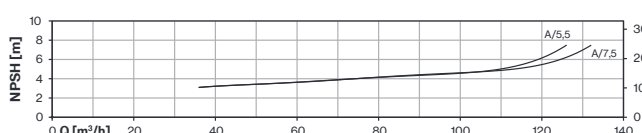
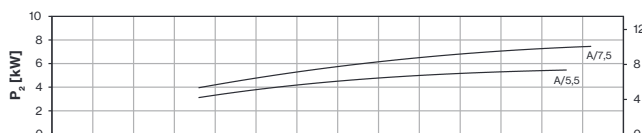
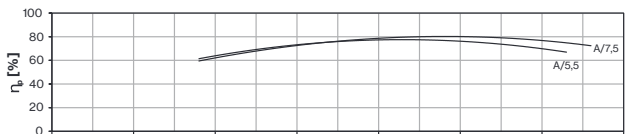
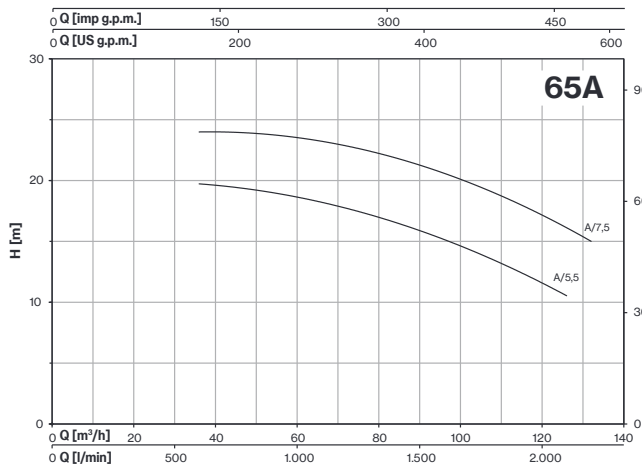

CMS

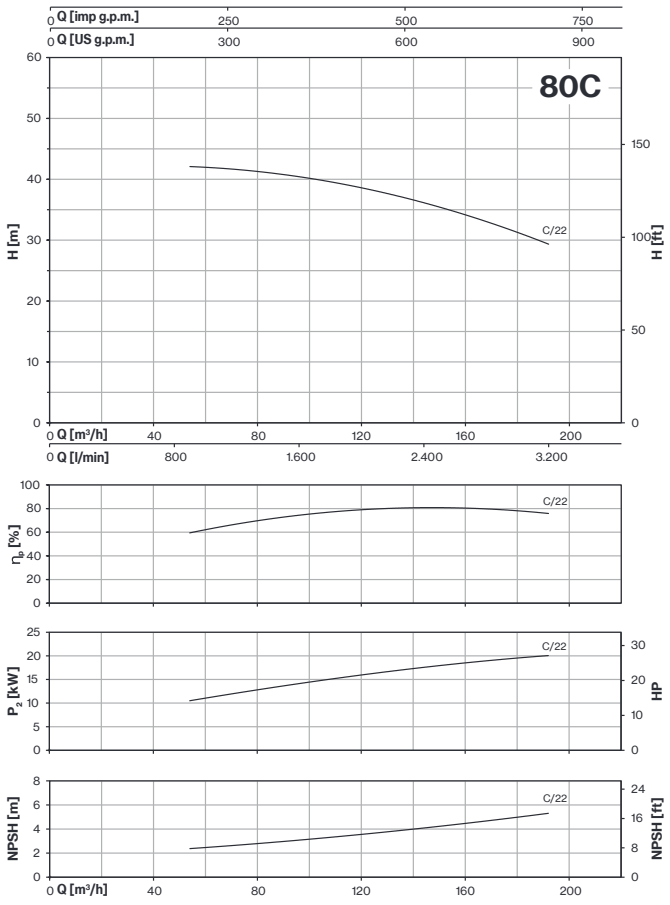

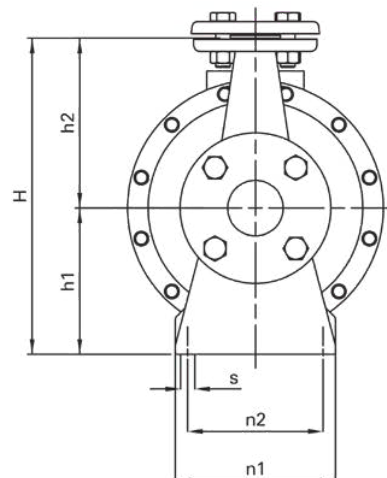
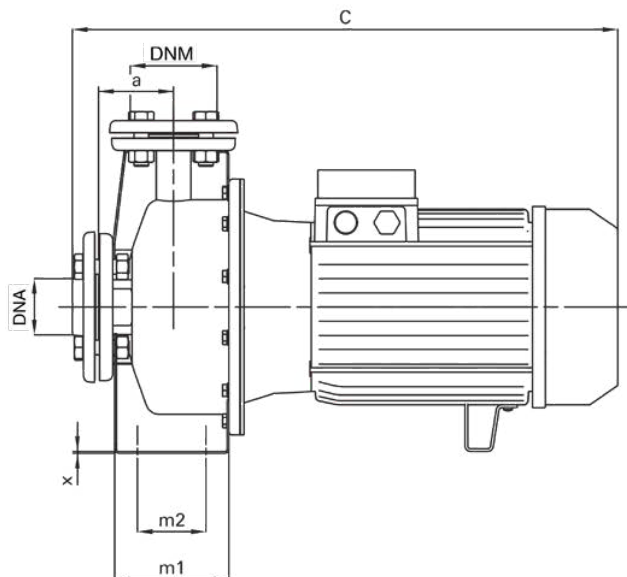

TYPE	DIMENSIONS (mm)															Kg			
	a	h1	h2	m1	m2	n1	n2	x	s	C	H	DNA	DNM	I	L		M		
32B/1,5	82	132	144	125	75	175	148	2	10	530	276	50	32	555	255	345	29		
32B/1,5m	82	132	144	125	75	175	148	2	10	530	276			555	255	345	30,5		
32B/2,2	82	132	144	125	75	175	148	2	10	530	276			555	255	345	31,5		
32B/2,2m	82	132	144	125	75	175	148	2	10	530	276			555	255	345	35		
32C/3	82	160	186	125	75	175	148	2	10	535	346			625	310	430	37		
32C/4	82	160	186	125	75	175	148	2	10	555	346			625	310	430	44,5		
32C/4m	82	160	186	125	75	175	148	2	10	600	346			625	310	430	53		
32C/5,5	82	160	186	125	75	175	148	2	10	600	346			625	310	430	53,5		
40A/1,5	82	132	142	125	75	175	148	2	10	535	274	65	40	555	255	345	29,5		
40A/1,5m	82	132	142	125	75	175	148	2	10	535	274			555	255	345	31		
40A/2,2	82	132	142	125	75	175	148	2	10	535	274			555	255	345	32		
40A/2,2m	82	132	142	125	75	175	148	2	10	535	274			555	255	345	35,5		
40A/3	82	132	142	125	75	175	148	2	10	535	274			555	255	345	35,5		
40B/4	82	132	142	125	75	175	148	2	10	550	274			555	255	345	43,5		
40B/4m	82	132	142	125	75	175	148	2	10	595	274			555	255	345	51,5		
40C/5,5	100	160	180	140	93	175	148	2	10	615	340			625	310	430	54		
40C/7,5	100	160	180	140	93	175	148	2	10	615	340	625	310	430	60				
40C/11	100	160	180	140	93	175	148	2	10	645	340	670	350	525	83,5				
50A/3	86	132	166	125	75	175	148	2	10	535	298	65	50	555	255	345	36		
50A/4	86	132	166	125	75	175	148	2	10	555	298			555	255	345	43,5		
50A/4m	86	132	166	125	75	175	148	2	10	600	298			555	255	345	52		
50B/5,5	100	160	180	140	93	175	148	2	10	615	340			625	310	430	54		
50C/7,5	100	160	180	140	93	175	148	2	10	615	340			625	310	430	60		
50C/11	100	160	180	140	93	175	148	2	10	645	340			670	350	525	83,5		
50C/15	100	160	180	140	93	175	148	2	10	725	340			820	360	525	115		
50C/18,5	100	160	180	140	93	175	148	2	10	770	340			820	360	525	129		
65A/5,5	100	160	180	140	93	175	148	2	10	615	340	80	65	625	310	430	53,5		
65A/7,5	100	160	180	140	93	175	148	2	10	615	340			625	310	430	59,5		
65B/11	100	160	200	140	93	175	148	2	10	645	360			670	350	525	85		
65B/15	100	160	200	140	93	175	148	2	10	725	360			670	350	525	116		
65C/18,5	100	160	225	140	93	175	148	2	10	770	385			670	350	525	130,5		
65C/22	100	160	225	140	93	175	148	2	10	770	340			670	350	525	141		
80B/11	125	160	225	167	93	175	148	2	10	685	385			100	80	670	350	525	87
80B/15	125	160	225	167	93	175	148	2	10	765	385					670	350	525	118
80B/18,5	125	160	225	167	93	175	148	2	10	810	385	870	400			570	132,5		
80C/22	125	160	250	167	93	175	148	2	10	810	410	870	400			570	143		

CMS Serie-Mechanical seal and bearings

MECHANICAL SEAL	PUMP MODEL	SHAFT Ø		STANDARD MATERIAL	OPTIONAL			
	CMS32B/1,5 - CMS32B/2,2 - CMS32C/3 - CMS40A/1,5 - CMS40A/2,2 - CMS40A/3 - CMS50A/3	20mm	Rotating face Stationary face Elastomer	Ceramic Graphite NBR	Ceramic Graphite EPDM	- - -	SiC SiC EPDM	SiC SiC FKM
	CMS32C/4 - CMS32C/5,5 - CMS40B/4 - CMS40C/5,5 - CMS40C/7,5 - CMS40C/11 - CMS50A/4 - CMS50B/5,5 - CMS50C/7,5 - CMS50C/11 - CMS50C/15 - CMS50C/18,5 - CMS65A/5,5 - CMS65A/7,5 - CMS65B/11 - CMS65B/15 - CMS65C/18,5 - CMS65C/22 - CMS80B/11 - CMS80B/15 - CMS80B/18,5 - CMS80C/22	28mm	Rotating face Stationary face Elastomer	Ceramic Graphite NBR	Ceramic Graphite EPDM	Ceramic Graphite FKM	SiC SiC EPDM	SiC SiC FKM

BEARINGS	PUMP MODEL	TYPE	
	3-CMS32C/4 - 3-CMS40B/4 - 3-CMS50A/4	6204-ZZ	6206-ZZ C3
	CMS32B/1,5 - CMS32B/2,2 - CMS32C/3 - CMS40A/1,5 - CMS40A/2,2 - CMS40A/3 - CMS50A/3	6205-ZZ C3	6203-ZZ
	1-CMS32C/4m - CMS32C/5,5 - 1-CMS40B/4m - CMS40C/5,5 - CMS40C/7,5 - 1-CMS50A/4m - CMS50B/5,5 - CMS50C/7,5 - CMS65A/5,5 - CMS65A/7,5	6206-ZZ C3	6306-ZZ C3
	CMS40C/11 - CMS50C/11 - CMS65B/11 - CMS80B/11	6206-ZZ C3	6308-ZZ C3
	CMS50C/15 - CMS50C/18,5 - CMS65B/15 - CMS65C/18,5 - CMS65C/22 - CMS80B/15 - CMS80B/18,5 - CMS80C/22	6308-ZZ C3	6309-ZZ C3

